

# METHANE ADVISORY PANEL

Fall, 2019

Convened by

New Mexico Environment Department

and

New Mexico Energy, Minerals and Natural Resources Department

TEAM LEAD CONTACT INFORMATION			
<p>Sandra Ely Environmental Protection Division Director New Mexico Environment Department 1190 St. Francis Drive PO Box 5469 Santa Fe, New Mexico (505)827- 2820 Office (505)629-6307 Cell <a href="mailto:Sandra.Ely@state.nm.us">Sandra.Ely@state.nm.us</a></p>	<p>Adrienne Sandoval Oil Conservation Division Director 1220 S. St. Francis Dr. Santa Fe, NM 87505 (505)476-3441 Office <a href="mailto:Adrienne.Sandoval@state.nm.us">Adrienne.Sandoval@state.nm.us</a></p>	<p>Liz Bisbey-Kuehn Bureau Chief New Mexico Environment Department Air Quality Bureau 525 Camino de los Marquez, Suite 1 Santa Fe, NM 87505-1816 Office: (505) 476-4305 Cell: (505) 670-9279 <a href="mailto:Elizabeth.Kuehn@state.nm.us">Elizabeth.Kuehn@state.nm.us</a></p>	<p>Julia Barnes Facilitator 200 West De Vargas, Suite 2 Santa Fe, NM 87501 (505) 470-7349 Cell <a href="mailto:Jhbnm1@gmail.com">Jhbnm1@gmail.com</a>  April Elliott <a href="mailto:april@elliottanalytics.com">april@elliottanalytics.com</a></p>
PARTICIPATING STATE AGENCY – STATE LAND OFFICE			
<p>Jordan Kessler Assistant Commissioner of Mineral Resources Work: 505 827-5746 Cell: 505 365-3800 <a href="mailto:jkessler@slo.state.nm.us">jkessler@slo.state.nm.us</a></p>			

# Table of Contents

<b>INTRODUCTION .....</b>	<b>5</b>
<b>METHANE ADVISORY PANEL MEMBERS.....</b>	<b>6</b>
<b>SECTION 1, PNEUMATIC CONTROLLERS/PUMPS.....</b>	<b>7</b>
1. DESCRIPTION OF PROCESS AND EQUIPMENT.....	7
2. INFORMATION ON EQUIPMENT OR PROCESS COSTS, SOURCES OF METHANE EMISSIONS, AND REDUCTION OR CONTROL OPTIONS .....	11
3. IMPLEMENTATION .....	27
4. CHALLENGES AND OPPORTUNITIES TO ACHIEVE METHANE REDUCTION IN NEW MEXICO .....	28
5. PNEUMATICS PATH FORWARD .....	30
<b>SECTION 2, LEAK DETECTION AND REPAIR.....</b>	<b>34</b>
1. DESCRIPTION OF PROCESS AND EQUIPMENT.....	34
2. INFORMATION ON EQUIPMENT OR PROCESS COSTS, SOURCES OF METHANE EMISSIONS, AND REDUCTION OR CONTROL OPTIONS .....	36
3. IMPLEMENTATION .....	62
4. CHALLENGES AND OPPORTUNITIES TO ACHIEVE METHANE REDUCTION IN NEW MEXICO .....	63
5. LDAR PATH FORWARD .....	65
<b>SECTION 3, DEHYDRATION UNITS .....</b>	<b>68</b>
1. DESCRIPTION OF PROCESS AND EQUIPMENT.....	68
2. INFORMATION ON EQUIPMENT OR PROCESS COSTS, SOURCES OF METHANE EMISSIONS, AND REDUCTION OR CONTROL OPTIONS .....	71
3. IMPLEMENTATION .....	81
4. CHALLENGES AND OPPORTUNITIES TO ACHIEVE METHANE REDUCTION IN NEW MEXICO .....	81
5. DEHYDRATORS - PATH FORWARD .....	83
<b>SECTION 4, COMPRESSORS AND ENGINES.....</b>	<b>84</b>
1. DESCRIPTION OF PROCESS AND EQUIPMENT.....	84
2. INFORMATION ON EQUIPMENT OR PROCESS COSTS, SOURCES OF METHANE EMISSIONS, AND REDUCTION OR CONTROL OPTIONS .....	88
3. IMPLEMENTATION .....	100
4. CHALLENGES AND OPPORTUNITIES TO ACHIEVE METHANE REDUCTION IN NEW MEXICO .....	101
5. COMPRESSORS AND ENGINES- PATH FORWARD .....	102
<b>SECTION 5, INFRASTRUCTURE PLANNING .....</b>	<b>106</b>

Introduction

1. DESCRIPTION OF PROCESS AND EQUIPMENT.....	106
2. INFORMATION ON EQUIPMENT OR PROCESS COSTS, SOURCES OF METHANE EMISSIONS, AND REDUCTION OR CONTROL OPTIONS .....	114
3. IMPLEMENTATION .....	127
4. CHALLENGES AND OPPORTUNITIES TO ACHIEVE METHANE REDUCTION IN NEW MEXICO .....	128
5. INFRASTRUCTURE - PATH FORWARD.....	132
<b>SECTION 6, VENTING/FLARING .....</b>	<b>142</b>
1. DESCRIPTION OF PROCESS AND EQUIPMENT.....	142
2. INFORMATION ON EQUIPMENT OR PROCESS COSTS, SOURCES OF METHANE EMISSIONS, AND REDUCTION OR CONTROL OPTIONS .....	147
3. IMPLEMENTATION .....	182
4. CHALLENGES AND OPPORTUNITIES TO ACHIEVE METHANE REDUCTION IN NEW MEXICO .....	182
5. VENTING AND FLARING - PATH FORWARD.....	188
<b>SECTION 7, WORKOVERS/LIQUIDS UNLOADING .....</b>	<b>198</b>
1. DESCRIPTION OF PROCESS AND EQUIPMENT.....	198
2. INFORMATION ON EQUIPMENT OR PROCESS COSTS, SOURCES OF METHANE EMISSIONS, AND REDUCTION OR CONTROL OPTIONS .....	201
3. IMPLEMENTATION .....	217
4. CHALLENGES AND OPPORTUNITIES TO ACHIEVE METHANE REDUCTION IN NEW MEXICO .....	218
5. WORKOVERS AND LIQUID UNLOADING - PATH FORWARD.....	220
<b>SECTION 8, SEPARATORS / HEATERS / STORAGE VESSELS .....</b>	<b>223</b>
1. DESCRIPTION OF PROCESS AND EQUIPMENT.....	223
2. INFORMATION ON EQUIPMENT OR PROCESS COSTS, SOURCES OF METHANE EMISSIONS, AND REDUCTION OR CONTROL OPTIONS .....	235
3. IMPLEMENTATION .....	252
4. CHALLENGES AND OPPORTUNITIES TO ACHIEVE METHANE REDUCTION IN NEW MEXICO .....	253
5. SEPARATORS - PATH FORWARD .....	254
<b>SECTION 9, COMPLETIONS/ RECOMPLETIONS AND STIMULATIONS .....</b>	<b>260</b>
1. DESCRIPTION OF PROCESS AND EQUIPMENT.....	260
2. INFORMATION ON EQUIPMENT OR PROCESS COSTS, SOURCES OF METHANE EMISSIONS, AND REDUCTION OR CONTROL OPTIONS .....	263
3. IMPLEMENTATION .....	276
4. CHALLENGES AND OPPORTUNITIES TO ACHIEVE METHANE REDUCTION IN NEW MEXICO .....	277
5. COMPLETIONS, RECOMPLETIONS AND STIMULATIONS - PATH FORWARD .....	279

**SECTION 10, CROSS-CUTTING PATH FORWARD REPORT .....287**

- 1. NARRATIVE INTRODUCING THE CROSS- CUTTING PATH FORWARD ..... 287
- 2. CROSS-CUTTING - PATH FORWARD ..... 288

DRAFT

# INTRODUCTION

In Executive Order 2019-03, Governor Michelle Lujan Grisham directed the New Mexico Environment Department (NMED) and Energy, Minerals and Natural Resources Department (EMNRD) to:

*“...jointly develop a statewide, enforceable regulatory framework to secure reductions in oil and gas sector methane emissions and to prevent waste from new and existing sources and enact such rules as soon as practicable.”*

To move forward in a manner grounded in science, innovation, collaboration and compliance, NMED and EMNRD sought nominations for a technical Methane Advisory Panel (MAP). The 27 individual MAP members represented environmental organizations, the interests of the Nations, tribes and pueblos in New Mexico and the oil and gas industry – including small and large independent operators as well as the major, vertically-integrated companies. Industry representatives included companies with interests in the Permian and San Juan Basins that drill, develop, complete and operate oil and natural gas wells and infrastructure. Additional technical expertise was provided by professionals from Los Alamos National Laboratory, Colorado State University and the New Mexico Institute of Mining and Technology. The MAP developed the following draft report, which provides an informational foundation on the technical side of how the oil and gas industry emits methane and what methods can curb methane emissions and prevent waste of this resource. A list of MAP members, presentations and draft technical documents were posted online throughout the process, along with this full draft technical report.

The MAP’s draft technical report is a New Mexico-specific treatise on methane emissions and potential reduction mechanisms. Once final, the Departments will use this report as a resource as they move into formal rulemaking next year. The MAP was tasked with considering a wide range of perspectives, so there is robust discussion of methane issues representing a diversity of technical opinions. The group was not asked to provide recommendations or to reach consensus. Rather, they were asked to provide a full description of processes that could result in methane emissions and waste and to identify multiple methane reduction strategies for NMED and EMNRD to investigate further. Through the lens of their varied individual experiences, the MAP members considered new and innovative technologies, as well as existing and proposed solutions found in other states.

# METHANE ADVISORY PANEL MEMBERS

<u>Member Name</u>	<u>Affiliation</u>
<b>Mario Atencio</b>	Chaco Canyon Coalition
<b>David Baake</b>	Sierra Club
<b>Bruce Baizel</b>	Earthworks
<b>Milind Bhatte</b>	ConocoPhillips
<b>Ryan Davis</b>	Merrion Oil and Gas Corporation
<b>Matt Eales</b>	Lucid Energy Group
<b>Robert Eales</b>	EOG Resources, Inc.
<b>Mike Eisenfeld</b>	San Juan Citizens Alliance
<b>Tim Friesenhahn</b>	Enduring Resources, LLC
<b>Kerry Harpole</b>	Marathon Oil
<b>Matt Henderson</b>	Hilcorp Energy
<b>Donna House</b>	Bio-cultural diversity/Healthy indigenous communities advocate
<b>Ernie Johnson</b>	Whiptail Midstream
<b>Zach LaCount</b>	Mewbourne Oil Company
<b>Scott Lindsay</b>	DJR Energy
<b>John Maxey</b>	Hanson Operating Company Inc.
<b>Dennis Newman</b>	Occidental Petroleum Corporation
<b>Gabe Pacyniak</b>	Center for Civic Policy
<b>Elizabeth Paranhos</b>	Environmental Defense Fund
<b>Karen Pratt</b>	XTO Energy, Inc.
<b>Vanessa Ryan</b>	Chevron Corporation
<b>Charlie de Saillan</b>	New Mexico Environmental Law Center
<b>Jason Sandel</b>	Aztec Well Servicing
<b>Don Schreiber</b>	Rancher/ Environmental advocate
<b>Tom Singer</b>	Western Environmental Law Center
<b>Mike Smith</b>	Devon
<b>Paul Thompson</b>	Epic Energy

## NMED/EMNRD METHANE ADVISORY PANEL

# SECTION 1, PNEUMATIC CONTROLLERS/PUMPS

Discussion for MAP members on September 27, 2019

---

NOTE: The focus of this report is processes, and the associated equipment, directly related to the release or capture of methane gas. We are not requesting information on processes/equipment that are not related to the release or capture of methane gas.

## 1. DESCRIPTION OF PROCESS AND EQUIPMENT

Provide a description of the processes and/or equipment used in oil and/or gas extraction for this topic. Note that this report template will be used for all topics of the MAP review and, thus, not all questions or information may be relevant for each topic. If information is not relevant, indicate N/A. Note any differences expected for differing well types, industry sector, or basin location.

### Technical description of the process or equipment:

Pneumatic controllers are process control devices used throughout the oil and natural gas industry as part of the instrumentation to control the position of valves and may be actuated using pressurized natural gas. Natural gas- powered pneumatic controllers use natural gas as motive force operate valves that regulate safety shut-down, position, fluid level, pressure, temperature and flow rate. Methane emissions occur from natural-gas powered pneumatic controllers when the pressurized gas is directed to atmosphere after the control action is performed.

Pneumatic pumps are used to inject chemicals into the wellbore, to circulate glycol in cold climates/weather and to move liquids from one place to another (sump pumps). From US EPA's Control Technique Guidelines (2016):

<https://www.epa.gov/sites/production/files/2016-10/documents/2016-ctg-oil-and-gas.pdf>

“Chemical injection pumps are positive displacement, reciprocating units designed to inject precise amounts of chemical into a process stream. Positive displacement pumps work by allowing a fluid to

flow into an enclosed cavity from a low-pressure source, trapping the fluid, and then forcing it out into a high-pressure receiver by decreasing the volume of the cavity. A complete reciprocating stroke includes two movements, referred to as an upward motion or suction stroke, and a downward motion or power stroke. During the suction stroke, the chemical is lifted through the suction check valve into the fluid cylinder. The suction check valve is forced open by the suction lift produced by the plunger and the head of the liquid being pumped. Simultaneously, the discharge check valve remains closed, thus allowing the chemical to remain in the fluid chamber. During the power stroke, the plunger assembly is forced downwards, immediately shutting off the suction check valve. Simultaneously, the chemical is displaced, forcing open the discharge check valve and allowing the fluid to be discharged.

Typical chemicals injected in an oil or natural gas field are biocides, demulsifiers, clarifiers, corrosion inhibitors, scale inhibitors, hydrate inhibitors, paraffin dewaxers, surfactants, oxygen scavengers, and H<sub>2</sub>S scavengers. These chemicals are normally injected at the wellhead and into gathering lines or at production separation facilities. Because the injection rates are typically small, the pumps are also small. They are often attached to barrels containing the chemical being injected.

Diaphragm pumps are positive displacement pumps, meaning they use contracting and expanding cavities to move fluids. Diaphragm pumps work by flexing the diaphragm out of the displacement chamber. When the diaphragm moves out, the volume of the pump chamber increases and causes the pressure within the chamber to decrease and draw in fluid. The inward stroke has the opposite effect, decreasing the volume and increasing the pressure of the chamber to move out fluid.”

Methane emissions occur from pneumatic pumps when the pressurized natural gas that is used to drive the pumping action is released to atmosphere after being used for the pumping action. The amount of methane emitted will depend on the type of pump utilized and the concentration of methane in the associated gas stream.

Gas-assisted glycol pumps, are a specific type of pneumatic pump used to circulate the glycol fluid used in glycol dehydrators. The MAP process discussed this type of pump during the dehydrator session and they will not be discussed in this document.

Provide the segment(s) of the industry that the equipment or process is found:

The equipment is found throughout the production, midstream, gas plants and transmission sectors.

Describe how the equipment or process is used:

Pneumatic controllers are used to control multiple processes based on a sensed process parameter. Pneumatic controllers can be used as emergency shut off devices, to regulate flow or liquid levels, as temperature and pressure regulators, etc. An example of the function of a pneumatic controller would be to control liquid level in a separator. When the liquid level in a separator reaches a high set-point in the separator based on the setting of a level gauge, the associated pneumatic controller sends a signal



to open the control valve between the separator and the tank. For an emitting pneumatic controller, this signal would consist of pressurized pneumatic gas to turn the valve from the “closed” to the “open” position. When the level in the separator reaches a low level, the pneumatic controller sends a signal to the control valve to close and to stop flow from the separator to the tank.

Pneumatic pumps range from chemical injection pumps which may inject a few tablespoons of corrosion inhibitor to a wellbore to large diaphragm pumps which move thousands of gallons of product an hour from one tank to another, to pump water out of containment areas after wet weather, or for heat trace to protect pipes from freezing in cold weather.

**Provide the common process configurations that use this equipment or process:**

Pneumatic controllers can be installed in many types of service. The controller is placed at or near the valve to actuate it. The placement of the valve depends on the type of service. The diagram below from the University of Texas demonstrates where a typical controller is placed in a generic process:

<http://dept.ceer.utexas.edu/methane2/study/docs/UT%20Study%20Pneumatics%20FAQ%20to%20SC.pdf>

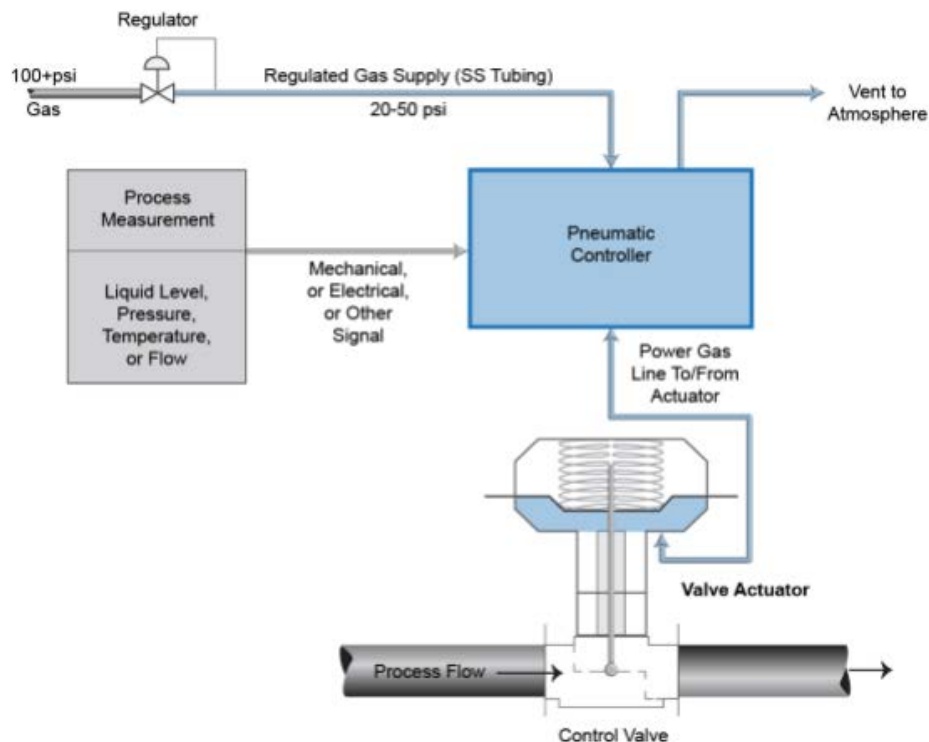

## Pneumatic Piston Pump

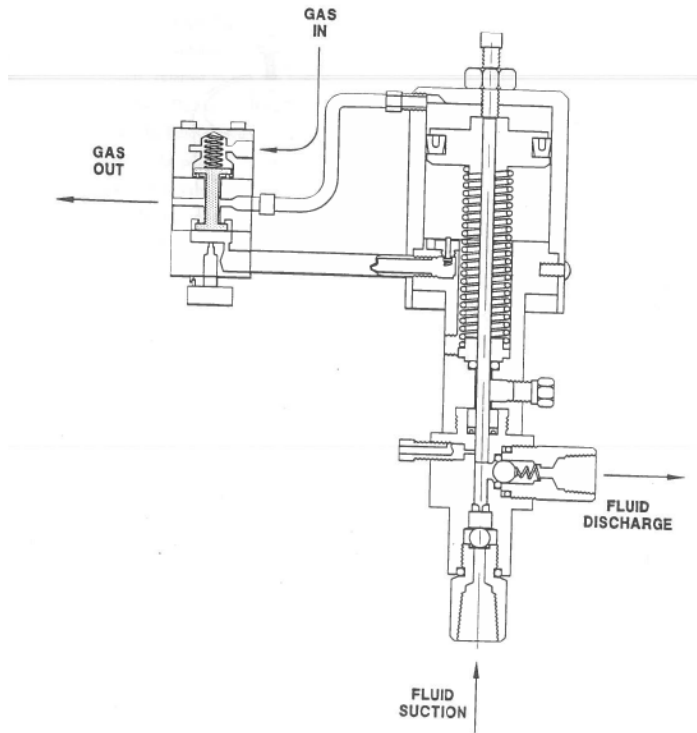

Figure 3-2. Piston Pump Cut-away Schematic

## Pneumatic Diaphragm Pump

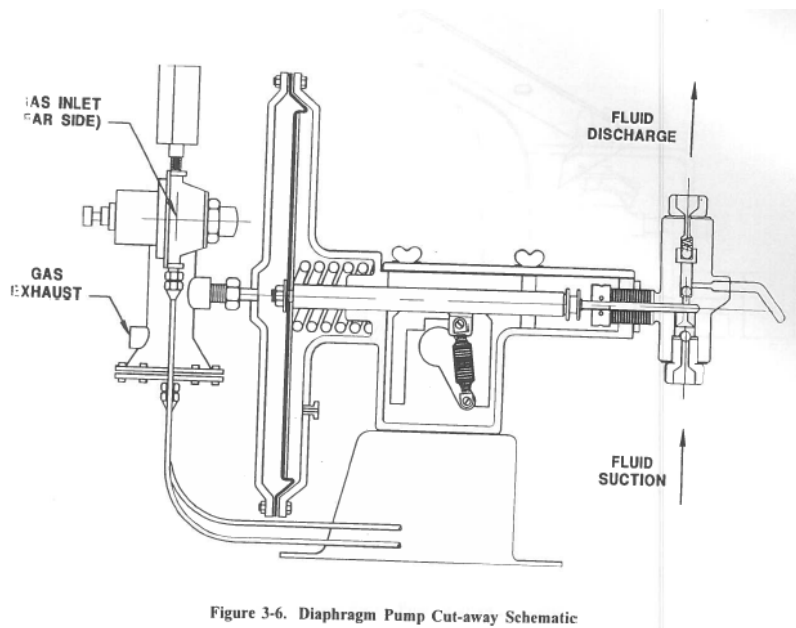

Figure 3-6. Diaphragm Pump Cut-away Schematic

What is the distribution of the equipment or process across business segments?

This equipment is found in upstream, midstream and transmission segments.

How has this equipment or process evolved over time?

The technology remains similar, though there may be greater application of compressed air in new oil well locations where there is electricity. Manufacturers have focused on developing lower bleed devices which industry has been adopting for new facilities.

In recent years, low-powered electric controllers have become available for some pneumatic controller applications, including controllers that can be powered with air-powered systems with battery storage.

Solar-powered electric injection pumps have become options in recent years.

## 2. INFORMATION ON EQUIPMENT OR PROCESS COSTS, SOURCES OF METHANE EMISSIONS, AND REDUCTION OR CONTROL OPTIONS

Identify the capital and operating costs for the equipment or the process. Identify how methane is emitted or could be leaked into the air. Please **prioritize** the list to identify first the largest source of methane from the process or equipment and where there is **potential** for the greatest reduction of methane emissions. Note any differences expected for differing well types, industry sector, or basin location.

## Sources of Methane:

Provide an overview of the sources of methane from this equipment or process:

Natural gas driven pneumatic controllers are a direct source of methane emissions (see diagram in section one). Continuous bleed controllers emit natural gas all the time, while intermittent vent controllers emit natural gas only when actuating if operating properly. In the Control Technique Guidelines, EPA found that continuous low bleed controllers emit between 0.2 scfhr up to 5 scfhr, while high bleeds vent from 7 scfhr to 100 scfhr. (US EPA Control Technique Guidelines 6.2.2.2

<https://www.epa.gov/sites/production/files/2016-10/documents/2016-ctg-oil-and-gas.pdf>)

Analysis of GHGRP data found in the New Mexico Oil and Gas Association's Methane Mitigation Roadmap below: <https://www.nmoga.org/methaneroadmap>

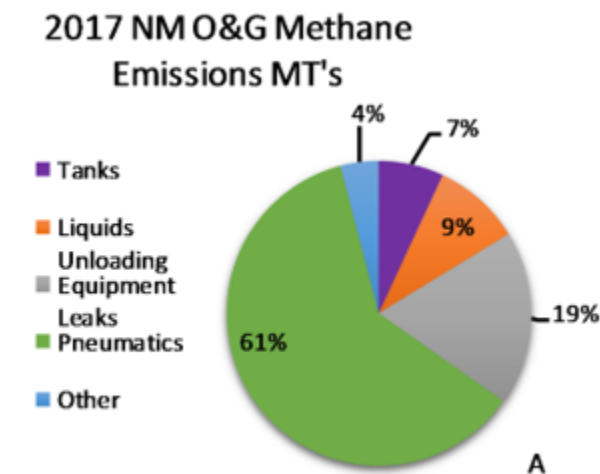

New Wells:

Pneumatic controllers and pumps are used in both new and existing facilities.

Existing Wells:

Pneumatic controllers and pumps are used in both new and existing facilities.

How are the emissions calculated for this equipment or process?

US EPA defines pneumatic controllers in three different categories, each with its own emissions factor in the production and gathering and boosting segments ([link](#)):

- Continuous high bleed: these controllers vent continuously at a rate of over 6 scf/hour per manufacturer specifications. EPA Emissions Factor: 37.3 scf/hr/device

- Continuous low bleed: these controllers vent continuously at a rate of less than 6 scf/hour per manufacturer specifications. EPA Emissions Factor: 1.39 scf/hr/device
- Intermittent: These controllers vent only when actuating. Depending on the type of service or operation the controller is in, it can actuate only a few times a year or multiple times per hour. Current regulatory emission factors do not account for the frequency of actuation or other parameters than may influence emissions and are intended to be an average emission rate over a large population of devices. EPA Emissions Factor: 13.5 scf/hr/device. It is important to note that intermittent vent controllers make up a large majority of the inventory in most basins. Also, some studies conclude that emission factors for intermittent vent controllers are too high. The variability in these factors are dependent on geographical area. Should an alternate emission factor be used to estimate emissions from these devices, the total emissions would be vastly lower than what is reflected in GHGRP.

The latest multi-region emission factor study for pneumatic controllers in the United States ([Allen 2014](#)) does not include sufficient information to develop a basin-specific emission factor for the Permian or San Juan as emission factors were developed based on regions used in EPA GHG Inventory estimation at that time. The study found a national-average emission of 5.5 scf/hr/device. The study-average emission rate in the Midcontinent region, which geographically includes the Permian Basin, was 5.8 scf/hr/device. The study-average emission rate in the Rocky Mountain region, which geographically includes the San Juan Basin, was 0.8 scf/hr/device. It is not possible to discern if any of the regional measurements occurred in the Permian or San Juan basins.

For pneumatic controller emission reporting, US EPA requires that operators provide an actual count of devices that emit natural gas to atmosphere by each of the three categories at the basin (i.e. Permian or San Juan) and segment (i.e. production or gathering and boosting) level in each year. The count of devices, the emission factor, and a gas composition (i.e. percent of methane in the gas) drive the emission calculation for this source. There is no requirement to report or count of other types of pneumatic controllers that do not have associated emissions to atmosphere.

Equation from GHGRP Subpart W: [https://www.ecfr.gov/cgi-bin/text-idx?SID=3393fe39418e975c59618f6249f55516&mc=true&node=se40.23.98\\_1233&rgn=div8](https://www.ecfr.gov/cgi-bin/text-idx?SID=3393fe39418e975c59618f6249f55516&mc=true&node=se40.23.98_1233&rgn=div8)

$$E_{s,i} = \sum_{t=1}^T Count_t * EF_t * GHG_t * T_t \quad (\text{Eq. W-1})$$

Where:

$E_{s,i}$  = Annual total volumetric GHG emissions at standard conditions in standard cubic feet per year from natural gas pneumatic device vents, of types “t” (continuous high bleed, continuous low bleed, intermittent bleed), for GHG<sub>i</sub>.

$Count_t$  = Total number of natural gas pneumatic devices of type “t” (continuous high bleed, continuous low bleed, intermittent bleed) as determined in paragraph (a)(1) or (a)(2) of this section.

$EF_t$  = Population emission factors for natural gas pneumatic device vents (in standard cubic feet per hour per device) of each type “t” listed in Tables W-1A, W-3B, and W-4B to this subpart for onshore petroleum and natural gas production, onshore natural gas transmission compression, and underground natural gas storage facilities, respectively. Onshore petroleum and natural gas gathering and boosting facilities must use the population emission factors listed in Table W-1A to this subpart.

$GHG_i$  = For onshore petroleum and natural gas production facilities, onshore petroleum and natural gas gathering and boosting facilities, onshore natural gas transmission compression facilities, and underground natural gas storage facilities, concentration of  $GHG_i$ ,  $CH_4$  or  $CO_2$ , in produced natural gas or processed natural gas for each facility as specified in paragraphs (u)(2)(i), (iii), and (iv) of this section.

$T_t$  = Average estimated number of hours in the operating year the devices, of each type “t”, were operational using engineering estimates based on best available data. Default is 8,760 hours.

US EPA has a single emission factor for all pneumatic pumps ([link](#)) that is 13.3 scf/hr/pump and are defined as any natural gas-driven pneumatic pump that is not part of a dehydration system since those types of pumps are reported with emissions from dehydrators. As with pneumatic controllers, operators provide a count of pneumatic pumps in operation at the basin-level for each segment. Emissions are then estimated based on the emission factor, the count of pneumatic pumps, and the gas composition.

#### What data is available to quantify emissions/waste for this equipment or process?

The US EPA publishes most of the emission information and activity data that it receives as part of the US GHG Reporting Program annually ([https://ghgdata.epa.gov/ghgp/main.do?site\\_preference=normal#](https://ghgdata.epa.gov/ghgp/main.do?site_preference=normal#)). By March 31<sup>st</sup> of each year, operators upload their emission information to the EPA website for the previous year (i.e. 2018 emission information was reported in March 2019), EPA undertakes a quality assurance process, and uploads the information in October to a publicly accessible website. Care should be taken in estimating emissions from this inventory for New Mexico since both the Permian and San Juan Basins span multiple states and are challenging to separate emissions between states for all source categories. In the analysis below, NM data was separated from surrounding state data. Also, operators with less than 25,000 MT  $CO_2e$  emissions are exempt from reporting emissions to the GHGRP. Therefore, the production segment, all emissions were scaled up to the total well count reported by the New Mexico Oil Conservation Division (NMOCD) (EIA for national). For the G&B segment, there is no information to enable scaling-up GHGRP reported emissions and raw GHGRP reported emission quantities are shown.

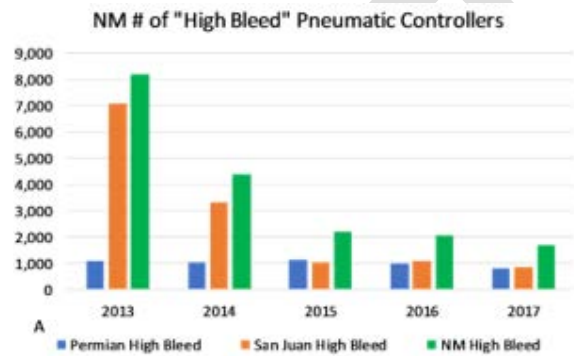
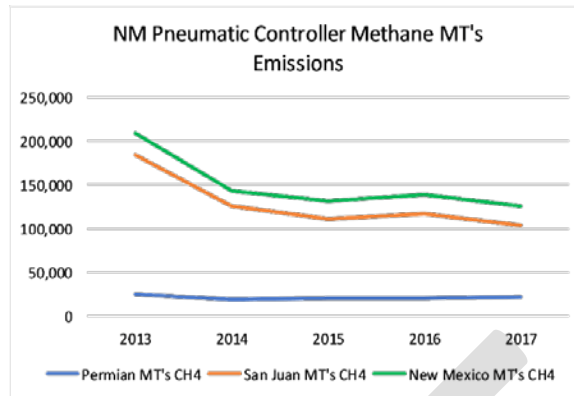

Analysis of GHGRP data found in the New Mexico Oil and Gas Association's Methane Mitigation Roadmap: <https://www.nmoga.org/methaneroadmap>

The large discrepancy in emissions from Permian vs San Juan Basin reflects distinguishing characteristics of the two basins. In gas plays, the per site controller counts are much lower than oil plays, thus, creating a disincentive for the use of more expensive compressed air applications as those installations are uneconomic unless there is a significant number of controllers needed for the process. Also, Permian basin gas also contains less methane by composition in the stream than San Juan Basin gas, therefore, the resulting methane concentration as a variable to calculating emissions result in lower per-controller emissions in the Permian.

**What are the data gaps in quantifying emissions/waste for this equipment?**

Current US EPA emission factors are based on a relatively small sample of pneumatic controller measurements that were conducted in the early 1990's. More recently, several direct measurement studies have been undertaken to try to update the US EPA emission factor by directly measuring emissions from a population of devices as they were encountered in the field. On average, these studies, which are outlined in the table below, have found that aggregate emissions per pneumatic controller measured are lower than those used in the GHGRP. It is recognized that each study

conducted has certain limitations such as equipment reliability and calibration, measurement techniques, duration of sample collection, sample size and representativeness, etc.

There have been a number of studies, some of which find that the EPA emission factors are overestimated in some cases:

Study Name	# PC Samples	Application	Duration of Measurement	Whole gas (avg ER) (scf/hr)
<a href="#">EDF/UTexas 2014</a>	377	Well pads natural gas production, several U.S. basins	15 minutes	5.5
<a href="#">EPA – Thoma Utah Study 2016</a>	80	Unitah Basin well pads, oil and gas production	1 hour or more	0.36
Oklahoma Independent Producers Association	680	Oil and gas production in Oklahoma	NA	1.05 (calc)
<a href="#">Prasino 2013</a>	601	British Columbia oil and gas sites, measured high bleeds only	30 minutes	8.7 – 9.2
<a href="#">Luck et al 2019</a> (Gathering facilities)  (data quality affected by meter problem)	72	US gathering facilities  Due to potential biases associated with flow meter errors, updates to EPA emission factors based on these data are not proposed	76 hours (avg)  Authors found that many of the problems observed would not have been observed using typical measurement durations	Low-bleed: 7.6 High-bleed: 19.3 Intermittent-bleed: 11.1 Overall: 10.9
<a href="#">Cap-On Energy BC Oil and Gas Methane Emissions Field Study</a>  ( <a href="#">Data tables here</a> )		British Columbia wellpads	Direct equip. cts. from 266 pads, with EFs calculated based on counts of specific models and recent measured EFs for each model	Emissions reported by controller function (irrespective of continuous-bleed / intermittent-bleed distinction. See figure below.
Measurement-Based Emissions Factors Using	34	Fugitive emissions including 34	Continuously over 8 months on some	Level Controllers: (Intermittent) 16.92



BHGE Advanced Methane Sensing Technologies and Analytics		pneumatic controllers (18 level controllers, 13 pressure controllers and 2 methanol pumps)	site and 4 months on other sites	Pressure Regulators: (intermittent) 11.94 Methanol Pumps: 42.54
--	--	--	----------------------------------	--

Results from Cap-On study for British Columbia pneumatic controllers (and pumps). The horizontal line (0.17 m<sup>3</sup>/hr) corresponds to 6 scf/hr:

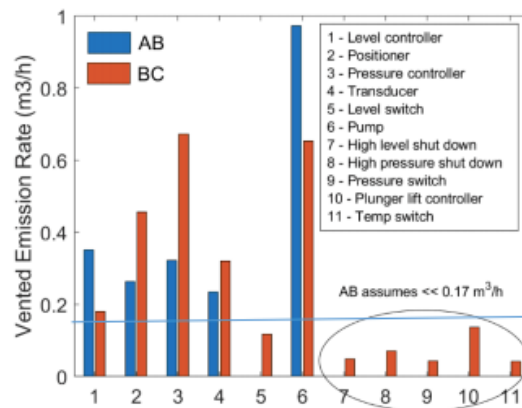

Figure 17: Comparison of vented emissions between this study (red) and Greenpath 2016 study in AB (blue).

From Cap-On BC study. [Cap-On Energy BC Oil and Gas Methane Emissions Field Study](#). Page 53.

Challenges persist in the national extrapolation of emission factors from any single measurement study as different studies have noted regional, company, and service-level emission differences in emissions of pneumatic controllers. Most notably, studies such as EDF/UTexas have found large variation in emission rates for intermittent vent controllers with a small subset of devices (~19%) being responsible for the majority of the device emissions (~95%) and more than 50% of the sampled devices had no recorded emissions over the sample period. Based on analysis of time series data from the study measurements, the team was able to identify that most of the devices with elevated emissions were emitting in a manner that was inconsistent with manufacturer design.

A significant contribution to the uncertainty in emissions from pneumatic controllers is the high incidence of improper operations for pneumatic controllers. These problems have been identified in a number of studies, including the [Ft. Worth AQ Study](#), the Prasino study linked above, and EDF/UTexas 2014. A recent study from Colorado State and U Texas ([Luck et al. 2019](#)) found that 42% of the 72 controllers successfully measured at US gas gathering sites were operating abnormally, with much higher emissions than from devices operating normally. 25 of the 40 (62.5%) intermittent-bleed controllers the researchers examined were operating abnormally, with high average emissions for the devices operating abnormally (about 16

scfh). The researchers also noted that in many cases the high emissions and abnormal operations were only observed because of the long observation time (average was over three days). Note that the precision and accuracy of the emission factors produced by this study was degraded by an instrumental problem described in the paper, but the authors concluded that the qualitative results of the study are robust despite the instrumental problem.

Baker Hughes, a GE Company, (BHGE) has released a report for Environmental and Climate Change Canada (ECCC) and Petroleum Technology Alliance Canada (PTAC) on 7-site (54 component) case study on the performance of a new component-level continuous monitoring technology (LUMEN). Briefly, the LUMEN technology is placed 12-16 inches from a known methane vent point to collect real-time part per million (ppm) methane readings. The methane reading is combined with on-site meteorological data into a model to infer associated emission rates. BHGE does not provide references or supporting information in the report to show the expected accuracy of the method relative to controlled releases. Experience in US-based testing of ambient methane detection technologies has shown that new technologies are often better at detection than emission rate quantification due to the inherent uncertainties in generating near-field dispersion characteristics directly. Components selected for the study were found to have emissions from an on-site screening, and 34 pneumatic controllers (3 dump valves, 18 level controllers, and 13 pressure controllers) were selected for long-term LUMEN deployment. In particular, several high bleeds were selected to show the difference between pre and post retrofits with lower emission technologies. Care should be taken in drawing conclusion between the long-term LUMEN measurements, and other methods of reporting emissions since the comparison to High Flow measurements is based on spot samples (versus time series, as is best practice in emission studies) and to emission factors as the comparison is being made in the report to emission factors from components (like valves) rather than pneumatic devices.

### **Economic Description of the Process or Equipment:**

What is the per unit cost of the equipment or the costs associated with the process?

Costs vary widely based upon type of unit and type of service.

Table 1 of the “Cost-Effectiveness of Comprehensive Oil and Gas Emissions Reduction Rules in New Mexico” lists per unit costs for low-bleed pneumatic controller abatement technology as \$49.30 per mcf of reduced methane (\$2,563.40 per tonne).<sup>1</sup>

---

<sup>1</sup> “Cost-Effectiveness of Comprehensive Oil and Gas Emissions Reduction Rules in New Mexico,” Erin Camp, PhD, Nate Garner, Asa Hopkins, PhD, Synapse Energy Economics, Inc., September 13, 2019, page 9, Table 1, <http://blogs.edf.org/energyexchange/files/2019/09/Synapse-Methane-Cost-Benefit-Report.pdf>.

### What are the annualized operating costs for the equipment or costs associated with the process?

Costs vary widely based upon type of service.

### If the equipment or process is powered, what are the costs?

If electricity is available, some process controls and/or very small pumps may be able to be electrically powered. Air compression may be required. Solar-powered systems to power electric controllers have been demonstrated at production sites. Costs for solar-powered systems vary by facility size / configuration. Tools are available to estimate costs of solar-powered systems for a given site configuration.

Carbon Limits' produced a report with cost information for electric controllers (including solar power) and air-driven systems. <https://www.carbonlimits.no/project/zero-emission-technologies-pneumatic-controllers-in-usa/>

Additionally, Carbon Limits produced an Excel Tool which can be used to calculate costs and emission reductions, using data from their report, for a site with a given configuration (power already available or not, various numbers of controllers and pumps, etc.). This Excel file is provided.

There is not a "one size fits all" tool (such as the Carbon Limits tool) that works on every oil and gas site with pneumatic controllers and pumps. For example, many tools apply tax break scenarios or credits that are assumed to be in the future or credits available today but are scheduled to not be available in the next few years. Oil and gas operators have internal tools to access feasibility, application, emission reductions and cost scenarios that can provide site specific applications.

Much of California has access to electricity in the oil and gas fields which changes feasibility and costs associated with applications of electric or air driven pumps. Colorado regulations have specific scenarios where implementation of the regulations are dependent on electrical availability and/or existing control devices. It is important to consider various conditions of existing location infrastructure on a site by site basis when developing costs for existing sources

### What are the maintenance and repair costs for existing or new equipment?

Costs vary widely based upon type of service and type of unit.

## **Existing Reduction Strategies:**

### How has industry reduced emissions/waste from this equipment or process historically?

There may be greater application of compressed air on new oil well locations with access to electricity. Manufacturers have focused on developing lower bleed devices which industry has been adopting for new facilities. EPA's New Source Performance Standard OOOO (2012) limited the installation of continuous high

bleed controllers in new construction, so over time, controllers are more likely to be low bleed, intermittent or compressed air. There are some services that require high bleed for safety or process purposes.

Existing LDAR quarterly reporting procedures may capture additional emissions reductions from malfunctioning pneumatic controllers with minimal extra cost to operators.<sup>2</sup>

New Wells:

N/A

Existing Wells:

N/A

How have the emission/waste reductions been measured?

Utilizing EPA emissions factors.

How have states and the federal government reduced emissions/waste from this equipment or process historically? In addition, please identify voluntary reductions achieved whether or not they were in response to a regulatory action/requirement.

Federal Regulations

EPA's New Source Performance Standard OOOO (2012) limited the installation of continuous high bleed controllers in new construction, so over time, controllers are more likely to be low bleed, intermittent or compressed air. <https://www.ecfr.gov/cgi-bin/text-idx?node=sp40.7.60.oooo>

NSPS OOOOa requires that natural gas driven diaphragm pump constructed or modified after September 18, 2015 and in use more than 90 days per year must reduce emissions by 95% unless there is not a control device; i.e., a flare or combustion device, or process available onsite. If a device is available but not capable of 95% reduction, operators must still route emissions to the device. If it is technically infeasible to capture and route the gas to a control device (for example if no low-pressure devices are available), operators are not required to meet the control standard. It is important to note that chemical injection pumps are exempt from these requirements.

[https://ecfr.io/Title-40/sp40.8.60.oooo\\_0a](https://ecfr.io/Title-40/sp40.8.60.oooo_0a)

In [43 CFR 3178](#), BLM considers the use of produced gas as a motive force for actuating pneumatic controllers and pumps a beneficial use and, therefore, not waste. However, the original BLM methane

---

<sup>2</sup> "Cost-Effectiveness of Comprehensive Oil and Gas Emissions Reduction Rules in New Mexico," Erin Camp, PhD, Nate Garner, Asa Hopkins, PhD, Synapse Energy Economics, Inc., September 13, 2019, page 9, Table 1, <http://blogs.edf.org/energyexchange/files/2019/09/Synapse-Methane-Cost-Benefit-Report.pdf>.

waste prevention rule did consider such gas a source of waste if the controller emits in excess of 6 scf per hour and required the operator to replace such pneumatic controllers with a controller (including but not limited to a continuous or intermittent pneumatic controller) having a bleed rate of 6 scf per hour or less within established timeframes. It also required the operator to ensure pneumatic controllers are functioning within manufacturers' specifications. For pneumatic diaphragm pumps, the rule required operators to replace all existing pumps with zero emissions pumps, which may be an electric-powered pump; or route the pump exhaust gas to processing equipment for capture and sale. 43 CFR 3179 [link to be identified]

## State Regulations

### Colorado's Regulation 7 Section XVIII

<https://drive.google.com/file/d/168v7vMsFJtS7D8BWInMbaXWA6uZUlyj8/view>

Requires continuous bleed controllers to be replaced or retrofitted to be low bleed unless a high bleed is required for safety or process purposes. New controllers installed after May 2, 2014 use no-bleed where there is on-site electrical grid power and is technically and economically feasible. Controllers at gas processing plants installed after 1/1/2018 must be zero bleed. This is a statewide requirement.

In the ozone nonattainment control area, beginning 1/1/2018, owners or operators of natural gas driven pneumatics must inspect controllers at a frequency aligned with existing leak detection requirements.

California no longer allows installation of continuous-bleed pneumatic controllers (high-bleed or low-bleed). Continuous bleed natural gas-powered pneumatic devices installed prior to January 1, 2016 may be used. Emissions from existing continuous-bleed pneumatic controllers must be measured annually to ensure that the device emits below 6 scfh; any device emitting above 6 scfh must be repaired.

Furthermore, California requires operators to inspect each intermittent-bleed controller during each (quarterly) LDAR inspection to ensure that the device is not emitting gas between actuations. Finally, pneumatic pumps may not vent to atmosphere in California. Note LDAR inspection frequency is summarized above as quarterly but frequency could be annual depending on whether it was subject to an LDAR program at the district level prior to the state rule implementation.

See <https://ww2.arb.ca.gov/sites/default/files/2018-06/2017%20Final%20Reg%20Orders%20GHG%20Emission%20Standards.pdf>, § 95668(e) (pages 18-19)

British Columbia will not allow the installation of pneumatic controllers venting gas to atmosphere at new facilities built after 1/1/21, and will not allow existing pneumatic controllers to vent from large (>4000 HP) compressor stations after 1/1/22, in addition to limiting venting from all remaining controllers (including intermittent-bleed controllers) to 6 scfh (with exceptions for process/safety needs). BC will prohibit venting from new pneumatic pumps installed after 1/1/21 that operate more than 750 hours/year.

See [http://www.bclaws.ca/civix/document/id/regulationbulletin/regulationbulletin/Reg286\\_2018](http://www.bclaws.ca/civix/document/id/regulationbulletin/regulationbulletin/Reg286_2018), pp 6-7.

Alberta requires that 90% of new controllers (at all facilities, new and existing) installed after 1/1/22 not vent to atmosphere. Alberta will also limit emissions from all controllers (intermittent-bleed and continuous-bleed), with the exception of level controllers, to 6 scfh. Level controllers that actuate more than 4x per hour must either “use a relay that has been designed to reduce or minimize transient or dynamic venting or adjust the actuation frequency to ensure that the time between actuations is greater than 15 minutes.” Alberta will prohibit venting from new pneumatic pumps installed after 1/1/22 that operate more than 750 hours/year.

See [https://www.aer.ca/documents/directives/Directive060\\_2020.pdf](https://www.aer.ca/documents/directives/Directive060_2020.pdf), §8.6.1 (pp 77-79).

What are examples of process changes/modifications that reduce or eliminate emissions/waste from this equipment or process?

In some situations, you can route gas from a pump back to a process or control. Feasibility depends on access to low pressure process device in close proximity for the pumps.

As described above, Colorado and California require regular inspection of pneumatic controllers at all sites to ensure that they are not emitting excessively.

As described above, Alberta requires specific actions for level controllers which actuate more than 4x per hour – either reducing actuation frequency, or installing a “relay that has been designed to reduce or minimize transient or dynamic venting.”

**Technology Alternatives:**

List of technology alternatives with link to information or contact information for the company/developers.

Name/Description of Technology	Link (and contact info for company if available)	Availability	Feasibility	Cost Range (choose one)
Replace or retrofit high bleed pneumatic controllers	<a href="https://theenvironmentalpartnership.org/what-were-doing/pneumatic-controllers-upgrades/">https://theenvironmentalpartnership.org/what-were-doing/pneumatic-controllers-upgrades/</a>	<b>In use</b>	High	<b>Low</b>
Replace natural gas with air to actuate	<a href="https://www.epa.gov/sites/production/files/2016-06/documents/ll_instrument_air.pdf">https://www.epa.gov/sites/production/files/2016-06/documents/ll_instrument_air.pdf</a>	<b>In use</b>	Medium – need access to reliable	Medium

pneumatic devices air on newly constructed oil wells	(note older document, cost of controls and price of gas are no longer accurate)  <a href="https://www.carbonlimits.no/project/zero-emission-technologies-pneumatic-controllers-in-usa/">https://www.carbonlimits.no/project/zero-emission-technologies-pneumatic-controllers-in-usa/</a>		grid power and only economic with a very large number of controllers on one site	
Route gas from a pump back to a process or control	<a href="https://www.epa.gov/sites/production/files/2016-10/documents/2016-ctg-oil-and-gas.pdf">https://www.epa.gov/sites/production/files/2016-10/documents/2016-ctg-oil-and-gas.pdf</a>	<b>In use</b>	Low/Medium – need to have a low pressure process device in close proximity to the pump	
Electrical alternatives, including solar powered	<a href="http://www.calscan.net/solutions_ZeroGHGVenting.html">http://www.calscan.net/solutions_ZeroGHGVenting.html</a> (solar-powered package) <a href="https://exlar.com/content/uploads/2014/10/Venting-Solutions.pdf">https://exlar.com/content/uploads/2014/10/Venting-Solutions.pdf</a>  Small air compression solutions: <a href="https://westgentech.com/epod/">https://westgentech.com/epod/</a> <a href="https://lcotechnologies.com/crossfire-compressor.html">https://lcotechnologies.com/crossfire-compressor.html</a>  Electric/Solar Controllers: <a href="https://www.carbonlimits.no/project/zero-emission-technologies-pneumatic-controllers-in-usa/">https://www.carbonlimits.no/project/zero-emission-technologies-pneumatic-controllers-in-usa/</a>	<b>In use</b>	Medium - Solar systems are in use in Canada and therefore should be feasible in NM. Supplier has not verified feasible in NM, power demand may be greater than solar can supply.	<b>Varies with site size / amt of pneumatic equipment.</b>

What technology alternatives exist to reduce or detect emissions? Please list all alternatives identified along with contact information for further investigation of this technology or process.

Replace or retrofit continuous, gas powered high bleed pneumatic controllers.

What are the pros and cons of the alternatives?

Replacement or retrofit of high bleed devices is, in almost all cases, an effective emissions reduction.

For compressed air applications, economic drawbacks and challenges will create barriers for gas plays and smaller scale locations. In gas plays, the per-controller counts are much lower than oil plays, thus, creating a disincentive for the use of more expensive compressed air applications as those installations are uneconomic unless there is a significant number of controllers needed for the process. There are also application limitations as some services require rapid actuation response times; electric (including solar) may not be appropriate for pneumatic operations that require such rapid actuation response times.

With respect to controlling pumps, there are numerous potential safety and operational issues with connecting the discharge from a pneumatic pump to an existing control device and closed vent system. These issues can impact both the performance of the pump and result in back pressure on the other sources being controlled.

Whether considering a VRU, flare, enclosed combustion device, or any other control technique, control devices are designed for a specific set of conditions with a number of key assumptions. For example, a flare header might be designed to allow enough flow to permit two pressure safety valves (PSV) to open simultaneously without creating so much back pressure as to take either PSV out of critical flow. The design is sensitive to other flow streams in the pipe and putting a pump exhaust into that header could result in too much backpressure for the safety devices to function as intended. Conversely, but equally important, a pneumatic pump is chosen for a specific backpressure and the backpressure imposed by a PSV could stop the pump from functioning at a critical moment, exacerbating the already unstable situation that resulted in the opening of the PSVs.

Typically, pneumatics operate on a low-pressure gas stream. If the control device on a site is located a long distance from the pneumatic, the gas emitted from the controller may not make it to the control device, which can cause backpressure on the pneumatic and not allow for operation of the device. In particular, flares are often located at a safe setback distance from operational equipment. At times, control devices, such as flares, may operate at higher pressures than pneumatic devices, which would not allow for routing to the control device.

Additionally, enclosed combustion devices are designed for a maximum BTU load and may not be able to accommodate the exhaust gas from a pneumatic pump affected source without replacing the control device.

The design process for VRUs are even more sensitive to changes than other control devices. The VRU equipment is designed to recover vapors and raise their pressure enough to be useful, is expensive, and has a limited range of possible flow rates. Adding vapor loads to a VRU must be carefully evaluated on a case-by-case basis.



In some instances, an existing control device on a particular site may be owned and operated by a third party, such as a control device owned and operated by a gathering and collection system operator with a glycol dehydration unit on a well site. In these instances, the well site operator does not have the right to route a pneumatic pump affected source exhaust to the control device.

When evaluating use of compressed air on a location one important consideration is the system can introduce water into the pneumatic lines. Instrument air system have a tendency to introduce water into the pneumatic lines. Water can freeze in colder climates damaging the line or the device/pump. Water that makes it way to the device itself could cause the device to not operate or mis-operate. This could result in excess emissions on site.

#### What is needed and available for new wells?

NSPS OOOO already applies to new devices since October 2013. Pumps have been subject to NSPS OOOOa since late 2015.

Zero bleed solutions, including solar-powered, have been demonstrated at wellsites in Canada (noted above).

#### What is needed and available for existing wells?

Continuous high bleed pneumatic devices can be replaced in existing wells. NSPS OOOOa requirements are triggered for pumps that are replaced.

For larger existing wellpads (multiwell), retrofit with zero-bleed technology may be cost-effective.

#### What technology alternatives exist for this equipment or process itself?

In some cases, mechanical valves can be utilized without a pneumatic controller, but there are significant limitations including the control must be in close proximity to the process, can only be used for liquid level, and it may not be sufficient for some processes (like larger process flow or pressure). Retrofit is not feasible.

#### What are the pros and cons of the alternatives?

See above.

### **Costs of Methane Reductions:**

#### What is the cost to achieve methane emission reductions?

The cost of switching from a continuous high bleed controller to a lower emitting option depends on the option chosen, which is dependent on the type of service, and can be dependent on access to electricity. US EPA's control technique guidelines cite an average capital cost per unit as \$2,698.

<https://www.epa.gov/sites/production/files/2016-10/documents/2016-ctg-oil-and-gas.pdf>

### What would be the implementation cost?

#### For new wells?

See above

Costs for compressed air vary depending on the size of the location the presence of reliable grid power, etc. Bringing power to a location for the sole purpose of a compressed air system is not cost effective.

For zero-bleed solutions such as solar-powered electric systems, cost and cost-effectiveness are a function of site size (chiefly, the number of controllers and pumps on site). Larger multi-well pads are more cost-effective for solar systems because of common equipment required for any size site (batteries, control panels, etc.) so costs do not scale with the number of controllers at the low end.

#### For existing wells?

See above

Clean Air Task Force prepared cost estimates of zero-bleed systems for existing wellsites in Colorado, as part of participation in rulemaking hearings in Colorado. Cost estimates were based on data from Carbon Limits' report, linked above. CATF used a tool prepared by Carbon Limits to calculate cost-effectiveness of the use of zero-bleed controllers (electric with solar power, or air-driven) at wellpads with various numbers of wells/controllers. Costs are shown in exhibit A, attached, pages 14-20.

There is not a "one size fits all" tool (such as the Carbon Limits tool) that works on every oil and gas site with pneumatic controllers and pumps. For example, many tools apply tax break scenarios or credits that are assumed to be in the future or credits available today but are scheduled to not be available in the next few years. Oil and gas operators have internal tools to assess feasibility, application, emission reductions and cost scenarios that can provide site specific applications.

Much of California has access to electricity in the oil and gas fields which changes feasibility and costs associated with applications of electric or air driven pumps. Colorado regulations have specific scenarios where implementation of the regulations are dependent on electrical availability and/or existing control devices. It is important to consider various conditions of existing location infrastructure on a site by site basis when developing costs for existing sources.

#### Are there low-cost solutions available?

See above

#### If a solution is high-cost, why is that the case?

Solutions requiring the addition of reliable electricity would be cost prohibitive in most applications. In addition to the cost of bringing power to the site, the cost of electric counterparts to pneumatic devices could be about double the price in some applications.

Solar powered systems add costs to electric systems. Note that operators have reported lower maintenance costs for electric systems compared to field gas-driven pneumatic systems. See <https://www.carbonlimits.no/project/zero-emission-technologies-pneumatic-controllers-in-usa/> These lower costs offset higher equipment costs relative to venting gas-driven pneumatics.

Are there additional technical analyses needed to refine benefits/costs estimates?

N/A

### 3. IMPLEMENTATION

For each piece of equipment or process, please consider the following questions and add other relevant information. If relevant, please identify if the answers are different for large company and small company requirements or are different for well type or basin.

#### **Implementation Feasibility:**

What is the feasibility of implementation (availability of required technology or contractors, potential permitting requirements, potential for innovation)?

With sufficient time for manufacturers to stock parts, it is feasible to replace or retrofit continuous high bleed controllers with a reasonable implementation period. For some replacements or retrofit activities, it is necessary to conduct such work during a turnaround.

For leak detection, intermittent bleed controllers which are part of an existing LDAR program can be surveyed by waiting for the device to be non-actuating before using an optical gas imager or sniffer to see if there are emissions. For continuous bleed controllers, it is very difficult and subjective, to determine if the device is operating as designed or not. Conducting LDAR on a site just to monitor a controller can be very expensive, the variability is primarily driven by the cost of bringing out an operator to a site for an inspection. In 2017, EDF published a study called “The Emerging Methane Detection Industry” which indicates that median one-way travel distance to a site for an LDAR contractor is 50-100 miles. The study notes that 21% of firms interviewed have a typical travel distance of 300-1,000 miles one way to a site.

California also subjects both continuous and intermittent bleed natural gas pneumatic devices to LDAR. 17 C.C.R. § 95668 (e). Colorado subjects natural gas driven pneumatics to LDAR requirements (with stricter requirements for non-attainment areas). 5 CO ADC 1001-9:XVIII.D.

See final MAP Leak Detection and Repair Report.

**FIGURE 7.** Typical One-Way Travel Distance Reported

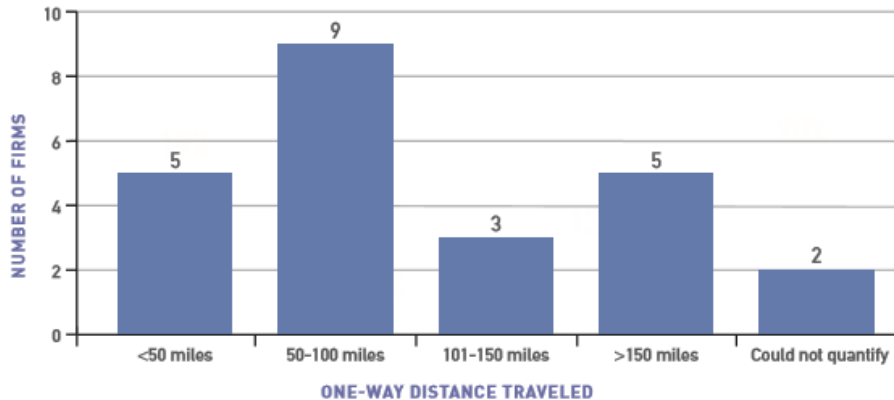

SOURCE: Industry Interviews

NOTE: Based on a sub-sample of 24 LDAR firms

[https://www.dataresearch.com/wp-content/uploads/Methane-Mitigation-Industry-Report\\_Final.pdf](https://www.dataresearch.com/wp-content/uploads/Methane-Mitigation-Industry-Report_Final.pdf)

What is the useful life of equipment?

N/A

What are the maintenance and repair requirements for equipment required for methane reduction?

There is no difference in maintenance and repair between a high and low bleed continuous emitting controller.

How would emissions be detected, reductions verified and reported?

Operators report the number of devices through the GHGRP if they meet the emissions threshold per basin to require reporting.

## 4. CHALLENGES AND OPPORTUNITIES TO ACHIEVE METHANE REDUCTION IN NEW MEXICO

For each piece of equipment or process, please consider the following questions and add other relevant information. If relevant, please identify if the answers are different for large company and small company requirements or are different for well type or basin.

What regulatory gaps exist for this equipment or process? Are there regulatory gaps filled by the proposed implementation?

Gaps filled by proposed continuous high bleed retrofit or replacement.

Where do conflicting priorities exist between NMED, EMNRD, and NMSLO? Are there opportunities for coordination between these agencies?

None

Are there existing regulations related to methane that do not address the intended purpose? Identify any unintended barriers to methane reductions/capture that may hinder proposed processes.

No

Other considerations or comments (e.g. particular design or technological challenges/opportunities, co-benefits, non-air environmental impacts, etc?):

None

DRAFT

## 5. PNEUMATICS PATH FORWARD<sup>3</sup>

	OPTIONS	DESCRIPTION AND LINK TO INFORMATION IF AVAILABLE. PLEASE LIST THE BENEFIT THAT COULD BE ACHIEVED THROUGH THIS OPTION AND ANY DRAWBACKS OR CHALLENGES TO IMPLEMENTATION	EMISSIONS REDUCTIONS ARE EASY TO ACHIEVE AND ARE COST EFFECTIVE  1 = EASY 5 = HARD	REPORTING, MONITORING AND RECORDING OPTIONS, INCLUDING REMOTE DATA COLLECTION	IS THIS OPTION HELPFUL IN THE SAN JUAN BASIN, PERMIAN BASIN OR BOTH
1.1	Replace or retrofit continuous high bleed pneumatic controllers to low bleed	<a href="https://theenvironmentalpartnership.org/what-were-doing/pneumatic-controllers-upgrades/">https://theenvironmentalpartnership.org/what-were-doing/pneumatic-controllers-upgrades/</a>  76% - 97% reduction (sources: <a href="https://www.edf.org/nm-oil-gas/scenarios">https://www.edf.org/nm-oil-gas/scenarios</a> , <a href="https://www.edf.org/sites/default/files/methane_cost_curve_report.pdf">https://www.edf.org/sites/default/files/methane_cost_curve_report.pdf</a> )	1 2 3 4 5  HIGHLY Bleed rate per EPA	GHGRP reporting	San Juan  Permian  <b>Both</b>
<b>COMMENT</b> A. Safety and process needs may warrant high bleed installations. [page 20] B. Cost recovery of about 1 year in the SJB [page 25]			<b>SUGGESTION TO MAKE THIS OPTION MORE WORKABLE:</b>		
1.2	Replace natural gas with air to actuate pneumatic devices on newly constructed oil wells	<a href="https://www.epa.gov/sites/production/files/2016-06/documents/ii_instrument_air.pdf">https://www.epa.gov/sites/production/files/2016-06/documents/ii_instrument_air.pdf</a> (note older document, cost of controls and price of gas are no longer accurate)  Economic drawbacks and challenges will create barriers for gas plays and smaller scale locations  •Low or high bleed to zero bleed, or zero-bleed at new facilities: 100% reduction ( <a href="https://www.edf.org/nm-oil-gas/scenarios">https://www.edf.org/nm-oil-gas/scenarios</a> )	1 2 3 4 5  Depends on site scale, etc. 11.3 scf/hour for intermittent	No Reporting because no emission source.	San Juan  <b>Permian</b>  Both (Access to electricity and multi-well head)

<sup>3</sup> The format of the Path Forward table evolved over the course of the meetings as the group tried to identify the best method for capturing the most useful information. As a result, there is some variation in the table headers from topic to topic in the final consolidated report.

					sites more likely in the Permian.)
	<p>COMMENT</p> <p>A. Adequate, reliable electric service is not always readily available when needed. See electricity-cross cutting issues. [page 19]</p>		<p>SUGGESTION TO MAKE THIS OPTION MORE WORKABLE:</p> <p>B. If electrical infrastructure available and site with sufficient number of pneumatics. [page 22]</p> <p>C. Need to identify equipment that must be operated on speed. [page 24]</p>		
1.3	<p>Replace natural gas driven pneumatics with electric actuators / pumps when direct power (line power) is available.</p>	<p><a href="https://www.carbonlimits.no/project/zero-emission-technologies-pneumatic-controllers-in-usa/">https://www.carbonlimits.no/project/zero-emission-technologies-pneumatic-controllers-in-usa/</a></p>	<p>1 2 3 4 5</p> <p>Depends on site scale, etc.</p> <p>Cost spreadsheet (as function of site size, etc.) available from CATF</p>		<p>San Juan</p> <p>Permian</p> <p><b>Both</b></p>
	<p>COMMENT</p> <p>A. Use is application specific-not general. [page 24] Actuation response of electric actuators may be inadequate for certain controllers. Introduction of electric actuation can result in reliability/control issues due to additional mechanical complexity. [Devices too slow in some cases.] [page 24]</p> <p>B. Many cases may be general and it is possible to identify exceptions. [page 24]</p>		<p>SUGGESTION TO MAKE THIS OPTION MORE WORKABLE:</p>		
1.4	<p>Replace natural gas driven pneumatics with electric actuators / pumps, using</p>	<p><a href="https://www.carbonlimits.no/project/zero-emission-technologies-pneumatic-controllers-in-usa/">https://www.carbonlimits.no/project/zero-emission-technologies-pneumatic-controllers-in-usa/</a></p>	<p>1 2 3 4 5</p> <p>Depends on site scale, etc.</p>		<p>San Juan</p> <p>Permian</p> <p><b>Both</b></p>

	solar or on-site generation when grid power is not on-site	Cost spreadsheet (as function of site size, etc.) available from CATF			
<p>COMMENT</p> <p>A. The economics being run could not just be for solar power. It would need to include some sort of back-up power source (battery, etc.) to allow for controllers to function at night and during less sunny periods. [page 19]</p> <p>B. Solar power (unless for running an air compressor) would force the use of electric controllers, which are not as common as pneumatic controllers in oil and gas applications. [page 11]</p> <p>C. Actuation response may not be adequate in certain applications. [page 24]</p> <p>D. Insufficient solar/battery capacity can result in inadequate action and/or additional shutdowns which may result in flaring. [page 26]</p> <p>E. Acreage requirements prohibitive [for solar]. Also cost prohibitive to obtain adequate motive force using solar. [page 26]</p> <p>F. Be sure there is consideration of the whole volume of emissions – gas driven generation vs 2 pneumatic valves.</p>		<p>SUGGESTION TO MAKE THIS OPTION MORE WORKABLE:</p> <p>Workability of suggestion is application specific</p>			
1.5	Where technically feasible and considering safety and backpressure issues, route gas from a diaphragm	<a href="https://www.epa.gov/sites/production/files/2016-10/documents/2016-ctg-oil-and-gas.pdf">https://www.epa.gov/sites/production/files/2016-10/documents/2016-ctg-oil-and-gas.pdf</a>	<p>1 2 3 4 5</p> <p>LOW</p>	GHGRP, OOOOa reports	San Juan Permian <b>Both</b>



	pump back to a process.				
	COMMENT A. This is only feasible if there is a low-pressure device in close proximity to the pump. Otherwise there is not enough pressure. [page 20]  B. Limited applicability (b/c of number of diaphragm pump.) Requires low pressure process device to take the gas in close proximity to the pump. [page 22]  C. Maybe used at a large site. [page 25]		SUGGESTION TO MAKE THIS OPTION MORE WORKABLE:		
1.6	LDAR on intermittent bleed pneumatics when not actuating	Quarterly LDAR for malfunctioning: 68% reduction (Source: <a href="https://www.edf.org/nm-oil-gas/scenarios">https://www.edf.org/nm-oil-gas/scenarios</a> )	1 2 3 4 5 HIGH If part of an existing LDAR program.		San Juan  Permian  <b>Both</b>
	COMMENT A. If there is an existing LDAR program. Would add an additional 15 minutes if already conducting LDAR inspection. [page 27]  B. Not a binary decision – see citation for CO rule and how pneumatics are treated differently. [page 22]		SUGGESTION TO MAKE THIS OPTION MORE WORKABLE:		

# SECTION 2, LEAK DETECTION AND REPAIR

Discussion for MAP members on November 7 and 8, 2019

---

NOTE: The focus of this report is processes, and the associated equipment, directly related to the release or capture of methane gas. We are not requesting information on processes/equipment that are not related to the release or capture of methane gas.

## 1. DESCRIPTION OF PROCESS AND EQUIPMENT

Provide a description of the processes and/or equipment used in oil and/or gas extraction for this topic. Note that this report template will be used for all topics of the MAP review and, thus, not all questions or information may be relevant for each topic. If information is not relevant, indicate N/A. Note any differences expected for differing well types, industry sector, or basin location.

### Technical description of the process or equipment:

Oil and gas production facilities contain numerous equipment components such as connectors, covers, closed vent systems (CVS's), flanges, instruments, meters, open ended lines (OEL's), pressure relief devices (PRD's), thief hatches, valves and others (see list from EPA 4/12/2018 Memo: Equivalency of State Fugitive Emissions Programs...). These components are manufactured and installed in ways intended to contain gases or liquids. Although these equipment components are designed to be gas tight, over time leaks can occur. The leaks (emissions) from these components are called fugitive emissions<sup>4</sup>. Fugitive emissions do not include equipment that is designed to vent or release emissions as part of normal operations or equipment that is already subject to monthly AVO inspections under NSPS 60.5411a or 60.5395a (see OOOOa definition of Fugitive Emission Component). Fugitive emissions result from changes in pressure, temperature or mechanical stresses or when seals and gaskets are not fitted or deteriorate over time.

The largest sources of fugitive emissions are generally detected quickly without advanced detection tools. These events are usually detected by observable changes by operators conducting routine inspections using sight, sound or smell (specifically in older facilities, and in operating parameters (i.e. Supervisory Control and Data Acquisition (SCADA) system detection when available, change in sales volume at the meter, compressor shut down).

Leak detection and repair (LDAR) programs employ specialized detection equipment to detect fugitive emissions, which also sometimes include audio, visual, and olfactory observations, generally target sources of fugitive emissions. The most commonly used leak detection equipment is an optical gas imager, but in some areas like parts of California, companies

---

<sup>4</sup> Where devices are designed to vent as part of normal operations, such as natural gas-driven pneumatic devices or uncontrolled storage vessels, the natural gas and associated VOC emissions are not considered a fugitive emission. These emissions are covered in other MAP papers.

also use handheld “sniffers” (portable hydrocarbon detectors) and Tunable Diode Laser Absorption Spectroscopy devices. The detection technology space has received significant investment over the past several years, including the U.S. Department of Energy’s MONITOR program<sup>5</sup>. The results of this investment are just beginning deployment and are beginning to approach commercial scale for some technologies.

In 1990, the Clean Air Act was enacted to address several subject matters including volatile organic compounds (VOCs). This action included the implementation of a Leak Detection and Repair (LDAR) Program to use portable instrumentation and processes to locate emission leaks on process equipment that includes, but is not limited to, things such as compressors, flanges, and valves. If leaks are discovered, they are scheduled for repair.

Traditional technology leak detection technologies allowed by Method 21 include: gas sniffers such as Toxic Vapor Analyzers, organic vapor analyzers, and flame ionization detectors (FID). Moreover, the traditional Method 21 protocol also allows the use of soap bubbles for leak detection which can be very sensitive for small leaks but is not appropriate for hot surfaces. With the introduction of handheld optical gas imaging (OGI) in 2005, the EPA was urged to enact “smart LDAR.” Thus, the EPA’s Alternative Work Practice (AWP) was enacted to allow OGI in lieu of the “sniffer” method in December 2008. In June 2016, the EPA published an amendment to the NSPS regulations that recognized OGI as the Best System for Emissions Reduction (BSER). Traditional Method 21 is now an alternative to OGI with conditions.

Provide the segment(s) of the industry that the equipment or process is found:

Components that have potential to leak can be found throughout the production, midstream, gas plants, transmission and distribution sectors.

Describe how the equipment or process is used:

Components serve numerous purposes throughout the value chain. They are all intended to contain gas, but may develop leaks.

Provide the common process configurations that use this equipment or process

N/A

What is the distribution of the equipment or process across business segments?

This equipment is found in upstream, midstream, transmission and distribution segments.

How has this equipment or process evolved over time?

Over time, awareness of the potential for leaks has grown, so has the number of technology solutions available to detect leaks. Over time, operators minimize threaded connections, receive specific training, conduct preventive maintenance and utilize tools such as SCADA to monitor for changes in process parameters which may indicate a leak.

Federal regulations first specifically addressed oil and natural gas related emissions with the implementation of the Method 21 Alternative Work Practices (AWP) in 2008 and later with the NSPS 2012 OOOO and 2016 OOOOa regulations. Though traditional Method 21 sampling methodologies have been in existence for years, the LDAR components of these most recent regulations were aided by the introduction of OGI and various vent gas recovery infrastructure and procedures.

<sup>5</sup> <https://arpa-e.energy.gov/?q=arpa-e-programs/monitor>

## 2. INFORMATION ON EQUIPMENT OR PROCESS COSTS, SOURCES OF METHANE EMISSIONS, AND REDUCTION OR CONTROL OPTIONS

Identify the capital and operating costs for the equipment or the process. Identify how methane is emitted or could be leaked into the air. Please **prioritize** the list to identify first the largest source of methane from the process or equipment and where there is **potential** for the greatest reduction of methane emissions. Note any differences expected for differing well types, industry sector, or basin location.

### Sources of Methane:

Provide an overview of the sources of methane from this equipment or process:

Leaks, or fugitive emissions, can develop in a range of equipment that is widely deployed across the value chain. Connectors, valves, seals, tubing, open ended lines, and flanges, while designed to contain gas, can develop leaks over time.

Analysis of GHGRP data found in the New Mexico Oil and Gas Association's Methane Mitigation Roadmap below:

<https://www.nmoga.org/methaneroadmap>

2017 NM O&G Methane Emissions MT's

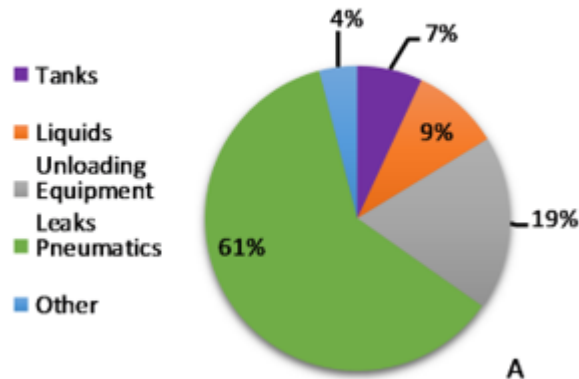

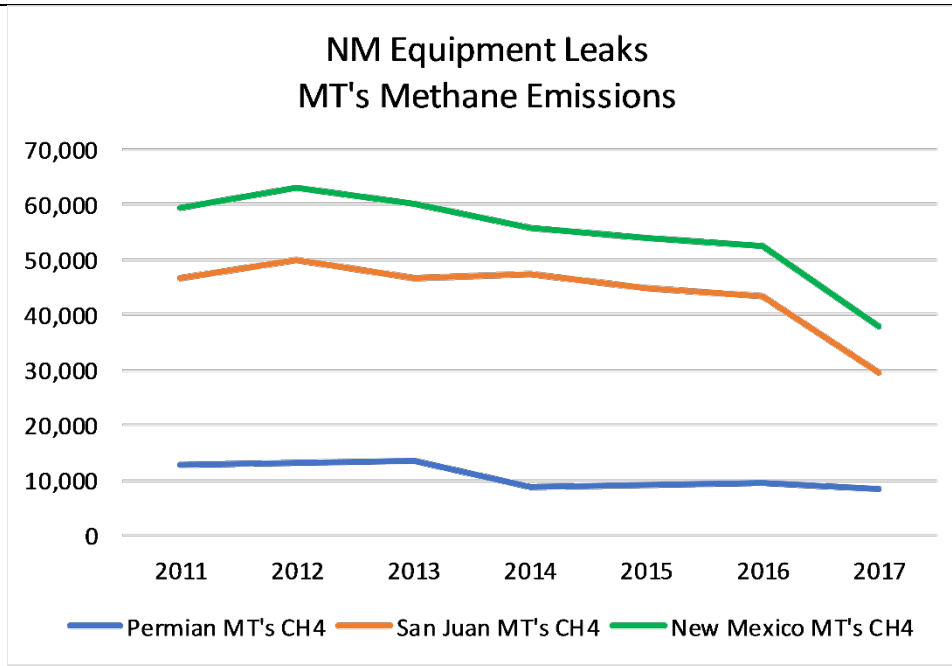

NM equipment leak methane emissions

Leaking components, and equipment as well as improperly operating or malfunctioning equipment, contribute leaks that can be addressed by frequent inspections. The following summarizes studies identifying leaks from a variety of oil and gas sources.

**I. Field Studies Using Direct Measurement Demonstrate the Need for Frequent Instrument-Based Inspections: Significant Emissions May Emanate From Individual Components and Operations**

The scientific consensus, based on numerous studies involving direct measurement of oil and gas leaks, demonstrates the heterogeneous, unpredictable, and ever-shifting nature of equipment leaks. These characteristics strongly point toward the need for frequent, *if not continuous*, inspections to identify and repair leaking components and equipment. Specifically:

- Leaks are Heterogeneously Distributed.** There is considerable evidence that emissions from equipment leaks are heterogeneously distributed—with a small percentage of sources accounting for a large portion of emissions.<sup>6</sup> The concentration of emissions within a relatively small proportion of sources has been observed both among groups

<sup>6</sup> See, e.g., Allen, D.T., et al., “Measurements of methane emissions at natural gas production sites in the United States,” *Proc. Natl. Acad.*, 110 (44) pp. 17768–17773 (“Allen (2013)”), available at <http://www.pnas.org/content/110/44/17768.full>; ERG and Sage Environmental Consulting, LP, “City of Fort Worth Natural Gas Air Quality Study, Final Report” (“Fort Worth Study”) (July 13, 2011), available at <http://fortworthtexas.gov/gaswells/default.aspx?id=87074> (finding that the highest 20 percent of emitting sites account for 60–80 percent of total emissions from all sites; the lowest 50 percent of sites account for only 3–10 percent of total emissions); Zavala-Araiza, et al., (2015) “Toward a Functional Definition of Methane Super-Emitters: Application to Natural Gas Production Sites,” *Environ. Sci. Technol.*, 49, at 8167–8174 (“Zavala-Araiza (2015)”), available at <http://pubs.acs.org/doi/pdfplus/10.1021/acs.est.5b00133> (finding that “functional super-emitter” sites represented approximately 15% of sites within each of several different “cohorts” based on production, but accounted for approximately 58 to 80% of emissions within each production cohort); Zavala-Araiza et al., (2015) “Reconciling divergent estimates of oil and gas methane emissions,” *Proceedings of the National Academy of Sciences*, vol. 112, no. 51, 15597 at 15600 (finding that “at any one time, 2% of facilities in the Barnett region are responsible for 90% of emissions, and 10% are responsible for 90% of emissions.”) (“Barnett Synthesis”).

of components within a site and among groups of entire facilities.<sup>7</sup> One study in particular found that a small number of sources are responsible for a disproportionate amount of emissions, noting specifically that “sites with high proportional loss rates have excess emissions resulting from abnormal or otherwise avoidable operating conditions, such as improperly functioning equipment.”<sup>8</sup>

- **Super-Emitters Are Not Included in Inventories.** Existing inventories do not accurately reflect the presence of disproportionately high emissions or “super-emitters.”<sup>9</sup> A recent series of studies in the Barnett Shale region in Texas (the “Barnett Coordinated Campaign”)—incorporating both top-down and bottom-up measurement—found that emissions were 50 percent greater than estimates based on the GHGI.<sup>10</sup> This study confirms the findings of various prior studies.

The first of these studies, conducted by an independent team of scientists at the University of Texas, found that emissions from equipment leaks, pneumatic controllers and chemical injection pumps were each 38%, 63% and 100% higher, respectively, than as estimated in national inventories.<sup>11</sup> This study also found that 5% of the facilities were responsible for 27% of the emissions.<sup>12</sup>

Two follow-up studies focused specifically on emissions from pneumatic controllers and liquids unloading activities at wells found similar results.<sup>13</sup> Specifically, the studies found that 19 percent of the pneumatic devices accounted for 95 percent of the emissions from the devices tested, and about 20 percent of the wells with unloading emissions accounted for 65 to 83 percent of those emissions. The average methane emissions per pneumatic controller were 17 percent higher than the average emissions per pneumatic controller in EPA’s national greenhouse gas inventory.<sup>14</sup>

These findings were reiterated again in a series of direct measurement studies focusing on emissions from compressor stations in the gathering and processing segment and in the transmission and storage segment. The gathering and processing study found substantial venting from liquids storage tanks at approximately 20 percent of the sampled gathering facilities.<sup>15</sup> Emission rates at these facilities were on average four times higher than rates observed at other facilities and, at some of these sites with substantial emissions, the authors found that company representatives made adjustments resulting in immediate reductions in emissions. In the study on transmission and storage emissions, the two sites with very significant emissions were both due to leaks or venting at isolation

<sup>7</sup> See EPA, “Oil and Natural Gas Sector Leaks: Report for Oil and Natural Gas Sector Leaks” (2014), available at <http://www3.epa.gov/airquality/oilandgas/2014papers/20140415leaks.pdf>.

<sup>8</sup> Zavala-Araiza (2015), supra note 1, at 8167–8174.

<sup>9</sup> Barnett Synthesis, supra note 1, at 15599

<sup>10</sup> Harriss, et al., (2015) “Using Multi-Scale Measurements to Improve Methane Emissions Estimates from Oil and Gas Operations in the Barnett Shale, Texas: Campaign Summary,” *Environ. Sci. Technol.*, **49**, (“Harriss (2015)”), available at <http://pubs.acs.org/doi/abs/10.1021/acs.est.5b02305><http://pubs.acs.org/doi/abs/10.1021/acs.est.5b02305><http://pubs.acs.org/doi/abs/10.1021/acs.est.5b02305> (providing a summary of the 12 studies that were part of the coordinated campaign).

<sup>11</sup> Allen (2013), supra note 1, at 110.

<sup>12</sup> See Allen, D.T., et al, (2015), “Methane Emissions from Process Equipment at Natural Gas Production Sites in the United States: Pneumatic Controllers,” *Environ. Sci. Technol.*, 2015, 49 (1), pp. 633–640 (referencing 2013 Allen study), (“Allen (2015)”), available at <http://pubs.acs.org/doi/abs/10.1021/es5040156> (Allen 2014).

<sup>13</sup> Allen, D.T. et al., “Methane Emissions from Process Equipment at Natural Gas Production Sites in the United States: Liquid Unloadings,” *Environ. Sci. Technol.*, 2015, 49 (1), pp 641–648, available at <http://pubs.acs.org/doi/abs/10.1021/es504016r>.

<sup>14</sup> Allen (2015), supra note 7, pp 633–640.

<sup>15</sup> Mitchell, A.L., et al, (2015) “Measurements of Methane Emissions from Natural Gas Gathering Facilities and Processing Plants,” *Environ. Sci. Technol.*, 2015, 49 (5), pp 3219–3227, available at <http://pubs.acs.org/doi/abs/10.1021/es5052809>.

valves.<sup>16</sup> The study also found that leaks were a major source of emissions across sources, concluding that measured emissions are larger than would be estimated by the emission factors used in EPA's reporting program.

- **Equipment Leaks are Unpredictable.** Recent studies have assessed whether well characteristics and configurations can predict super-emitters, concluding that they are only weakly related,<sup>17</sup> and that these emissions are largely stochastic. A recent helicopter study of 8,220 well pads in seven basins confirms that leaks occur randomly and are not well correlated with characteristics of well pads, such as age, production type or well count.<sup>18</sup> That study focused only on very high emitting sources, given the helicopter survey detection limit which ranged from 35–105 metric tons per year of methane. The paper reported that emissions exceeding the high detection limits were found at 327 sites. 92 percent of the emission sources identified were associated with tanks, including some tanks with control devices that were not functioning properly and so could be expected to be addressed through a leak detection and repair program. While the study did not characterize the individually smaller but collectively significant leaks that fell below the detection limit, it nonetheless confirms that high-emitting leaks occur at a significant number of production sites and that total emissions from such leaks are very likely underestimated in official inventories.
- **Super-Emitters Shift in Time and Space.** Abnormal operating conditions, such as improperly functioning equipment, can occur at different points in time across facilities.<sup>19</sup> While it is true that at any one time roughly 90% of emissions come from 10% of sites, these sites shift over time and space—meaning that, at a future time, a different 10% of sources could be responsible for the majority of emissions.<sup>20</sup>

Other studies resulted in similar findings. In a 2013 study measuring emissions from 200 well pads in the Barnett Shale researchers found that approximately 20% of the well pads were responsible for 80% of the emissions detected.<sup>21</sup> Another study focusing on short-term and maintenance-related emissions at well pads in Texas, Wyoming and Colorado found “a weak correlation between emission and production rates.”<sup>22</sup> This multi-state study suggests that maintenance-related stochastic variables and the ways in which facilities and control equipment are designed can be important factors affecting emissions. (NOTE: to be determined if this is a modeling or measurement study.)

<sup>16</sup> R. Subramanian, et al, (2015) “Methane Emissions from Natural Gas Compressor Stations in the Transmission and Storage Sector: Measurements and Comparisons with the EPA Greenhouse Gas Reporting Program Protocol,” *Environ. Sci. Technol.*, available at <http://pubs.acs.org/doi/abs/10.1021/es5060258>.

<sup>17</sup> Lyon, et al., (2015), “Constructing a Spatially Resolved Methane Emission Inventory for the Barnett Shale Region,” *Environ. Sci. Technol.*, 49, at 8147-57, available at <http://pubs.acs.org/doi/pdf/10.1021/es506359c>; See also Brantley, H.L., et. al., “Assessment of methane emissions from oil and gas production pads using mobile measurements,” *Environmental Science & Technology*, 48(24), pp.14508-14515, available at <http://pubs.acs.org/doi/abs/10.1021/es503070q> (assessing where well characteristics can predict emissions, concluding that they are weakly related and that emissions are largely stochastic); Zavala-Araiza (2015) (“large number of facilities in the Barnett region cause high emitters to always be present, and these high-emitters seem to be spatially and temporally dynamic. . . .To reduce those emissions requires operators to quickly find and fix problems that are always present at the basin scale but that appear to occur at only a subset of sites at any one time, and move from place to place over time.”).

<sup>18</sup> Lyon, et al., “Aerial Surveys of Elevated Hydrocarbon Emissions from Oil and Gas Production Sites,” *Environ. Sci. Technol.*, 2016, 50 (9), pp 4877–4886, available at <http://pubs.acs.org/doi/abs/10.1021/acs.est.6b00705>.

<sup>19</sup> Barnett Synthesis, *supra* note 1 at 15600.

<sup>20</sup> *Id.*

<sup>21</sup> Rella, Chris W., et al, (2015), “Measuring Emissions from Oil and Natural Gas Well Pads Using the Mobile Flux Plane Technique,” *Environ. Sci. Technol.*, 2015, 49 (7), available at <http://pubs.acs.org/doi/abs/10.1021/acs.est.5b00099>.

<sup>22</sup> Brantley, *supra* note 12, at 48.

A recent synthesis of the U.S. studies conducted over the past six years concluded that U.S. production emissions are 60% higher than inventories suggest.<sup>23</sup> Data for this study included measurement of emissions from over 400 individual well pads in six different US basins, validated against “top-down” airborne measurements of emissions from nine oil and gas producing basins. The authors of this synthesis study, as well as the underlying studies analyzed in the synthesis paper, include academics from twenty-five different research institutions. These scientists have concluded that the substantial extra emissions observed in these studies, compared to official inventories, likely arise from improper and abnormal operating conditions at the site level that are best addressed by frequent, if not continuous, inspections.

The nature of these events, specifically that they are unforeseen and unpredictable, require that operators vigilantly inspect their equipment and operations for leaks. Frequent inspections using modern leak detection equipment is one of the most effective way to minimize the pollution associated with these stochastic events.

The table and summary below, taken from the 2018 Omara et al study (link also below) shows the kg/hr of various studies in various basins. When compared to the EDF report referenced above there appears to be some information that stands out. In the recent report EDF says the following about the kg/hr emissions rates, the weighted average is about 14. The Omara study had an average of 1.79 kg/hr.

Major O&NG Basin (EIA sedimentary basin boundary)	Basin-level activity				Basin-level CH4 emissions					CH4 distribution				
	Total # well pad sites	# Wells /Pad	CH4 fraction in NG	CH4 fraction in NG reference	Basin-level CH4 prod (kg/h)	Mean Basin-level CH4 (kg/h)	Basin-level CH4, Lower bound (kg/h)	Basin-level CH4, Upper bound (kg/h)	CH4 kg/h/site	Basin-level mean production normalized CH4 emissions (%)	% of mean total CH4 contributed by <10 Mcfd sites	% of mean total CH4 contributed by 10 to 100 Mcfd sites	% of mean total CH4 contributed by 100 to 1,000 Mcfd sites	% of mean total CH4 contributed by >1,000 Mcfd sites
Appalachian	150,000	1.13	0.83	O&G estimation tool	15,500,000	140,000	95,000	180,000	0.91	0.9%	37%	36%	2.9%	23%
Permian	59,000	1.05	0.79	O&G estimation tool	4,360,000	110,000	67,000	150,000	1.80	2.5%	9.7%	58%	24%	7.8%
Western Gulf	33,000	1.12	0.88	O&G estimation tool	7,860,000	82,000	51,000	130,000	2.50	1.0%	4.8%	38%	37%	22%
TX-LA-MS-Salt	40,000	1.10	0.88	O&G estimation tool	6,460,000	79,000	50,000	110,000	2.00	1.2%	5.4%	43%	38%	13%
Anadarko	25,000	1.08	0.91	O&G estimation tool	3,460,000	59,000	39,000	91,000	2.30	1.7%	4.0%	51%	36%	9.5%
Fort Worth	20,000	1.40	0.88	O&G estimation tool	3,360,000	47,000	28,000	71,000	2.40	1.4%	7.1%	34%	43%	17%
Arkoma	13,000	1.31	0.94	O&G estimation tool	3,090,000	33,000	23,000	55,000	2.50	1.1%	4.7%	42%	36%	15%
Denver	20,000	1.35	0.82	O&G estimation tool	1,330,000	37,000	24,000	49,000	1.90	2.8%	12%	68%	11%	9.6%
San Juan	16,000	1.06	0.83	O&G estimation tool	681,000	31,000	20,000	41,000	2.00	4.5%	3.7%	77%	16%	1.4%
Uinta-Piceance	12,000	2.08	0.81	O&G estimation tool	1,950,000	29,000	17,000	40,000	2.40	1.5%	4.0%	48%	34%	15%
Greater Green River	8,800	1.59	0.78	O&G estimation tool	2,850,000	25,000	14,000	34,000	2.90	0.9%	0.9%	31%	44%	25%
Williston	11,000	1.45	0.51	Brandt et al. <sup>23</sup>	1,020,000	22,000	9,900	24,000	2.00	2.2%	3.3%	55%	30%	14%
San Joaquin	16,000	1.50	0.83	O&G estimation tool	312,000	15,000	10,000	21,000	0.94	4.8%	26%	54%	19%	0.9%
Cherokee Platform	7,000	1.14	0.88	O&G estimation tool	182,000	8,700	6,100	12,000	1.30	4.8%	23%	61%	15%	2.0%
Powder River	3,400	1.09	0.85	O&G estimation tool	292,000	4,900	3,400	7,600	1.40	1.7%	21%	49%	20%	8.8%
Michigan	2,500	1.00	0.83	O&G estimation tool	193,000	5,400	3,500	8,100	2.20	2.8%	4.9%	59%	33%	4.5%
Ardmore	2,100	1.38	0.83	O&G estimation tool	236,000	4,300	2,400	5,600	2.00	1.8%	10%	47%	33%	11%
Other Basin	56,000	1.11	0.84	O&G estimation tool	2,330,000	100,000	69,000	140,000	1.80	4.4%	9.3%	77%	14%	2.7%
US Total	498,000	1.16			55,466,000	830,000	530,000	1,170,000	1.67	1.50%	12%	51%	24%	13%

For the 42 complex sites, there was a good log-normal fit; bootstrapping from the log-normal function resulted in a mean and 95% confidence interval EF of 18.2 (5.2 - 79) kg CH4 site-1 h-1. Human classification of satellite imagery outsourced with Amazon Mechanical Turk estimated that 33% of Permian well pad sites were complex with a slight dependence of percentage of complex sites on gas production. The 15th percentile lower bound EF of 9.2 kg CH4 h-1 was applied to ~8,600 complex sites; the 0.04 kg CH4 h-1 detection limit was applied to the ~17,200 simple sites. (LINK: <https://pubs.acs.org/doi/10.1021/acs.est.8b03535>)

<sup>23</sup> Alvarez, et al., “Assessment of methane emissions from the U.S. oil and gas supply chain” Science, June 2018, <http://science.sciencemag.org/content/early/2018/06/20/science.aar7204.full>.



I also think this table is interesting. In 7 months, EDF went from saying GHGRP is 3.5 times too low to 5 times too low.

<b>EDF Study or Report Title</b>	<b>Primary Study Author</b>	<b>Compared to GHGRP</b>	<b>Methane (metric tons)</b>
EDF Report	EDF - April 11, 2019	5 times too low	1,000,000
Methane emissions from natural gas production sites in the United States: Data synthesis and national estimate	Omara – Sept 2018	3.5 times too low	570,000

Recent studies show a dynamic change in leak rate. It appears the Littlefield study and the Alvarez study used the same measurement data, but there is a significant increase in leak rate between the two.

<b>EDF Study or Report Title</b>	<b>Primary Study Author</b>	<b>Methane Leak Rate</b>
Methane emissions from natural gas production sites in the United States: Data synthesis and national estimate	Omara – Sept 2018	3.4%
Assessment of methane emissions from the US oil and gas supply chain	Alvarez – July 2018	2.3%
Synthesis of Recent Ground-level Methane Emission Measurements from the U.S. Natural Gas Supply Chain	Littlefield - January 2017	1.7%

**New Wells:**

Leaks can be found at new and existing facilities. Data provided by the American Petroleum Institute (API) to EPA shows that the number of leaking components per site during initial instrument-based inspection is less than 2, and falls to less than 1 in subsequent surveys. ([link](#)) This dataset consisted of 6,000 total surveys across 3,482 sites and 13

operators across CO, LA, ND, NM, OH, OK, PA, TX, WY. The percent of sites where zero leaks were found is 58% and the average number of leaks found per site was 1.42 for the first survey and declines for subsequent surveys.

#### Existing Wells:

Leaks can be found at new and existing facilities.

#### How are the emissions calculated for this equipment or process?

US EPA provides multiple methods for estimating fugitive emissions which can be found at the link below. Traditionally, most operators use an approach that was based on site major equipment counts (i.e. number of separators, wellheads, etc.), default component counts (i.e. valves, flanges, etc.) per piece of major equipment, and default emission factor per component (i.e. average scf per hour per valve) that includes an assumed percentage of leaking components based on field work in the 1990s. Revisions to the EPA methods linked to OOOOa reporting, but voluntarily open to operators for use for sites not subject to OOOOa sites, use actual leak occurrence rate from instrumented surveys and a leak/no leak emissions factor. This method is just beginning to be required for OOOO sites but it does appear that when operators switch from the assumed leak occurrence rate to actual leak occurrence rate, emissions estimates are lower.

Equation from GHGRP Subpart W: [https://www.ecfr.gov/cgi-bin/text-idx?SID=3393fe39418e975c59618f6249f55516&mc=true&node=se40.23.98\\_1233&rgn=div8](https://www.ecfr.gov/cgi-bin/text-idx?SID=3393fe39418e975c59618f6249f55516&mc=true&node=se40.23.98_1233&rgn=div8)

#### What data is available to quantify emissions/waste for this equipment or process?

The US EPA publishes most of the emission information and activity data that it receives as part of the US GHG Reporting Program annually ([https://ghgdata.epa.gov/ghgp/main.do?site\\_preference=normal#](https://ghgdata.epa.gov/ghgp/main.do?site_preference=normal#)). By March 31<sup>st</sup> of each year, operators upload their emission information based up on the annual national average and prescribed EPA methodologies to the EPA website for the previous year (i.e. 2018 emission information was reported in March 2019), EPA undertakes a quality assurance process, and uploads the information in October to a publicly accessible website. Care should be taken in estimating emissions from this inventory for New Mexico since both the Permian and San Juan Basins span multiple states and it's challenging to separate emissions between states for all source categories. In the analysis below, NM data was separated from surrounding state data utilizing DrillingInfo data (a database of state well permit information). Also, operators with less than 25,000 MT CO<sub>2</sub>e emissions are exempt from reporting emissions to the GHGRP. Therefore, for the production segment, all emissions were scaled up to the total well count reported by the New Mexico Oil Conservation Division (NMOCD) (EIA for national). For the G&B segment, there is no information to enable scaling-up GHGRP reported emissions and raw GHGRP reported emission quantities are shown.

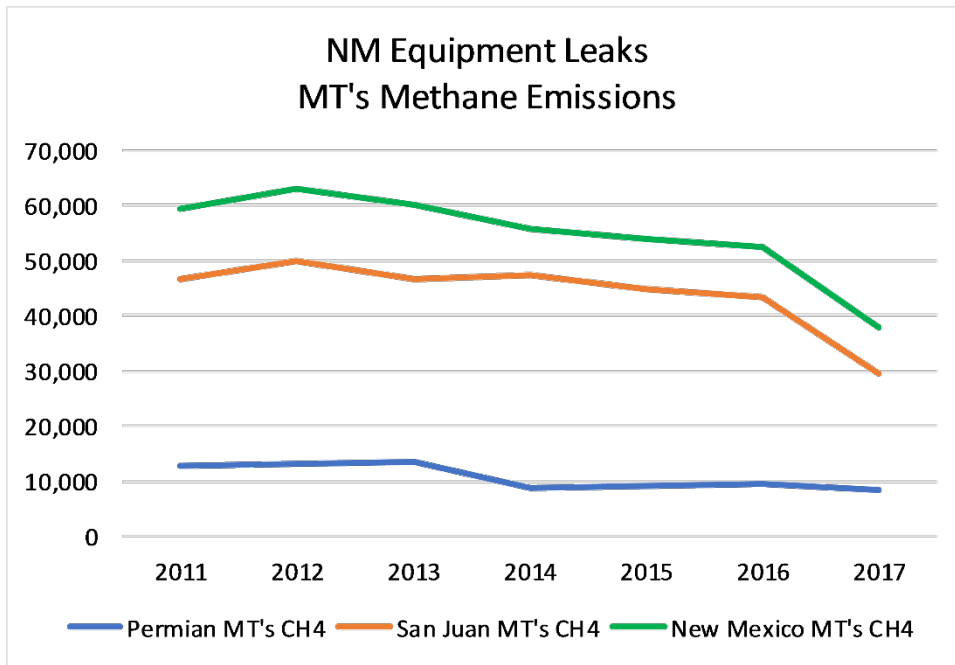

NM equipment leak methane emissions

Analysis of GHGRP data found in the New Mexico Oil and Gas Association's Methane Mitigation Roadmap: <https://www.nmoga.org/methaneroadmap>

**What are the data gaps in quantifying emissions/waste for this equipment?**

Numerous studies have measured emission rates from specific types of oil and gas sources, including equipment components that are the primary focus of LDAR programs. Other types of studies have conducted off-site measurements (such as ambient methane concentration data collected on roads near sites using [OTM33a](#)) or detection of emissions (such as from aerial helicopter surveys) and have inferred emission rates based on atmospheric modeling or other indirect methods. While different study approaches can provide different information on methane emissions, the most useful studies for assessing emission detection and mitigation from LDAR components focus on approaches that provide component-specific information and that utilize proven tools deployed in the upstream oil and gas industry.

Leak data on marginal wells is very limited and warrants further study through objective, transparent, repeatable, and reliable emissions measurements.

Different industry trade associations have collected information on the number and frequency of leaks detected under existing Federal and state-level programs. As with typical LDAR programs, the number of leaks detected and repaired are recorded but quantification of the detected leaks was not reported.

- A recent review of NSPS OOOOa leak survey data indicates that annual inspection frequency is appropriate for non-marginal well sites or facilities.<sup>24</sup> . ([link](#)) Data from various federal and state and inspection programs, including Colorado, demonstrates that the initial component leak rate from initial inspection surveys, show a significantly lower

<sup>24</sup> <https://www.regulations.gov/document?D=EPA-HQ-OAR-2017-0483-0015>

number of leaks than previously assumed. For example, an API analysis of initial NSPS OOOOa inspections showed that only 0.4% of components are found to be leaking during the initial inspection. ([link](#))

- West Slope Colorado data represented in the figure below from 6 operators at 1,700 facilities showed a 0.74 component leaks per site with emissions less than 6 tons per year VOC. ([link](#))

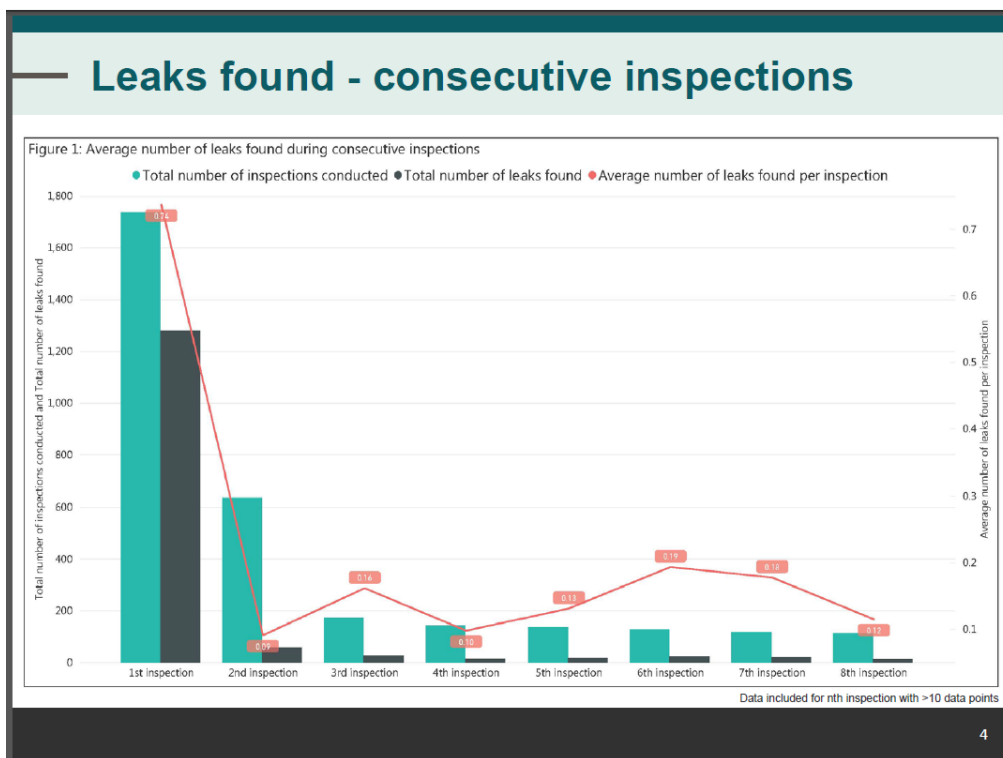

- Additionally, the number of leaks found in inspections at subject facilities in Colorado show a 52% decrease in the number of leaks from 2015 to 2017, while the number of facilities inspected increased by 9%.<sup>25</sup>

Several peer-reviewed studies have also assessed equipment leak emissions more directly by utilizing typical LDAR tools (FLIR cameras, sniffers, etc.) to detect leaks on sites and specialized tools like high volume samplers to quantify emissions from detected leaks. Due to the time requirements for quantification, the sample sizes of sites tend to be smaller than the data presented from industry LDAR programs like those mentioned in the bullets above. In total, these studies have typically found that emission estimates for equipment leaks (leaking valves, flanges, etc.) that are similar to or lower than emission estimates used in EPA reporting. These studies include:

- Researchers at the University of Texas at Austin led a field campaign ([link](#)) that measured methane emissions at 190 new onshore gas well sites in the United States, including from 278 identified equipment leaks. The study developed regional emission factors for estimated methane emissions from equipment leaks per well to compare with methods that EPA had utilized for estimating emissions for national emission inventories at the time of the study and found that emissions per well were similar to EPA emission factors at the time. EPA has since changed its approach for estimating equipment leaks nationally to reflect the equipment-specific information that is available through the GHGRP.
- A 2015 field campaign ([link](#)) that was funded by the American Petroleum Institute (API) included leak detection at 67 production and gathering and boosting sites throughout the Western United States with both a FLIR camera and

<sup>25</sup> <https://www.colorado.gov/pacific/cdphe/2017-ldar-annual-reports-regulation-7-section-xvii>

a sniffer as well as quantification of all leaks determined with either method. The study found a leak rate of 0.39% of components surveyed and that quantified emission rates from equipment leaks were 22%-36% less than would have been calculated from EPA emission factors based on site-level component counts. The study also notes that the study upon which current EPA emission factors were based from the early 1990's identified 1.77% of components as leaking with a sniffer versus 0.35% with the same technology (sniffer) and leak definition (500 ppm) in the 2015 field campaign.

- A study of 25 natural gas sites in California ([link](#)) found that component-level emission factors (i.e. methane emissions per valve) were lower than those used in EPA GHG reporting.

To our industry knowledge, no specific peer-reviewed studies have been undertaken to develop New Mexico-specific emission factors for equipment leaks. The API 2015 field campaign did include measurements in the San Juan and Permian Basins, but metadata to identify the location at the state-level was not provided with the study results. The table below compares the study results in the Permian and San Juan Basins to the other basins in the study (Anadarko and Eagle Ford). Note that the study sample sizes at the basin level are small and the statistical significance of such comparisons has not been verified. Sites measured in the Permian Basin tended to have a smaller fraction of leaking components and overall emissions than those in other geographic regions in the study.

Basin	Number Sites	Number of Components Screened	# Leaks Identified	Equipment Leak Emissions Measured (scfh)	Percent of Components Identified as Leaking	Emissions (scfh)/Site
San Juan	10	10012	45	241.3	0.45%	24.13
Permian	13	19027	43	65.7	0.23%	5.05
Other Basins	42	54921	238	1125.8	0.43%	26.81

### Economic Description of the Process or Equipment:

What is the per unit cost of the equipment or the costs associated with the process?

Costs vary widely based upon type of component and type of service.

A good quality FID might cost approximately \$10-\$15,000, while a new OGI camera costs an estimated between \$85,000 and \$110,000 depending on whether it has one fixed lens or multiple lenses.

<https://www.trinityconsultants.com/news/federal/the-tangled-web-of-ldar-requirements-for-the-oil-and-gas-industry>

FLIR® and Opgal® are the two main players in the OGI market, with both companies supplying EPA-recognized cameras that can be used to demonstrate compliance with federal LDAR rules. If quantification of emissions is desired, the FLIR GF320 camera can be used with a Providence Photonics QL320 tablet to quantitate the emissions. This QL320 tablet has an

approximate \$20,000 cost. The FLIR® GF77® is a new uncooled infrared camera on the market that can visually detect methane for a lower estimated price of \$50,000.

Neither camera is capable of speciation.

#### What are the annualized operating costs for the equipment or costs associated with the process?

Costs vary widely based upon type of service.

Depending on financial constraints or business models, companies have two basic options to conduct LDAR inspections. First, a company can purchase its own equipment and hire employees to conduct its LDAR functions. However, a company can also hire a third-party contractor to use its equipment to perform LDAR services. Though pricing can fluctuate, a 2014 study determined that average cost of hiring an external service provider to conduct OGI LDAR surveys was estimated to be \$2,300 for a compressor station, \$5,000 for a gas plant, \$1,200 for a multi-well battery, \$600 for a single well battery, and \$400 for a well site. [https://ourenergypolicy.org/wp-content/uploads/2014/03/Carbon\\_Limits\\_LDAR.pdf](https://ourenergypolicy.org/wp-content/uploads/2014/03/Carbon_Limits_LDAR.pdf)

That being said, the state of Colorado estimates an estimated inspection cost of \$450, Rebellion Photonics was quoted at \$250 per site, and Jonah Energy estimated a cost of \$99-\$29 per inspection. <http://www.methanefacts.org/files/2016/05/LDAR-Fact-Sheet-FINAL.pdf>

If a company chooses to hire its own employees for the LDAR function, the starting salary for such a technician is somewhere in the \$15-\$20 per hour range, though shortages in a hot market may affect that cost.

Glassdoor's "Gas Leak Survey Technician" job category shows the following average rates:— \$47,831 annual/2080 hours (conservative, no vacation, no sick leave, no benefits) = \$23/hour

[https://www.glassdoor.com/Job/gas-leak-survey-technician-jobs-SRCH\\_KO0,26.htm?srs=TAB\\_OVER\\_SALARY\\_SEARCH](https://www.glassdoor.com/Job/gas-leak-survey-technician-jobs-SRCH_KO0,26.htm?srs=TAB_OVER_SALARY_SEARCH)

Permian salary: \$1,100/week or \$27.5 per hour per Dallas Federal Reserve.

Maintenance procedures are occasionally required on gas sniffers and are estimated to be \$500 - \$1,500 annually. This would not include the replacement of photo-ionization bulbs or calibration gases. Calibration gas costs are estimated to be \$500 - \$1,500 annually, while carrier gas costs may double that estimate if not readily available. If conducting soap bubble-based LDAR procedures, annualized equipment and supply costs are minimal.

Though not mandated, internal and third-party audits of a facility LDAR program are considered an LDAR best practice per the EPA's *Leak Detection and Repair – Best Practices Guide*. An audit checks that the correct equipment is being monitored and that Method 21 procedures are being followed, leaks are being fixed, and that the required records are being kept.

Note: EPA's guide is intended for refineries and chemical plants.

Camera users require training. One course with publicly available information shows \$2,000 and three days for the basic certification. <https://courses.infraredtraining.com/index.cfm?action=registration.schedule&courseId=3>

The below text is from FLIR, a manufacturer of optical gas imagers, noting their recommendation that cameras be calibrated annually.

<https://www.flir.com/support-center/Instruments/service/calibration-technical-data/>

### Camera Calibration Technical Data

All FLIR infrared cameras are precision instruments that are factory calibrated to record the best possible thermal images and non-contact temperature measurements. Moreover, electronic stabilization circuitry helps maintain this calibration as temperature varies. Nevertheless, electronic component aging over time can cause calibration shift.

This means that your FLIR camera should be checked periodically for measurement accuracy and recalibrated as needed. We recommend this be done annually.

# Camera Calibration Technical Data

All FLIR infrared cameras are precision instruments that are factory calibrated to record the best possible thermal images and non-contact temperature measurements. Moreover, electronic stabilization circuitry helps maintain this calibration as temperature varies. Nevertheless, electronic component aging over time can cause calibration shift. This means that your FLIR camera should be checked periodically for measurement accuracy, and recalibrated as needed. We recommend this be done annually.

<https://www.flir.com/discover/professional-tools/how-do-you-calibrate-a-thermal-imaging-camera/>

## How Do You Calibrate a Thermal Imaging Camera?

Calibrating a thermal camera is the process of correlating what the camera sees (infrared radiation) with known temperatures, so that the camera can accurately measure the radiation it detects. All FLIR cameras are calibrated to factory specifications, but over time, electronic component aging can cause calibration shift and produce inaccurate temperature measurements.

If this happens, can you recalibrate your thermal camera by yourself? Unfortunately, the answer is no: to maintain the accuracy of your thermal camera, you will need to send it in for [regular calibration by the camera manufacturer](#). We recommend this be done annually.

End text from FLIR website.

Annual maintenance costs about \$1500 - \$2000.

### If the equipment or process is powered, what are the costs?

Electricity need varies based upon the type of component. Most components in a leak program do not require electricity.

### What are the maintenance and repair costs for existing or new equipment?

Costs vary widely based upon type of service and type of unit.

If measuring accurate temperatures are important, an annual calibration is required on FLIR GF320 cameras. This cost for this required factory calibration is estimated to be \$2,000 per single lens. Annual calibrations are not recommended for FLIR gas finding cameras. Toxic vapor analyzers, flame ionization and photo-ionization detectors, and OGI's have a useful life of an estimated 10-15 years, if properly maintained.

Additional costs include mapping, tagging and recordkeeping

## Existing Reduction Strategies:

### How has industry reduced emissions/waste from this equipment or process historically?

There are two main strategies for reducing leak emissions:

1. Operator Routine Duties: Operators and contractors are given training and/or a checklist of activities to complete on each visit, including listening for leaks, looking for signs of potential leaks (i.e. frozen equipment), and examining operating parameters (drop in sales, SCADA indicators). Operators wear LEL (lower explosive limit) monitors for safety that detect emissions. These strategies are generally employed more frequently and are successful at catching larger leaks.
2. Instrument Based Leak Detection and Repair: Utilizing an instrument (generally optical gas imaging or a handheld gas detector “sniffer”) at a prescribed frequency. Sniffer based programs have existed for decades, optical gas imaging is newer, but has been in use for a decade. In the past few years, there has been significant investment into new technologies, outlined below.

### New Wells:

N/A

### Existing Wells:

N/A

### How have the emission/waste reductions been measured?

Utilizing EPA GHGRP emissions calculations.

### How have states and the federal government reduced emissions/waste from this equipment or process historically? In addition, please identify voluntary reductions achieved whether or not they were in response to a regulatory action/requirement.

Federal Regulations

NSPS OOOOa requires semi-annual inspections at well sites and quarterly inspections at compressor stations. The definition of modification of a wellsite includes adding production to an existing battery, even if that battery remains below the original throughput levels. This means that many centralized facilities built before OOOOa was in effect are subject to the leak provisions. Similarly, the definition of a modification at a compressor station includes adding a compressor to an existing compressor station or replacing an existing compressor with one of greater horsepower. Modified compressor stations also become subject to leak provisions even if they were built before OOOOa went into effect.

OOOOa allows for surveys using optical gas imaging or handheld gas detectors. There is a process to request permission to utilize alternative technologies but the process is generally viewed as onerous and no technology has been approved. The approval process requires over one year, and is only applicable to one site if approval is received. At this point, we are aware of no operator who has requested approval of an alternative technology.

[https://ecfr.io/Title-40/sp40.8.60.oooo\\_0a](https://ecfr.io/Title-40/sp40.8.60.oooo_0a)



## State Regulations

The April 12, 2018 EPA Memo regarding the *Equivalency of State Fugitive Emission Programs for Well Sites and Compressor Stations to Proposed Standards at 40 CFR Part 60, Subpart OOOOa* summarizes the requirements of various state fugitive emissions programs. Summary tables for each state program are in the memo.

[https://www.epa.gov/sites/production/files/2018-09/documents/equivalency\\_of\\_state\\_fugitive\\_emissions\\_programs\\_for\\_well\\_sites\\_and\\_compressor\\_stations.pdf](https://www.epa.gov/sites/production/files/2018-09/documents/equivalency_of_state_fugitive_emissions_programs_for_well_sites_and_compressor_stations.pdf)

Texas requires fugitive emission leak inspections at various frequencies, depending on the level of facility-wide potential emissions and the type of air permit issued to the facility. Under certain permitting mechanisms, the inspection frequency can be reduced to annual if the percentage of leaking components is consistently low. If the percentage of leaking components increases, then the inspection frequency also increases. The state allows optical gas imaging, handheld sniffers, and routine personnel duty AVO inspections under the various programs. Fugitive emission control credits are also allowed depending on the stringency of the Best Available Control Technology (BACT) program implemented.

[https://www.tceq.texas.gov/permitting/air/guidance/newsourcereview/fugitives/nsr\\_fac\\_eqfug.html](https://www.tceq.texas.gov/permitting/air/guidance/newsourcereview/fugitives/nsr_fac_eqfug.html)  
<https://www.tceq.texas.gov/assets/public/permitting/air/Guidance/NewSourceReview/fugitive-guidance.pdf>

Colorado's Regulation 7 Section XVIII <https://drive.google.com/file/d/168v7vMsFJtS7D8BWlnMbaXWA6uZUIyj8/view> Requires inspections at a frequency determined by the sites potential to emit and by whether it is in an attainment or non-attainment area. The state allows optical gas imaging, handhelds, and has approved a small number of alternative technologies.

In Colorado, regulations require an initial survey within 30 days of commencing operation or rule application for existing sources. The inspection frequency is tiered depending on actual fugitive VOC tpy emissions as follows:  
Compressor stations: 0-12: Annual; 13-50: Quarterly; Over 50: Monthly. Well sites: 0-6: One-time; 7-12: Annual; 13-50: Quarterly; 50 and above: Monthly; Multi-well sites >20TPY without tanks: Monthly. Additionally, Colorado operators must use OGI, Method 21 or another approved technology. The rules also create incentives for using continuous emission monitors. If operators choose to use Method 21, there is a 500 ppm leak threshold (new compressor stations and new and existing well sites) and 2,000 ppm (existing compressor stations). Monitoring for LDAR applies to storage tanks and traditional components as well. Repairs must be made within 5 days, unless a delayed repair is warranted. If delayed, repairs must be made within 15 days after the delay ceases (e.g., receipt of part if part not in stock).<sup>26</sup> Colorado is also proposing new rules for LDAR which would increase the inspection frequency to semi-annual for compressor stations with VOC emissions greater than 0 and less than 12 tpy, on a rolling 12-month basis. The proposed rules would also require owners or operators of well production facilities with estimated uncontrolled actual VOC emissions greater than or equal to 2 but less than or equal to 12 tpy, based on a rolling twelve-month total, to inspect components for leaks using an approved instrument monitoring method at least semi-annually.<sup>27</sup>

In a review of the Colorado Air Pollution Control Division (APCD) analysis, it references "cost effectiveness" of various components of the LDAR program in units of cost(\$)/ton, but does not reference LDAR as highly cost effective implying positive net present values, particularly in the marginal well sector of the industry. In fact, the cited COST-BENEFIT ANALYSIS SUBMITTED PER 24-4-103(2.5), C.R.S. states that in addition to the direct costs of LDAR, implementation of the proposed strategies could potentially result in the shut-in of marginally producing wells, resulting in indirect costs in the form of lost revenues to oil and gas companies, loss of jobs associated with these facilities, lost royalty payments, and lost

<sup>26</sup> Colorado Air Quality Control Commission, 5 C.C.R. 1001-9, CO Reg. 7, § XVII.F. (Feb. 24, 2014), available at <https://drive.google.com/file/d/168v7vMsFJtS7D8BWlnMbaXWA6uZUIyj8/view>

<sup>27</sup> Colorado Air Quality Control Commission, proposed revisions to Regulation 7, available at <https://drive.google.com/drive/folders/14ft4C0Tzl79to4c2tVuLDKucksk5uaB>

severance taxes. Based on available information the CAPCD found it could not reasonably calculate the amount of oil and gas that could be shut-in due to the proposed rule. All this at a natural gas price of \$3.50/Mcf that the CAPCD used for calculation purposes in preparation for the 2014 hearing. After deducting lease bonus and New Mexico production tax deductions, \$3.50/Mcf is a Henry Hub wellhead price that has not been seen on an annualized basis for the last 10 years, nor during the first 9 months of 2019 (EIA data). The average 9-month year-to-date Henry Hub wellhead price is \$1.93/Mcf before basis, midstream or pipeline transportation, processing, dehydration, or compression costs are deducted. Furthermore, the CAPCD recognized that smaller companies cannot fully utilize an in-house inspection program and therefore would have to use a higher cost third party contractor for inspections. For well and well production facilities, the CAPCD assumed that any company with 500 or more inspections per year would conduct inspections in-house, and that companies with less than 500 inspections per year would use third party contractors. Using this assumption in New Mexico with the IHS statewide dataset of over 400 New Mexico operators reveals 4.8% operate 500 or more wells each, and 95.2% operate less than 500 wells each and would be using the more costly third-party services.

California requires LDAR at an annual or quarterly frequency depending on when the component came under an LDAR program. The state allows optical gas imaging or handhelds, though Air District programs may require handhelds. Heavy oil (API gravity 20 or less) bearing components are exempt from the program.

See <https://ww2.arb.ca.gov/sites/default/files/2018-06/2017%20Final%20Reg%20Orders%20GHG%20Emission%20Standards.pdf>

In California, owners or operators must conduct quarterly inspections using Method 21. After January 1, 2020, there will be a 1,000 ppm leak threshold for repairs. Leaks must be repaired within 2, 5 or 14 days, depending on the size of the leak. Components or component parts which incur 5 repair actions within a continuous 12-month period must be replaced and re-measured to determine that the component is below the minimum leak threshold.<sup>28</sup>

In Wyoming, New and Existing facilities must be inspected quarterly for leaks of 4 tpy or more of VOCs. Operators in Wyoming must record dates and results of LDAR inspections, including the date and type of corrective action taken as a result of the inspections. Components to be inspected include flanges, connectors, open-ended lines, pumps, valves, and "other" components listed in EPA Table 2-4. Operators must inspect using OGI, Method 21 or another approved technology.<sup>29</sup> Note this is for the non-attainment area.

Utah requires operators to develop an emissions monitoring plan that must include: (i) monitoring frequency; (ii) monitoring technique and equipment; (iii) procedures and timeframes for identifying and repairing leaks; (iv) recordkeeping practices; and (v) calibration and maintenance procedures for monitoring equipment. The plan must address monitoring for difficult-to-monitor & unsafe-to-monitor components. Operators must conduct monitoring surveys on site to observe each fugitive emissions component. The schedule for monitoring surveys is as follows: (i) No later than 180 days after 1/1/2018, or no later than 60 days after startup of production, whichever is later. (ii) Semiannually after the initial monitoring survey. Consecutive semiannual monitoring surveys conducted at least 4 months apart. (iii) Annually after the initial monitoring survey for "difficult-to-monitor" components. (iv) As required by the owner/operator's monitoring plan for "unsafe-to-monitor" components. Operators must use OGI or Method 21 or both. If fugitive emissions are detected, operators must repair the component as soon as possible but no later than 15 calendar days. If repair or replacement is technically infeasible, would require a vent blowdown, a well shutdown or well shut-in, or would be unsafe to repair during operation of the unit, repair or replacement shall be completed during the next well shutdown, well shut-in, after an unscheduled,

---

<sup>28</sup> 17 C.C.R. § 95669 (March 24, 2006), available at <https://www.arb.ca.gov/cc/oil-gas/Oil%20and%20Gas%20Appx%20A%20Regulation%20Text.pdf>

<sup>29</sup> WDEQ, Oil and Gas Production Facilities Ch. 6, Section 2 Permitting Guidance for the UGRB (2016), available at <http://deq.wyoming.gov/media/attachments/Air%20Quality/New%20Source%20Review/Guidance%20Documents/5-12-2016%20Oil%20and%20Gas%20Guidance.pdf>

planned or emergency vent blowdown or within 24 months, whichever is earlier. Operators must resurvey repaired or replaced fugitive emission component no later than 30 calendar days after fugitive emission component is repaired.<sup>30</sup>

Ohio and Pennsylvania both require LDAR for new sources. In Ohio, the Initial inspection must be within 90 days of startup and then quarterly for the next 4 quarters. Operators can step down to semi-annual after 4 consecutive quarters with no more than 2% of components leaking and down to annual after 2 consecutive semi-annual inspections if no more than 2% of components leaking. Operators must step up to the original quarterly inspections whenever 2% or more of components are leaking. Acceptable inspection methods include FLIR cameras or Method 21 compliant analyzers.<sup>31</sup> In Pennsylvania, GP 5 covers sources at natural gas compression stations, processing plants, and transmission Stations, and requires quarterly LDAR. GP 5A covers sources at unconventional natural gas well sites, and requires quarterly LDAR with step down to semi-annual based on 2% of components leaking after 2 consecutive inspections. Operators must step back up to quarterly inspections if more than 2% of components are found leaking at any time. Modified existing wells (those that are re-fracked) are also subject to this requirement.<sup>32</sup>

The field of leak detection technology is evolving rapidly. Emerging technologies and inspection methods, such as mobile mounted IR cameras and lasers, and continuous stationary monitors, have the potential to significantly cut down on inspection time while also increasing the speed at which leaks are detected. EPA, a handful of states including Colorado, Wyoming, and Pennsylvania, and the countries of Canada and Mexico have revised their rules and General Permits to include a provision that allows operators to request approval to use an alternative leak detection method or technology in order to provide a pathway for approval of these innovative approaches. Colorado's alternative compliance pathway provides a good example. Colorado requires that an alternative method must be able to demonstrate it is capable of achieving emission reductions that are at least as effective as the emissions reduction achieved using an IR camera or EPA Reference Method 21.<sup>33</sup> In addition, the proposed alternative must be commercially available.<sup>34</sup> Applicants must provide detailed information on the alternative technology or method, including but not limited to, its limitations, the process for recordkeeping, whether it has been approved for other applications or by other regulators, and any modeling results or test data.<sup>35</sup> Colorado allows manufacturers of alternative instrument monitoring methods (AIMM), as well as operators, to apply to use an alternative AIMM. Approved AIMM may be used by any operator in Colorado to comply with well production facility and compressor station LDAR inspections. In addition, approved AIMM may be used to conduct inspections of pneumatic controllers in the Denver nonattainment area.<sup>36</sup> In Colorado, the application and approval process are subject to public notice and comment if the request is for use in the Denver metropolitan ozone nonattainment area.

Internationally, Mexico requires quarterly LDAR and inspection frequency is tied to emission thresholds.<sup>37</sup> Canadian operators must have an LDAR program and inspections must occur three times a year. LDAR in Canada applies to all sources of unintentional venting and traditional components but is not applicable at standalone well heads.<sup>38</sup>

<sup>30</sup> U.A.C. Rule 307-509, available at <https://rules.utah.gov/publicat/code/r307/r307-509.htm>

<sup>31</sup> Ohio EPA General Permit 12.1 and 12.2, available at <http://epa.ohio.gov/dapc/genpermit/oilandgaswellsiteproduction.aspx>; Ohio GPs for compressor stations, available at <http://epa.ohio.gov/dapc/genpermit/ngcs.aspx>

<sup>32</sup> Department of Environmental Protection, Air Quality Permit Exemption 38, available at <http://www.elibrary.dep.state.pa.us/dsweb/Get/Document-96215/275-2101-003.pdf>

<sup>33</sup> 5 C.C.R. 1009-1 § XII.L.8.a(ii)(I); CDPHE, *Alternative AIMM Guidance and Procedures*, p. 1 (May 31, 2018) (accessible at [https://drive.google.com/file/d/1reFIFX\\_DV1\\_Wcu82853NNekmhjOtljui/view](https://drive.google.com/file/d/1reFIFX_DV1_Wcu82853NNekmhjOtljui/view)).

<sup>34</sup> Id. at § XII.L.8.a(ii)(B); *Alternative AIMM Guidance and Procedures*, p. 2.

<sup>35</sup> Id. at § XII.L.8.a(i); *Alternative AIMM Guidance and Procedures*, p. 1.

<sup>36</sup> *Alternative AIMM Guidance and Procedures*, p. 1.

<sup>37</sup> Mexico, Agencia de Seguridad, Energia y Ambiente (ASEA) regulations, available at [http://www.dof.gob.mx/nota\\_detalle.php?codigo=5543033&fecha=06/11/2018](http://www.dof.gob.mx/nota_detalle.php?codigo=5543033&fecha=06/11/2018)

<sup>38</sup> Regulations Respecting Reduction in the Release of Methane and Certain Volatile Organic Compounds (Upstream Oil and Gas Sector) (July 2019). Available at <https://laws-lois.justice.gc.ca/PDF/SOR-2018-66.pdf>

Note, no current state or federal rules allow for easy adopting of new technologies, nor do they allow the flexibility that would be required for companies to adopt new technologies.

**What are examples of process changes/modifications that reduce or eliminate emissions/waste from this equipment or process?**

Limiting the number of components where leaks can occur is one potential process modification, however, this is not often feasible due to operational needs for components. Lowering pressure could potentially reduce the volume of emissions from a leak. Other papers provide information on need for and opportunities to reduce components.

Per the EPA's *Leak Detection and Repair – Best Practices Guide*, "Facilities can control emissions for equipment leaks...by modifying/replacing leaking equipment with "leakless" components. Emissions from pumps and valves can also be reduced through the use of "leakless" valves and "sealless" pumps. Common leakless valves include bellows and diaphragm valves, while common sealless pumps include diaphragm pumps, canned motor pumps, and magnetic drive pumps. Leaks from pumps can also be reduced by using dual seals with or without barrier fluid.<https://www.epa.gov/sites/production/files/2014-02/documents/ldarguide.pdf>

(note this guidance document is for refineries and chemical plants)

Regarding potential emission leaks from tank hatches, gates, valves, and other mechanisms, the Unico UWS™ Hatch Sense wireless sensor is designed to monitor those devices. <https://www.unicous.com/products/uws-hatch-sense-system> It contains a magnetic proximity switch that detects if the latch on the hatch is open or closed by using Bluetooth Low Energy technology to communicate with a mobile device or a Unico UWS™ Gateway.[https://www.unicous.com/sites/default/files/user\\_files/UWS%20Hatch%20Sense%204.25%20-%20Gateway%20UWS%20Hatch%20Sense.pdf](https://www.unicous.com/sites/default/files/user_files/UWS%20Hatch%20Sense%204.25%20-%20Gateway%20UWS%20Hatch%20Sense.pdf)

Moreover, the use of low bleed or no bleed pneumatic devices, including but not limited to controller boxes, would reduce existing and new methane emissions. Such emissions are relevant as they add to total airshed methane concentrations that would be readily detected by OGI's while conducting LDAR surveys.

## Technology Alternatives:

List of technology alternatives with link to information or contact information for the company/developers.

**What technology alternatives exist to reduce or detect emissions? Please list all alternatives identified along with contact information for further investigation of this technology or process.**

Name/Description of Technology	Link (and contact info for company if available)	Availability	Feasibility	Cost Range (choose one)
Satellite Technologies	<a href="https://www.ghgsat.com/">https://www.ghgsat.com/</a> <a href="https://www.edf.org/climate/space-technology-can-cut-climate-pollution-earth/satellite-talk?gclid=Cj0KCQjwoqDtBRD-ARIsAL4pviCVquAnSTU-omqAqlyBASV79h5DJ">https://www.edf.org/climate/space-technology-can-cut-climate-pollution-earth/satellite-talk?gclid=Cj0KCQjwoqDtBRD-ARIsAL4pviCVquAnSTU-omqAqlyBASV79h5DJ</a>	<b>In use, though not for site level leak detection</b>	Current detection threshold makes identifying specific sites with emissions a challenge	Not yet in common use

	<a href="http://bluefield.co/">PuZpSXejYAwyZIT5pn yHK4Wwb4aAvouEAL w wcB&amp;utm campai gn=edf methanesat upd acq&amp;utm id=15 24073537&amp;utm medi um=cpc&amp;utm source =google http://bluefield.co/</a>			
Aerial basin level surveys	<a href="http://kairosaerospac.com/">http://kairosaerospac.com/</a> <a href="https://www.bridgerphotonics.com/">https://www.bridgerphotonics.com/</a> <a href="http://www.scientificaviation.com">http://www.scientificaviation.com</a>  <a href="https://www.leaksurveysinc.com/">https://www.leaksurveysinc.com/</a>  <a href="https://www.ball.com/aerospace/newsroom/features/light-the-way-with-methane-monitoring">https://www.ball.com/aerospace/newsroom/features/light-the-way-with-methane-monitoring</a>	<b>In some commercial use</b>	Range of detection thresholds, generally an order of magnitude or more greater than optical gas imaging. Therefore, the technologies generally serve as a screening method. If emissions are detected, a crew with a secondary device will need to visit the site to isolate the piece of equipment.	Medium
Site level surveys (aerial drone or truck)	<a href="https://www.seekops.com/">https://www.seekops.com/</a> <a href="http://www.aerodyne.com/aerodyne-mobile-laboratory">http://www.aerodyne.com/aerodyne-mobile-laboratory</a> <a href="https://www.bhge.com/news/bhge-launches-lumen-ground-drone-based-advanced-methane-detection-reduction-system">https://www.bhge.com/news/bhge-launches-lumen-ground-drone-based-advanced-methane-detection-reduction-system</a>  <a href="https://www.elementscience.org/articles/10.1525/elementa.373/">https://www.elementscience.org/articles/10.1525/elementa.373/</a>	<b>In use.</b> For the drone, until there is beyond visual line of site, this is nearly as limited for many places in terms of personnel needing to visit each site, but now requires a much more specialized skilled operator to operate. The cost of the LDAR technician goes up for similar time, resulting in a solution with slightly less detection sensitivity but just as much resource.	Detection at the equipment level is still being piloted, so serves as a screening method. Also may detect non fugitive sources. If emissions are detected, a crew with a secondary device will need to visit the site to isolate the piece of equipment.	Medium -High depending on density and proximity. Currently not approved by regulators except for Optical Gas Imager on drone.  Drones provide major equipment group level information that requires more detailed inspection to identify a specific leaking component.  Trucks provide site-level information

				that will require more detailed inspection to locate component level information (directed LDAR).
Equipment level surveys	<a href="https://www.flir.com/browse/industrial/gas-detection-cameras/">https://www.flir.com/browse/industrial/gas-detection-cameras/</a> <a href="https://www.raesystems.com">https://www.raesystems.com</a> <a href="https://heathus.com/products/rmld-cs/">https://heathus.com/products/rmld-cs/</a>	In use	Medium – Instruments range from ~10-15K (handheld sniffer – see above) to ~100k (optical gas imaging – sited in various regulatory impact assessments), significant personnel time required for both technologies. Handheld sniffer may require significant tagging expense and generally require more time in the field.	<b>Varies with site size / amount of travel time</b>
Fixed/Continuous Monitoring	<a href="#">Troposphere</a> <a href="#">Quanta3</a> <a href="#">Lumen</a> <a href="#">IBM</a> <a href="https://www.projectcanary.com/">https://www.projectcanary.com/</a> <a href="https://rebellionphotonics.com/">https://rebellionphotonics.com/</a>	Being piloted	Generally works as an alarm requiring follow-up. Does not quantify or identify the specific piece of equipment or component. May require meteorological data to corroborate source of readings. Has certain electricity and data management/network requirements.	Still in development with some pilot testing. Provides site-level information that will require more detailed inspection to locate component level information (directed LDAR).

Though not mandated, FLIR GF320 OGI's can be equipped with a [QL 320 quantification tool](#) developed by [Providence Photonics](#). This QL320 can also be used in other FLIR GF series cameras by asking the factory to add the Q Mode for offline processing. By combining these two technologies, it is possible to quantitate emission losses. The QL320 calculates the leak quantity in multiple units (as desired) based on the image and response factors unique to each gas. With continued changes to the software and post-processing capabilities, accuracy of measurements has increased substantially since the first release of the technology. Under correct use, the QL320 can achieve field accuracy of +/- 10% of a one minute running average of emissions rates. Lab results using measured releases have achieved 2% accuracy.

In 2018 – 2019, Earthworks has used the QL 320 to quantify emissions from storage tanks, pipe fitting leaks, pneumatic controller exhaust, unlit flares, and other sources in several states, including 30 measurements in New Mexico from ten different sites in Eddy, Rio Arriba, Sandoval, and San Juan counties. Average leak rates for the New Mexico sites have ranged from 52.44 to 0.2 lbs/hr. The QL 320 quantification software is still in the development phase.

<https://broomfield.ajax-analytics.com/>

This link goes to the Broomfield monitoring site where the monitoring technology, parameters and data are all posted. A year's worth of data has been collected and posted.

TCEQ helicopter flyover program is internally funded by TCEQ's air quality division. There is some information about the TCEQ helicopter program in this presentation:

[https://tipro.org/UserFiles/TCEQ\\_OG\\_Update\\_TIPRO\\_August\\_2018.pdf](https://tipro.org/UserFiles/TCEQ_OG_Update_TIPRO_August_2018.pdf).

#### What are the pros and cons of the alternatives?

While new technologies have shown great promise in detecting emissions at a lower cost, there is generally a tradeoff in terms of detection limit and ability to pinpoint the location of a leak. There is some funding at Colorado State University, who has convened discussions, to continue to develop a next generation of FEAST model which will help inform this and an associated technical project.

#### What is needed and available for new wells?

NSPS OOOOa applies to facilities built after September 18, 2015 or taking new production after that same date. Due to the small number of components, EPA exempts wellhead only facilities.

#### What is needed and available for existing wells?

Marginal wells (< 15 barrels of oil equivalent per day) should be excluded from the LDAR program. Marginal wells, by their nature, are lower producing and generally requires less equipment with fewer components. In fact, data (see API study noted above) has indicated that leak detection is most effective on the initial inspection to ensure that all components and equipment are tightened from the outset and that the frequency of detection lowers over time. These factors mean that the cost of each marginal well LDAR survey often outweighs the benefits of the potential emission reductions and can threaten their financial viability. In the oil-and-gas Control Technique Guidelines, EPA expressly recognized that fugitive emissions at low-production sites are inherently low and thus included an exemption from the LDAR program for well sites with an average production of less than 15 barrels of oil equivalent per day. Unless and until additional comprehensive and conclusive data has been collected to suggest that marginal wells warrant inclusion in an LDAR program, these wells should be excluded. Leak data on marginal wells is very limited and warrants further study through objective, transparent, repeatable, and reliable emissions measurements. The sample size of the current data set is too small to provide conclusive results. Proper inspection methods and associate frequency must be informed by well-established data that can correlate production and emissions. Other factors that must be weighed are type and quantity of equipment, frequency of episodic emission events, equipment age/condition, and absolute contribution to total emissions. The Department of Energy is co-funding such a study titled "Quantification of Methane Emissions from Marginal (Small Producing) Oil and Gas Wells" being conducted by GSI Environmental Inc.

Wellhead only locations should not be included in the LDAR program due to very limited equipment, therefore limited potential to emit, on location, consistent with NSPS OOOOa. Facilities that do not require permits similarly have very limited equipment and should be exempt from a LDAR program. Facilities without controlled equipment would not benefit from an LDAR program as a low level of emissions will occur under allowable permit limits with or without an inspection program.

What technology alternatives exist for this equipment or process itself?

N/A

What are the pros and cons of the alternatives?

See above.

## Costs of Methane Reductions:

What is the cost to achieve methane emission reductions?

It is very difficult to generalize costs due to the wide range of technology applications and other variables such as distance to survey, repair costs, etc. See API LDAR paper in the data section.

Information from various U.S. jurisdictions and independent consulting groups demonstrates that quarterly LDAR inspections are highly cost effective: [note – one member’s opinion]

- **Colorado.** The final cost benefit analysis prepared by the Colorado Air Pollution Control Division (APCD) in support of its LDAR program demonstrates that quarterly inspections are cost effective. For mid-sized well sites, Colorado found the cost effectiveness of quarterly LDAR inspections to be \$1,019 per ton of VOC reduced and \$679 per ton of CH<sub>4</sub>/ethane reduced for facilities located in the Denver non-attainment area. For remote facilities located outside the Denver-Julesburg basin, Colorado determined quarterly inspections to be cost effective at \$1,268 per ton of VOC reduced and \$648 per ton of CH<sub>4</sub>/ethane reduced.<sup>39</sup> Colorado determined that requiring quarterly inspections for compressor stations is cost effective, estimating a control cost of \$2,273 per ton of VOC reduced.<sup>40</sup> In a review of the APCD analysis, it references “cost effectiveness” of various components of the LDAR program in units of cost(\$)/ton, but does not reference LDAR as highly cost effective implying positive net present values, particularly in the marginal well sector of the industry. In fact, the cited COST-BENEFIT ANALYSIS SUBMITTED PER 24-4-103(2.5), C.R.S. states that in addition to the direct costs of LDAR, implementation of the proposed strategies could potentially result in the shut-in of marginally producing wells, resulting in indirect costs in the form of lost revenues to oil and gas companies, loss of jobs associated with these facilities, lost royalty payments, and lost severance taxes. Based on available information the CAPCD found it could not reasonably calculate the amount of oil and gas that could be shut-in due to the proposed rule. All this at a natural gas price of \$3.50 Mcf that the CAPCD used for calculation purposes in preparation for the 2014 hearing. After deducting lease bonus and New Mexico production tax deductions, \$3.50/Mcf is a Henry Hub wellhead price that has not been seen on an annualized basis for the last 10 years, nor during the first 9 months of 2019 (EIA data). The average 9 month year-to-date Henry Hub wellhead price is \$1.93/Mcf before basis, midstream or

<sup>39</sup> Colorado Air Pollution Control Division, Cost-Benefit Analysis for Proposed Revisions to AQCC Regulations No. 3 and 7 (February 7, 2014) (“CAPCD Cost-Benefit”), at 28, Table 34, available at <https://www.regulations.gov/document?D=EPA-HQ-OAR-2010-0505-7573>.

<sup>40</sup> Colorado Air Pollution Control Division, Economic Impact Analysis (Final) for Regulation 7, Sections II., XII., XVII., XVIII. p.5 (October 4, 2017).



pipeline transportation, processing, dehydration, or compression costs are deducted. Furthermore, the CAPCD recognized that smaller companies cannot fully utilize an in-house inspection program and therefore would have to use a higher cost third party contractor for inspections. For well and well production facilities, the CAPCD assumed that any company with 500 or more inspections per year would conduct inspections in-house, and that companies with less than 500 inspections per year would use third party contractors. Using this assumption in New Mexico with the IHS statewide dataset of over 400 New Mexico operators reveals 4.8% operate 500 or more wells each, and 95.2% operate less than 500 wells each and would be using the more costly third party services.

- **California.** The California Air Resources Board (CARB) has found conducting quarterly inspections at production facilities to be highly cost effective. CARB estimates the costs are \$23 per metric ton of CO<sub>2</sub>e reduced (accounting for savings from recovered product) to \$26 per metric ton of CO<sub>2</sub>e reduced (not accounting for savings).<sup>41</sup> These estimates assume a 20-year global warming potential for methane. (Note: current carbon trading price in California is \$15 per metric ton). Again, as in the Colorado citation above, CARB made cost effectiveness comparisons on a cost/ton basis, but made no claim in the citation that quarterly inspections are “highly cost effective” implying positive net present value. Also, as in the California study, an overly optimistic natural gas price of \$3.44/Mcf was used as compared to current and historic Henry Hub wellhead pricing discussed above. The CARB citation was abbreviated as compared to the Colorado study and did not break out the LDAR abatement costs for the well and well facility sector. The LDAR abatement metrics found on page 3 not only included both onshore and offshore well and well facilities, but also facilities involving natural gas processing and natural gas storage. There is a comment about “idle wells” but marginal wells were not mentioned in the CARB study. The LDAR abatement costs in the CARB study are most likely skewed downward by the larger facilities and “super leaker” data and not representative of the well and marginal well sector alone.
- **Carbon Limits Study.** This study is based on actual leak data from over 4,000 LDAR inspections of oil and gas facilities, such as well sites, gas compressor stations, and gas processing plants. The inspectors used infrared cameras to identify over 58,000 individual components that were leaking or venting gas. The inspection firms provided facility inspection costs and, for every leak they found, data such as the size of the leak and how much it would cost to repair. LDAR surveys performed quarterly would abate methane at a net cost of less than \$280 per metric ton (\$11/ton CO<sub>2</sub>e using a global warming potential of 25) for all types of facilities. Per this study, over 90% of the gas leaking from these facilities is from leaks that can be fixed with a payback period of less than one year (assuming gas prices of \$3 per thousand cubic feet).<sup>42</sup>
- The study breaks down facilities into three categories, 1) compressor stations, 2) gas plants, and 3) well and well batteries that include anywhere from 1 to 15 wells per battery. This last category is beneficial to exam as it relates to marginal wells. There were 1,764 surveys of well and well batteries which represents 41% of all surveys. Although the well and well batteries are nearly half of the surveyed components, the study found that fully 36% (one third) of the well sites and batteries had no leaks. The remaining 64% of the well and well facilities were only 5.5% of the total leak rate attributed to all facilities combined. Fully 94.5% of the leak rate is attributed to compressor stations and gas plants. Within the study an economic assessment was run on the well and well batteries category in the form of three economic cases at varying gas prices. The three cases were run at a natural gas price of \$3, \$4, and \$5 per Mcfg respectively with the average or base case being at \$4/Mcfg. As discussed previously this \$4/Mcfg base case price is over 2 times higher than the average 9 month year-to-date Henry Hub wellhead price, and repeating, before any basis, transportation, processing, dehydration, or compression costs are deducted from the Henry Hub price. The study found that the LDAR program on the well and well battery category has the highest percentage of surveys with a negative NPV (positive or negative NPV being the difference between a project being economic versus uneconomic),

<sup>41</sup> CARB. Revised Emission and Cost Estimates for the Leak Detection and Repair Provision, (February, 2017). Available at: <https://www.arb.ca.gov/regact/2016/oilandgas2016/oilgasatt2.pdf>.

<sup>42</sup> Carbon Limits, Fact Sheet, Fixing the Leaks: What would it cost to clean up natural gas leaks?, available at [http://www.catf.us/resources/factsheets/files/LDAR\\_Fact\\_Sheet.pdf](http://www.catf.us/resources/factsheets/files/LDAR_Fact_Sheet.pdf). Full report available at [http://www.catf.us/resources/publications/files/Carbon\\_Limits\\_LDAR.pdf](http://www.catf.us/resources/publications/files/Carbon_Limits_LDAR.pdf).

concluding that over 80% of surveys are uneconomic even with the inflated natural gas pricing. Quoting the study, “This is because leak rates for well sites and batteries are generally smaller than that for gas plants or compressor stations”. As far as a payback of less than one year for repair as stated above, it was found that the repair costs used in the study were seriously underestimated. As an example, an average valve repair is stated to cost \$90. Adding transportation and roustabout crew time in Southeastern New Mexico for the repair puts the cost at \$610 thus the realistic cost of a valve repair is nearly 7 times more than the study states, seriously calling into question the method of costing repairs in the study. The implication derived from this study is that all surveys on marginal wells would be uneconomic, particularly if economics were run at a more realistic natural gas wellhead price. Mandated quarterly surveys on marginal wells would create a situation of premature abandonment and underground waste of resource from the absolute lowest category of emitting facilities as identified by the Carbon Limits study.

- Concerning the exorbitant natural gas pricing used in economics within the older reports and studies cited heretofore, a more recent report prepared for the Environmental Defense Fund by Synapse Energy Economics, Inc. dated September of 2019 is available.<sup>38A</sup> This report utilizes Henry Hub natural gas index pricing and NYMEX forward pricing, less basis, to project the natural gas price for the next 10 years. Per the Synapse report *“Gas prices paid to producers in New Mexico are lower than the Henry Hub price (the most common national benchmark for natural gas prices) because of the cost to transport gas to the national market. This difference between Henry Hub and New Mexico gas prices is called the “basis.”*” Deducting lease burdens and New Mexico production taxes from the Synapse forward pricing yields an average 10 year forward projection of natural gas wellhead pricing in the Permian Basin of \$1.60/MCF. This is a much more realistic natural gas price to utilize for average case economics. The Synapse study projected Permian gas price is 54% lower than the price used in Colorado economics, and 60% lower than the price used for base case economics in the Carbon Limits study.
- **Center for Methane Emissions Solutions, Colorado Case Study.** CMES interviewed 10 companies in Colorado operating after Colorado adopted its LDAR program in 2014. It found that 7 out of 10 companies interviewed reported that additional revenues from fixing leaks more than covers the costs of finding and fixing leaks.<sup>43</sup> An attempt to open the citation rendered a message “website expired”.
- **ICF.** ICF developed a complex model to investigate the distribution of LDAR cost profiles at well sites (Attachment 1). This analysis seeks to develop facility models that replicate real world situations and capture variations in these characteristics by using a Monte Carlo simulation to analyze facility emissions, reductions and costs. These results further demonstrate that quarterly monitoring is cost-effective. ICF’s estimate of the control costs for quarterly LDAR are equal to \$262 per short ton of methane reduced, assuming \$3 gas; \$234 per short ton of methane reduced, assuming \$4 gas; and \$187 per short ton of methane reduced assuming \$3 gas and the use of a contractor to perform the inspection.<sup>44</sup> The attached PowerPoint describes the modeling concepts and model inputs in greater detail. Page 8 of Attachment 1 indicates that the cost(\$)/Mcf-reduced metric is the “ratio of the total cost to conduct an LDAR survey to the difference in Mcf of emissions from the baseline each year where the baseline is assumed to be the uncontrolled emissions in the first year”. This assumption is problematic for monitoring emissions on a depleting hydrocarbon flow rate as the emissions in the first year will diminish from year to year, even without emission controls, as the well producing rate declines. With many southeast New Mexico horizontal wells having an initial hyperbolic decline rate of 90% or more in the first year, this could be a large misrepresentation of the \$/Mcf-reduced metric.

---

<sup>43</sup> Center for Methane Emissions Solutions, Colorado Case Study, available at <https://static1.squarespace.com/static/558c5da5e4b0df58d72989de/t/57110da386db43c4be349dd8/1460735396217/Methane+Study.pdf>.

<sup>44</sup> ICF’s cost effectiveness estimates have been converted into dollars per short tons of methane.

- Industry.** Jonah Energy—an operator in the Upper Green River Basin in Wyoming— has expressed its support of at least quarterly instrument-based inspections,<sup>45</sup> noting that it already complies with the proposal because “each month, Jonah Energy conducts infrared camera surveys using a forward-looking infrared camera (“FLIR”) camera at each of our production facility locations.”<sup>46</sup> According to Jonah, “[b]ased on a market value of natural gas of \$4/MMBtu, the estimated gas savings from the repair of leaks identified exceeded the labor and material cost of repairing the identified leaks” while also significantly reducing pollution.<sup>47</sup> Jonah has reported that this highly cost-effective quarterly LDAR program has reduced fugitive VOC emissions from its facilities by over 75%, indicating that methane and other hydrocarbon losses have also been reduced by a similar proportion.<sup>48</sup> Jonah’s experience that gas savings from repairs often exceed the cost of performing repairs to identified leaks is also borne out by the Carbon Limits report<sup>49</sup> and analysis carried out by Colorado.<sup>50</sup> There is mounting industry-supplied evidence that frequent LDAR is cost-effective.<sup>51</sup>

When Colorado and EPA initially drafted their rules, they had very little data to estimate the number of leaks and the baseline fugitive emissions, so based on aEPA’s1995 Protocol for Equipment Leak Emission Estimates, EPA and Colorado relied upon VOC emission factors in Table 2-4 of the 1995 EPA Leak Protocol. ([link](#)) Figures 5-16 through 5-34 of the 1995 EPA Leak Protocol demonstrate that the VOC emission factors within Table 2-4 correspond to between 1.6% and 2.5% of components that are assumed to be leaking. The lower value represents an assumed 10,000 ppm Method 12 leak definition and the higher value assumes a 500 ppm leak definition. NSPS OOOOa’s leak definition is 500 ppm, which would correlate to the 2.5% component leak rate. In contrast, API surveyed its members and found an average initial leak incidence for all well sites was 0.4% of the components surveyed. ([link](#))The 1995 EPA Leak Protocol contains an alternate set of VOC emission factors in Table 2-8, which allows for the incorporation of an actual % component leak rate that is based upon more recent data such as the API dataset. Establishing a more realistic baseline emission total using Table 2-8 will more accurately reflect the emissions benefit for a cost benefit analysis. Another key component to establishing an accurate and basin specific baseline is to have an accurate and representative % VOC and an accurate and representative fugitive component count by basin.

**What would be the implementation cost?  
For new wells?**

<sup>45</sup> Jonah Energy stated: “We support the [recent Wyoming rule for existing sources in the UGRB], as proposed, with some minor suggested changes [to the proposed tank requirements] outlined below.” Comments submitted to Mr. Steven A. Dietrich from Jonah Energy LLC on Proposed Regulation WAQSR, Chapter 8, Nonattainment Area Regulations, Section 6, Upper Green River Basin Permit by Rule for Existing Sources (April 13, 2015).

<sup>46</sup> *Id.*

<sup>47</sup> Comments submitted to Mr. Steven A. Dietrich from Jonah Energy LLC on Proposed Regulation WAQSR, Chapter 8, Nonattainment Area Regulations, Section 6, Upper Green River Basin Existing Source Regulations (Dec. 10, 2014).

<sup>48</sup> Jonah Energy, Presentation at WCCA Spring Meeting at 16 (May 8, 2015).

<sup>49</sup> Carbon Limits, Quantifying Cost-effectiveness of Systematic Leak Detection and Repair Programs Using Infrared Cameras, 16 (Mar. 2014) (“Carbon Limits 2014”), available at <http://www.catf.us/resources/publications/files/>.

<sup>50</sup> Colorado Air Pollution Control Division used an entirely different method than Carbon Limits to predict that almost 80 percent of repair costs for well facilities will be covered by the value of conserved gas. See CAPCD Cost-Benefit, at Table 30. Table 30 also identifies Total Annual Inspection and Repair Cost at \$22,150,520 and the Total Annual Value of Recovered Natural Gas at \$4,503,532 therefore the value of recovered gas will only cover 20% of the annual inspection and repair cost at the inflated natural gas price of \$3.50/MCF used by CAPCD. At the average 10 year forward wellhead price of \$1.60/MCF derived from the Synapse Report, the recovered gas will only cover 9% of the annual inspection and repair cost.

<sup>51</sup> Several companies that engaged in the development of Colorado’s regulations provided evidence that frequent LDAR is cost-effective. In particular, Noble estimated the cost-effectiveness of Colorado’s tiered program at “between approximately \$50/ton and \$380/ton VOC removed” at well production facilities. (Rebuttal Statement of Noble Energy, Inc. and Anadarko Petroleum Corporation in the Matter of Proposed Revisions to Regulation Number 3, Parts A, B, and C, Regulation Number 6, part A, and Regulation Number 7 Before the Colorado Air Quality Control Commission, at 7).

The cost is ongoing depending on the number and type of repairs, frequency, technology, personnel and distance to sites. There are initial costs linked to purchasing software to plan and track results of surveys, purchasing and insuring equipment and operator training.

#### For existing wells?

See above – costs are the same for new and existing wells. Marginal oil and gas wells (10 BOE/day or less per IOGCC definition) make up 66% of all wells in New Mexico. These wells average 2.5 BOPD for marginal oil wells and 23.3 Mcfd for marginal gas wells<sup>1</sup>. Under an LDAR program, marginal well operators would need third party LDAR inspection services which are currently \$2,000 to \$2,500 per day per day plus travel<sup>2</sup> for optical services. Inspection time per location would need to include prorated travel time for third party vendors from service point to operating basin, travel time from site to site, along with the time required for each site survey. Travel and survey times range from 2.7 to 6.4 hours per site per studies below (Colorado rulemaking)<sup>3</sup>. A quarterly LDAR program using the average time of 4.6 hrs per inspection would increase the average marginal oil well annual direct operating expense<sup>4</sup> by 24% and marginal gas wells would be a larger increase in direct operating expense. The indirect administrative and reporting costs are not included, but would further reduce marginal well profitability. This would have the effect of rendering some marginal wells uneconomic, and increasing the abandonment producing rate on all marginal wells creating a situation of premature abandonment and underground waste of resource.

<sup>1</sup> [https://www.eia.gov/petroleum/wells/pdf/full\\_report.pdf](https://www.eia.gov/petroleum/wells/pdf/full_report.pdf)

<sup>2</sup> Telecon w/ Trinity Consultants, Albuquerque NM<sup>3</sup> "[Economic Analysis of Methane Emission Reduction Opportunities in the U.S. Onshore Oil and Natural Gas Industries](#)", ICF International (2.7 hrs travel time per site), CDPHE Regulatory Analysis <https://www.sos.state.co.us/CCR/Upload/AGOREquest/RegulatoryAnalysisAttachment2013-01217.PDF> (6.4 hrs travel and inspection time per site), Louis Berger Group (5.75 hrs travel and inspection time per site), Terracon (3.6 hrs travel and inspection time per site).

<sup>4</sup> <http://www.nswa.us> (National Stripper Well Association)

#### *Economic Analysis of Methane Emission Reduction Opportunities in the U.S. Onshore Oil and Natural Gas Industries (ICF Report):*

This report created an array of cost effectiveness calculations in \$/mcf based on a series of critical assumptions. The report touts its findings as demonstrating that methane emissions can be reduced with technologies that only cost cents per day. While aggregating all of the cost effective technologies with the cost ineffective technologies might produce such a result, individual technology options do not. Equally significant are the ICF report assumptions of the value of natural gas in calculating the benefits of regulations and the efficiency of the requirements. These are particularly important in the context of the fugitive emissions proposals.

The ICF Report concludes that a quarterly fugitive emissions program for natural gas wells would recover 264 mcf/y using a 60 percent recovery rate on emissions of 440 mcf/y and have a cost burden of \$7.60/mcf without recovery benefits and \$2.52/mcf with recovery.

Putting this evaluation in some context changes the perspective. First, looking at the emissions and recovery quantities on a daily basis shows them to be 0.72 mcf/d and 1.2 mcf/d, respectively. These are small volumes for even the average well. The ICF Report does not indicate the average production rate for the wells it assumes for the average emissions, but the average US natural gas well produces about 127 mcf/d. Therefore, the approximate emissions rate would be about 1.0 percent. Nor does The ICF Report appear to distinguish sources of emissions in its fugitive discussion. For example, it does not discuss the share of emissions coming from equipment and those coming

from storage tanks that have permitted releases. Since an LDAR program would not apply to these allowable emissions, the efficiency/cost estimates must be questioned.

A second key point of the analysis relates to the value of natural gas where The ICF Report assumes a price of \$4.00/mcf. Producers have not received such a price for a long time and do not foresee such a price for many years. Assuming a price for natural gas at \$2.22/mcf of which the producer receives approximately \$1.67/mcf, the value of the recovered natural gas would drop from \$1360 to \$440 annually. Correspondingly, the cost effectiveness would change in the net case from \$2.52/mcf to \$5.48/mcf.

A third point relates to the scope of fugitive leaks of the Leak Detection and Repair (LDAR) program. A study done by Carbon Limits (described below) concluded that fugitive leak emissions at well sites accounted for 17 percent of the total site emissions. Using this assessment of the 440 mcf/y of site emissions, only 75 mcf/y would be addressed by the LDAR program. And using the generous assumption of a 60 percent recovery, 45 mcf/y (0.12 mcf/d) would be recovered. This would result in \$75 in recovered value. The cost effectiveness would then become \$44.58/mcf in the gross case and \$42.91/mcf in the net case

More critically, the issue of larger significance here is the application of an LDAR program to low production wells. These wells average about 24 mcf/d rather than 127 mcf/d. Moreover, in some significant natural gas producing states the average low production natural gas well is much less; in Pennsylvania, for example, it is 6.1 mcf/d. Using the same ratio of emissions to production for the average national well would yield low production emissions rates of 0.24 mcf/d nationally and 0.06 mcf/d for Pennsylvania. On this basis the potential recovery would be 9 mcf/y for the national average low production well and 2.2 mcf/y for the Pennsylvania well. The gross and net cost effectiveness values would be \$222.89/mcf and \$221.22/mcf for the national wells and \$911.81/mcf and \$910.15/mcf for the Pennsylvania wells, respectively. Setting aside that most of the likely emissions would be from permitted storage tank vents, these assessments argue that the Optical Gas Imaging OGI LDAR approach is not cost effective.

#### Are there low-cost solutions available?

Operators conducting routine inspections using sight, sound and smell. OOOOa allows the use of a soap solution to confirm leak repairs (60.5397a(h)(3)(iii)(A)). This method, listed under Alternative Screening Procedures from Method 21, Section 8.3.3, is a cost-effective, efficient and acceptable way to confirm leak repairs.

<https://www.epa.gov/emc/method-21-volatile-organic-compound-leaks>

#### If a solution is high-cost, why is that the case?

The cost of leak detection depends on many variables and is difficult to generalize. However, the primary driver of cost effectiveness is the baseline emissions estimates and the number of leaks detected. When Colorado and EPA initially drafted their rules, they had very little data to estimate the number of leaks and the baseline fugitive emissions, so based on aEPA's1995 Protocol for Equipment Leak Emission Estimates, EPA and Colorado relied upon VOC emission factors in Table 2-4 of the 1995 EPA Leak Protocol. ([link](#)) Figures 5-16 through 5-34 of the 1995 EPA Leak Protocol demonstrate that the VOC emission factors within Table 2-4 correspond to between 1.6% and 2.5% of components that are assumed to be leaking. The lower value represents an assumed 10,000 ppm Method 12 leak definition and the higher value assumes a 500 ppm leak definition. NSPS OOOOa's leak definition is 500 ppm, which would correlate to the 2.5% component leak rate. In contrast, API surveyed its members and found an average initial leak incidence for all well sites was 0.4% of the components surveyed. ([link](#)) The 1995 EPA Leak Protocol contains an alternate set of VOC emission factors in Table 2-8, which allows for the incorporation of an actual % component leak rate that is based upon more recent data such as the API dataset. Establishing a more realistic baseline emission total using Table 2-8 will more accurately reflect the emissions benefit for a cost benefit analysis. Another key component to establishing an accurate and basin specific

baseline is to have an accurate and representative % VOC and an accurate and representative fugitive component count by basin.

Capital costs, personnel time, training, travel time to sites all make instrument-based programs high.

#### Are there additional technical analyses needed to refine benefits/costs estimates?

Continued piloting and testing of new technologies in field and controlled settings such as the studies conducted at Colorado State University. METEC<sup>52</sup> Colorado State University is a project in collaboration with US Department of Energy's ARPA-E and their methane initiatives. The goal of the METEC facility is to provide a location that models natural gas facilities, so that researchers can test methane sensing technologies and evaluate their performance. In order to evaluate the performance of each Methane Observation Networks with Innovative Technology to Obtain Reductions (MONITOR) technology to locate and quantify fugitive methane emissions, the MONITOR Field Test Site develops a representative test facility that simulates real-world natural gas operations—at the wellpad and further downstream. Specifically, the MONITOR Test Site supports the operation of a multi-user field test site for MONITOR performers to validate performance under realistic use-case scenarios—and meet the MONITOR program's required metrics related to localization, quantification, communications and cost. Data generated during the field tests demonstrates the performance capabilities of the technologies and could be used by the MONITOR performers to accelerate the commercialization and/or regulatory approval of their technologies.

The Stanford/EDF Mobile Monitoring Challenge also provides results from 10 vehicle, drone, and plane based leak detection technologies. In this test, 6 of the 10 technologies correctly detected 90% of the test scenarios. All technologies demonstrated site-level localization of leaks, while 6 of the 10 technologies could assign a leak to the specific piece of equipment in at least 50% of test scenarios. Even as this study provides the first independent verification of the performance of mobile technologies, it only represents the first step in the road to demonstrating that these technologies will provide emissions reductions that are equivalent to existing regulatory approaches. ([link](#))

To better understand cost effectiveness, the emissions benefits from these various tests should be considered.

## 3. IMPLEMENTATION

For each piece of equipment or process, please consider the following questions and add other relevant information. If relevant, please identify if the answers are different for large company and small company requirements or are different for well type or basin.

### **Implementation Feasibility:**

What is the feasibility of implementation (availability of required technology or contractors, potential permitting requirements, potential for innovation)?

Leak detection is feasible, and contractors are available, though may have to travel significant distances to visit sites.

<sup>52</sup> <https://energy.colostate.edu/metec/>

**FIGURE 7.** Typical One-Way Travel Distance Reported

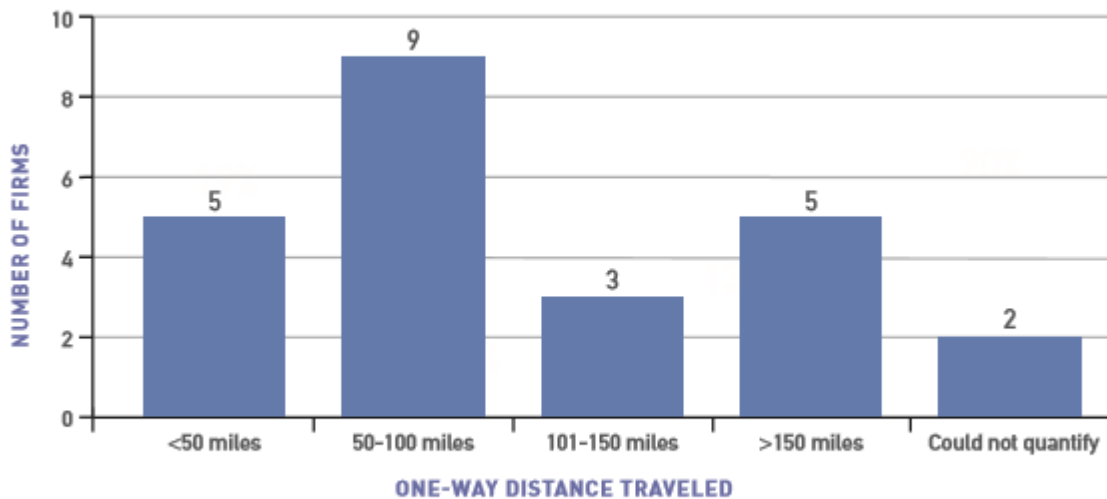

**SOURCE:** Industry Interviews

**NOTE:** Based on a sub-sample of 24 LDAR firms

[https://www.daturesearch.com/wp-content/uploads/Methane-Mitigation-Industry-Report\\_Final.pdf](https://www.daturesearch.com/wp-content/uploads/Methane-Mitigation-Industry-Report_Final.pdf)

What is the useful life of equipment?

N/A

What are the maintenance and repair requirements for equipment required for methane reduction?

Optical gas imagers generally need to be sent back to the manufacturer for calibration and testing on a regular basis. Sniffers need to be calibrated on a daily basis to ensure accurate ppm readings.

How would emissions be detected, reductions verified and reported?

Operators can report using EPA's leak/no leak emissions factors through existing reporting processes (GHGRP).

## 4. CHALLENGES AND OPPORTUNITIES TO ACHIEVE METHANE REDUCTION IN NEW MEXICO

For each piece of equipment or process, please consider the following questions and add other relevant information. If relevant, please identify if the answers are different for large company and small company requirements or are different for well type or basin.

What regulatory gaps exist for this equipment or process? Are there regulatory gaps filled by the proposed implementation?

Inspections are currently required for all gas plants (NSPS KKK) and for new and modified production facilities under OOOOa.

NM does not have its own LDAR requirements

Where do conflicting priorities exist between NMED, EMNRD, and NMSLO? Are there opportunities for coordination between these agencies?

None

Are there existing regulations related to methane that do not address the intended purpose? Identify any unintended barriers to methane reductions/capture that may hinder proposed processes.

In other states and with EPA, there is very limited ability to adopt new technologies. New Mexico has an opportunity to avoid the unintended consequence of requiring old technology by creating flexibility.

Other considerations or comments (e.g. particular design or technological challenges/opportunities, co-benefits, non-air environmental impacts, etc.):

None

DRAFT



## 5. LDAR PATH FORWARD<sup>53</sup>

	OPTIONS	DESCRIPTION AND LINK TO INFORMATION IF AVAILABLE. PLEASE LIST THE BENEFIT THAT COULD BE ACHIEVED THROUGH THIS OPTION AND ANY DRAWBACKS OR CHALLENGES TO IMPLEMENTATION	EFFECTIVENESS OF COST NOW (choose one)	REPORTING, MONITORING AND RECORDING OPTIONS, INCLUDING REMOTE DATA COLLECTION	IS THIS OPTION HELPFUL IN THE SAN JUAN BASIN, PERMIAN BASIN OR BOTH
2.1	Annual inspections for existing facilities, avoiding duplication with existing federal programs, such as the LDAR provisions of NSPS OOOOa and NSPS KKK. Low production wells (less than 15 BOEPD) should be excluded Wellhead only locations should not be included in the LDAR program due to very limited equipment on location, consistent with NSPS OOOOa. Facilities that do not require permits similarly have very limited equipment and should be exempt from a LDAR program. Facilities without	Reduce leaks where there will be the most emissions reduction benefit.	Medium	GHGRP reporting using leaker emission factor method	

<sup>53</sup> The format of the Path Forward table evolved over the course of the meetings as the group tried to identify the best method for capturing the most useful information. As a result, there is some variation in the table headers from topic to topic in the final consolidated report.

	controlled equipment would not benefit from an LDAR program as a low level of emissions will occur under allowable permit limits with or without an inspection program.				
	COMMENT		SUGGESTION TO MAKE THIS OPTION MORE WORKABLE:		
2.2	Quarterly LDAR	<p>Independent research across the United States has shown that emissions at oil and gas sites from leaks, broken or worn out equipment, and improper operations are substantial and greatly underestimated in inventories. Regular, quarterly LDAR is needed to mitigate these unnecessary and harmful emissions and can be implemented for a reasonable cost. A recent synthesis of the U.S. studies conducted over the past six years concluded that U.S. production emissions are 60% higher than inventories suggest.<sup>54</sup></p> <p>California Air Resources Board, 17 C.C.R. § 95669 (March 24, 2006), available at <a href="https://www.arb.ca.gov/cc/oil-gas/Oil%20and%20Gas%20Appx%20A%20Regulation%20Text.pdf">https://www.arb.ca.gov/cc/oil-gas/Oil%20and%20Gas%20Appx%20A%20Regulation%20Text.pdf</a>;</p> <p>Colorado Air Quality Control Commission, 5 C.C.R. 1001-9, CO Reg. 7, § XVII.F. (Feb. 24, 2014), available at <a href="https://drive.google.com/file/d/168v7vMsFJtS7D8BWlnMbaXWA6uZUlyj8/view">https://drive.google.com/file/d/168v7vMsFJtS7D8BWlnMbaXWA6uZUlyj8/view</a></p>	<p>LOW MODERATE HIGH</p>		

<sup>54</sup> Alvarez, et al., “Assessment of methane emissions from the U.S. oil and gas supply chain” Science, June 2018, <http://science.sciencemag.org/content/early/2018/06/20/science.aar7204.full>. Data for this study included measurement of emissions from over 400 individual well pads in six different US basins, validated against “top-down” airborne measurements of emissions from nine oil and gas producing basins. The authors of this synthesis study, as well as the underlying studies analyzed in the synthesis paper, include academics from twenty-five different research institutions. These scientists have concluded that the substantial extra emissions observed in these studies, compared to official inventories, likely arise from improper and abnormal operating conditions at the site level that are best addressed by frequent, if not continuous, inspections.

COMMENT		SUGGESTION TO MAKE THIS OPTION MORE WORKABLE:			
2.3	Include a robust alternative compliance pathway in rules that would allow operators to request approval to use an alternative leak detection technology or method to an IR camera or Method 21	Colorado: 5 C.C.R. 1009-1 § XII.L.8.a(ii)(I); CDPHE, Alternative AIMM Guidance and Procedures, p. 1 (May 31, 2018) (available at <a href="https://drive.google.com/file/d/1reFIFX_DVI_Wcu82853NNekmhjOtljui/view">https://drive.google.com/file/d/1reFIFX_DVI_Wcu82853NNekmhjOtljui/view</a> )	LOW MODERATE HIGH		
COMMENT		SUGGESTION TO MAKE THIS OPTION MORE WORKABLE:			
2.4	Use of emissions quantitation technology during inspections	Use of OGI with quantitation software would allow for simultaneous leak detection and emissions volume measurement	LOW MODERATE HIGH		
COMMENT		SUGGESTION TO MAKE THIS OPTION MORE WORKABLE:			

# SECTION 3, DEHYDRATION UNITS

Discussion for MAP members on September 13, 2019

---

NOTE: The focus of this report is processes, and the associated equipment, directly related to the release or capture of methane gas. We are not requesting information on processes/equipment that are not related to the release or capture of methane gas.

## 1. DESCRIPTION OF PROCESS AND EQUIPMENT

Provide a description of the processes and/or equipment used in oil and/or gas extraction for this topic. Note that this report template will be used for all topics of the MAP review and, thus, not all questions or information may be relevant for each topic. If information is not relevant, indicate N/A. Note any differences expected for differing well types, industry sector, or basin location.

### Technical description of the process or equipment:

Operators are often required to dehydrate natural gas streams that are saturated with water vapor to meet pipeline specifications. Water in natural gas pipelines can result in hydrates (solids) formation that obstruct or plug the pipe. Also, water vapor in a pipeline can cause corrosion. Commonly, operators use liquid desiccant dehydrators to remove water from natural gas to meet pipeline water content requirements, where the liquid desiccant most often utilized is triethylene glycol (TEG or 'glycol'). Glycol also will absorb volatile organic compounds (VOCs), some Hazardous Air Pollutants (HAPs) and methane in this process.

In the dehydration unit process, wet gas enters near the bottom of the glycol contactor tower (absorber) and comes into contact with lean glycol (water poor) in the contactor tower. In the glycol contactor tower, water in the natural gas is absorbed by the glycol circulating in the tower. This reduces water in the natural gas and the gas dew point is reduced. It is in this process that the glycol also absorbs methane, HAPs and VOCs. The dehydrated gas, referred to as dry gas, exits through the top of the glycol contactor tower. The glycol that absorbed the water is called rich glycol. The rich glycol exits from the bottom of the glycol contactor and flows to the regeneration system. The regeneration system typically includes a glycol flash tank (gas-condensate-glycol separator) and a reboiler. If a glycol flash tank is not installed, the rich glycol is routed directly to the reboiler.

The glycol flash tank (gas-condensate-glycol separator) serves as a separator to recover entrained gas and condensate from the glycol. It also reduces the pressure of the rich glycol prior to entering the reboiler. After the flash tank, the glycol enters the reboiler. Here, the glycol is heated to boil off water from the glycol to produce lean glycol. The lean glycol is cooled using a heat exchanger and pumped back to the glycol contactor tower to repeat the cycle. It is within this process that methane, HAPs and VOCs are boiled off and separated from the glycol.

Typical dry gas pipeline requirements range from 4 to 7 lbs water per mmscf of natural gas.

A glycol circulation pump is used to circulate glycol through the system. There are many varieties of pumps used including positive displacement (gas-injection) pumps, other pneumatic pumps and electric reciprocating and centrifugal pumps. Larger glycol dehydrators often use electric motor-driven pumps.

The reboiler uses a still column (reflux condenser coil) to separate water from the glycol. The still column's vent gas will contain water vapor and VOCs. The heat from the reboiler is generated by burning natural gas.

Although glycol dehydrators are most common, solid desiccant dehydration is another process which can be used. Solid desiccants use salt crystals with large surface areas to attract water molecules. Refrigeration is another method of dehydration. This involves cooling gas to a temperature below the condensation point of water.

Provide the segment(s) of the industry that the equipment or process is found:

The equipment/process is largely found in the oil and gas midstream gathering segment of industry. In addition, the equipment/process is commonly found in the upstream and natural gas processing sector.

Describe how the equipment or process is used:

Dehydration units are used to remove water from natural gas.

Provide the common process configurations that use this equipment or process:

Below is a schematic of the common process configuration of this process. There are slight variations of the configuration that are commonly utilized. For example, some configurations exclude the flash tank so that all flashing occurs in the regenerator. There are many variations regarding control of the two primary emission points (the regenerator vent and the flash tank vent) discussed below.

## Glycol Dehydration Unit

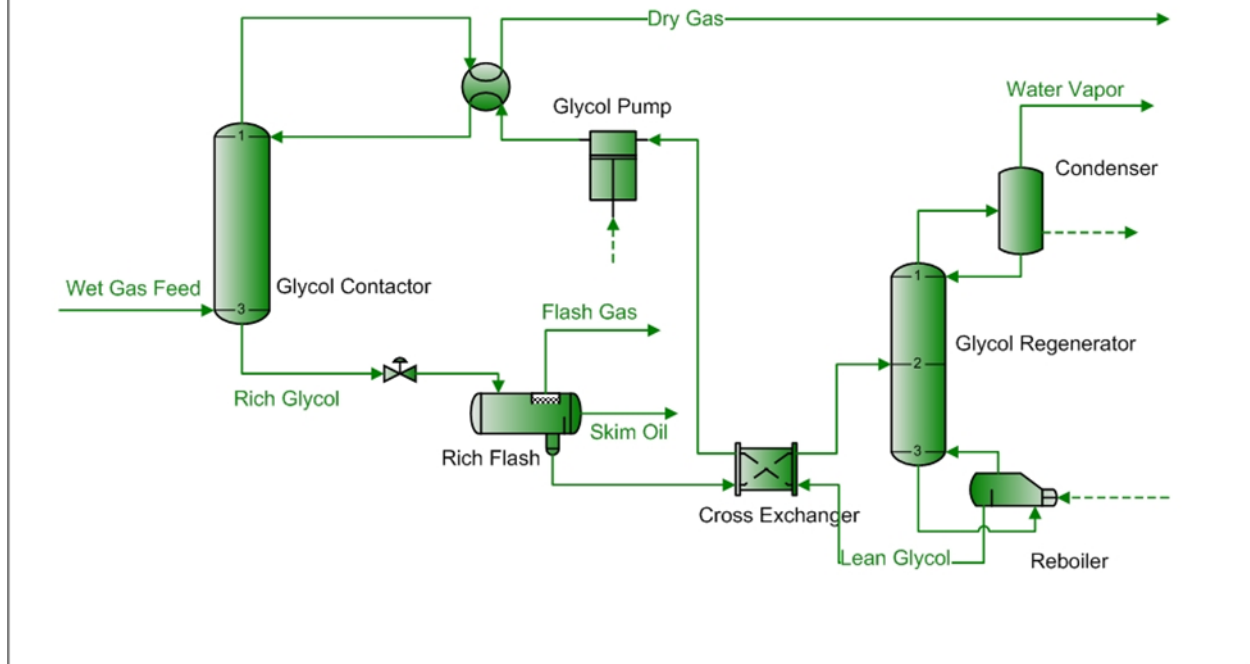

The emission streams from the flash tank (labeled flash gas on the schematic) and the condenser (labeled water vapor on the schematic) are typically controlled by one of several methods, including combustion in the reboiler firebox or by a flare and captured by a VRU, among others discussed in Section 2.

### What is the distribution of the equipment or process across business segments?

This equipment is largely found in the oil and gas midstream gathering segment of industry. In addition, the equipment/process is commonly found in the upstream and natural gas processing segment.

### How has this equipment or process evolved over time?

This equipment or process has not changed much over time. The development of the cryogenic gas plant (early '70s) necessitated the need to remove almost all water from the gas stream in order to prevent freezing in the cryogenic portion of the plant.

## 2. INFORMATION ON EQUIPMENT OR PROCESS COSTS, SOURCES OF METHANE EMISSIONS, AND REDUCTION OR CONTROL OPTIONS

Identify the capital and operating costs for the equipment or the process. Identify how methane is emitted or could be leaked into the air. Please **prioritize** the list to identify first the largest source of methane from the process or equipment and where there is **potential** for the greatest reduction of methane emissions. Note any differences expected for differing well types, industry sector, or basin location.

### **Sources of Methane:**

Provide an overview of the sources of methane from this equipment or process:

Natural gas streams contain varying amounts of methane, VOCs and hazardous air pollutants (HAP). HAPs in natural gas include benzene, toluene, ethylbenzene, xylenes, (BTEX), n-hexane and 2,2,4-trimethylpentane. These HAPs are slightly soluble in the TEG used and as a result, HAPs are absorbed in the glycol contactor. Also, methane and VOCs (other than BTEX) will be entrained in the rich glycol due to the high operating pressure of the glycol contactor (600 to >1000 psig).

Flash gas liberated from the flash tank (located between glycol contactor and reboiler) will be natural gas that is mostly methane and some VOCs and small amounts of BTEX.

Regeneration of the rich glycol in the reboiler results in emissions of methane, VOCs and HAPs to be released with the water vapor exiting the still column vent.

The sources of and types of air pollution from a TEG glycol dehydrator include the following:

1. Still Column (Regenerator) Vent – water, methane, VOCs, HAPs
2. Flash Tank – primarily natural gas similar to fuel gas (primarily methane and some VOC and BTEX)
3. Reboiler – combustion emissions from the reboiler burning natural gas.

Methane is absorbed into the glycol in the absorber tower. The methane will flash off in the flash gas separator, if installed. Flash gas separators are typically controlled and not vented to the atmosphere. If a flash gas separator is not installed, the methane will be removed from the glycol in the regenerator and vented through the still vent stack

### New Wells:

Dehydration units are typically located at gathering compressor stations but can be located at new well sites.

### Existing Wells:

Dehydrations units are typically located at gathering compressor stations. However, there are instances in which a small dehydration unit may be placed at an existing well site.

### How are the emissions calculated for this equipment or process?

Emission rate calculations involve using a process simulator to estimate emissions. Simulators typically used include GRI-GLYCalc, PROMAX and HYSYS. Manufacturer's data and state/federal guidance are utilized to determine the control efficiencies of the various types of controls.

### What data is available to quantify emissions/waste for this equipment or process?

<https://www.epa.gov/ghgreporting>

Dehydration unit emissions range from less than 1% to 5% of a site's emissions. Specifically, within processing facilities, dehydration unit emissions represent less than 1% of processing facility emissions.

### What are the data gaps in quantifying emissions/waste for this equipment?

There are no gaps identified for emissions of glycol dehydration units as emissions are quantified in air permits and reporting to NMED. The NMED AQB NSR and TV document on glycol dehydrators (May 23, 2011) notes that there is a 'lack of experience with field tests on glycol dehydrators'. As above reference provided in emissions calculations, NMED AQB requires proven process simulator modeling. Data gaps for this source category include lack of measurement data and the reporting threshold for Subpart W of the Greenhouse Gas Reporting Program.

## **Economic Description of the Process or Equipment:**

### What is the per unit cost of the equipment or the costs associated with the process?

Costs vary widely based upon size.

Table 1 of the "Cost-Effectiveness of Comprehensive Oil and Gas Emissions Reduction Rules in New Mexico" lists unit costs for VRU abatement technology as \$4.18 per mcf of reduced methane (\$217.36 per tonne).<sup>55</sup>

### What are the annualized operating costs for the equipment or costs associated with the process?

Costs vary widely based upon size.

### If the equipment or process is powered, what are the costs?

Costs vary widely based upon size.

---

<sup>55</sup> "Cost-Effectiveness of Comprehensive Oil and Gas Emissions Reduction Rules in New Mexico," Erin Camp, PhD, Nate Garner, Asa Hopkins, PhD, Synapse Energy Economics, Inc., September 13, 2019, page 9, Table 1, <http://blogs.edf.org/energyexchange/files/2019/09/Synapse-Methane-Cost-Benefit-Report.pdf>.



What are the maintenance and repair costs for existing or new equipment?

Costs vary widely based upon size.

**Existing Reduction Strategies:**

How has industry reduced emissions/waste from this equipment or process historically?

Glycol dehydration units are already regulated under 40 CFR 63, Subpart HH. While this regulation covers benzene emissions, the controls placed on dehydration units will also reduce methane emissions. The primary driver for emissions reductions has been to meet this requirement which, in turn, captures and controls methane.

The GCP asks to control the glycol circulation rate, and as control has options of

1. installing a BTEX condenser, which is a common control for the still column
2. route flash tank emissions to a combustion device
3. route flash tank emissions to a closed loop system
4. VRU for the still vent and/or flash tank
5. Other control devices such as flare or thermal oxidizer
6. Install electric or instrument-air recirculation pumps (using onsite electricity, solar, etc.).

NSPS Subpart HH

The control device used to reduce HAP emissions in accordance with the standards of this subpart shall be one of the control devices.

1. An enclosed combustion device (e.g., thermal vapor incinerator, catalytic vapor incinerator, boiler, or process heater) to control TOC or total HAP in the gases vented to the device by 95.0 percent by weight or greater
2. A vapor recovery device (e.g., carbon adsorption system or condenser)
3. A flare

In addition to the federal rules, the states of Colorado, Wyoming and Pennsylvania regulate emissions from dehydration units. Citations to rules are provided below.

Note: NSPS Subpart HH does not regulate for methane.

New Wells:

N/A

Existing Wells:

N/A

How have the emission/waste reductions been measured?

Dehydration emissions are included during the permitting process and simulated prior to the development of a facility to ensure emissions meeting required permitted limits. Additionally, dehydration methane and GHG emissions are reported under the GHG Reporting Rule.

How have states and the federal government reduced emissions/waste from this equipment or process historically? In addition, please identify voluntary reductions achieved whether or not they were in response to a regulatory action/requirement.

Glycol dehydration units have been regulated under 40 CFR 63, Subpart HH. While this regulation covers benzene emissions, the controls placed on dehydration units also reduce methane emissions. The primary driver for emissions reductions has been to meet this requirement which, in turn, captures and controls methane. The control device used to reduce HAP emissions in accordance with the standards of this subpart include enclosed combustion devices, vapor recovery devices and flares. This regulation was updated as recently as 2012 to include small dehydrators.

These regulations typically require the units to control still column vent and flash tank emissions and may require that the unit operate below a calculated glycol circulation rate. EPA regulations affecting glycol dehydration units include the hazardous air pollutant rules (HAPs) in 40 CFR 63, Subpart HH— National Emission Standards for Hazardous Air Pollutants from Oil and Natural Gas Production Facilities. This regulation impacts onshore oil and gas production facilities glycol dehydrators and some oil storage tanks. This rule regulates Major HAP sources as well as glycol units at small sources, called Area Sources. The requirements for area sources are less robust than those for major sources.

NESHAP Subpart HH for Oil and Natural Gas Production Facilities distinguishes between “Large” and “Small” glycol dehydration units. Large units are defined as units that process >85,000 standard cubic meters per day and emit greater than 1 tpy benzene. Both new and existing small glycol dehydrators at major sources must meet the unit-specific BTEX (benzene, toluene, ethylbenzene and xylene) limit for emissions that is based on the unit’s natural gas throughput and gas composition. Newly constructed “small” glycol dehydrators (dehy), built after August 23, 2011, must meet the exemption requirement to demonstrate the gas throughput is less than 85,000 standard cubic meters per day or emit less than 1 tpy benzene. To ensure compliance, this exemption demonstration should be reviewed and documented on an annual basis. If the small dehy does not meet the emission control exemption, the unit must meet the control standards upon startup. Existing small glycol dehydrators were required to be in compliance by October 15, 2015.

In Colorado, state-wide rules require that all existing glycol natural gas dehydrators with uncontrolled actual VOC emissions of 6 tpy or greater be controlled with air pollution control equipment achieving at least a 95%

reduction. The rules also require that all new glycol natural gas dehydrators with uncontrolled actual VOC emissions of 2 tpy or greater be controlled with air pollution control equipment achieving at least 95% reduction. If a combustion device is used, it must have a design destruction efficiency of at least 98%, with few exceptions.

(Colorado Air Quality Control Commission, 5 C.C.R. 1001-9, CO Reg. 7, XVII.D.3. (Feb. 24, 2014)). The Colorado Oil and Gas Conservation Commission also has a rule requiring all glycol dehydrators with uncontrolled actual emissions of VOC of 5 tpy or greater, located within 1,320 feet of a Building Unit, or a Designated Outside Activity Area use an emission control device capable of achieving 90% control efficiency of VOC. (COGCC Rule 805b(2)B). These rules apply to production facilities, compressor stations and gas processing plants.

At existing facilities in Wyoming, when a combustion unit is required for control of dehydration unit emissions, all non-condensable still vent vapors must be collected and routed to a combustion unit for at least 98% control of VOC and HAP emissions. All glycol flash separator vapors must be collected and routed to the combustion unit for at least 98% control of VOC and HAP emissions and/or used as fuel for process equipment burners. For new PAD facilities in Wyoming, upon first day of production, all dehydration unit VOC and HAP emissions must be controlled by at least 98%. After one year, combustion units used to achieve the 98% control may be removed if total potential VOC and HAP emissions from all units are less than 4 tpy and all units are equipped with still vent condensers. At new single-well facilities, within 60 days of the first day of production, if total potential uncontrolled VOC and HAP emissions from all units are greater than or equal to 6 tpy (4 tpy in the UGRB), emissions from all units must be controlled by at least 98%. After one year, combustion units used to achieve the 98% control may be removed if the total potential VOC and HAP emissions from all units are less than 4 tpy and all units are equipped with still vent condensers. Removal of controls is not allowed in the Jonah Pinedale Anticline Development Area. WDEQ, Air Quality Division Rules, Chapter 8, section 6(d)(i) (May 19, 2015), WDEQ, Oil and Gas Production Facilities Chapter 6, Section 2 Permitting Guidance (May 2016). These rules apply to production facilities.

In Pennsylvania, for new glycol dehydrators, whose uncontrolled emissions are greater than or equal to the methane de minimis level of 200 tpy, VOC de minimis level of 2.7 tpy, single HAP limit of 0.5 tpy, or combined HAP limit of 1 tpy, emission controls must be installed and emissions must be reduced by at least 98%. Existing glycol dehydrators installed prior to February 2, 2013, which have a total uncontrolled PTE of VOC in excess of 10 tpy, must be controlled by at least 85% with a condenser, enclosed flare, or other air cleaning device approved by the Department. Existing glycol dehydrators installed on or after February 2, 2013, but before August 8, 2018 at a natural gas compression station or processing plant, with total uncontrolled PTE of VOC in excess of 5 tpy, must be controlled by at least 95% with a condenser, enclosed flare or other air cleaning device approved by the Department. Existing glycol dehydrators installed on or after August 10, 2013, but before August 8, 2018 at an unconventional

natural gas well site or remote pigging station, with a total uncontrolled VOC emission rate greater than or equal to 2.7 tpy, an uncontrolled single HAP emission rate greater than or equal to 0.5 tpy, or a total HAP emission rate greater than or equal to 1.0 tpy, must be controlled by at least 95%. (PA DEP, Bureau of Air Quality, Technical Support Document, June 2018).

In Ohio, General Permits for Natural Gas Compressor Stations and Similar Facilities mandate a 0.42 ton per month of VOC limit for dehydrators with throughput less than 90 MMscf/day and a 0.70 limit for dehydrators with greater than 90 but less than 150 MM scf/d throughput. (Ohio General Permits, <https://www.epa.ohio.gov/dapc/genpermit/ngcs>).

The NMED General Construction Permit (GCP) requires controls reducing VOCs and HAPs, which also reduce methane. Moreover, the NMED permits require conditions to ensure that the controls remain effective. For example, the GCP Oil and Gas requires inspection of controls, periodic gas sampling of the gas routed to the glycol dehydration unit, monitoring of glycol pump rates and other requirements. The requirements (conditions) are intended to ensure the emissions from glycol dehydrators remain below permit allowances.

What are examples of process changes/modifications that reduce or eliminate emissions/waste from this equipment or process?

The addition of the controls and/or practices outlined above can reduce methane emissions from glycol dehydrators. These strategies are widely utilized and required by permit.

### Technology Alternatives:

List of technology alternatives with link to information or contact information for the company/developers.

Name/Description of Technology	Link (and contact info for company if available)	Availability	Feasibility	Cost Range (choose one)
<b>Use Zero Emissions Dehydrators</b> These dehydrators combine flash tanks, electric pumps, and electric control valves to virtually eliminate emissions.	<a href="https://www.epa.gov/sites/production/files/2016-06/documents/zeroemissionsdehy.pdf">https://www.epa.gov/sites/production/files/2016-06/documents/zeroemissionsdehy.pdf</a>	In use	No feasibility limitations. Combines a set of widespread technologies—flash tanks, electric pumps, and electric control valves.	Low – Medium <b>High</b>
<b>Use solid desiccant dehydrators</b>	<a href="https://www.epa.gov/sites/production/files/2016-06/documents/ll_desde.pdf">https://www.epa.gov/sites/production/files/2016-06/documents/ll_desde.pdf</a>	In use	Not viable when gas temperatures	Low <b>Medium</b> High

<p>Use salt crystals with large surface areas to attract water molecules—are used in the oil and gas industry. These dehydrators do not require an external power supply, have no moving parts, and are capable of reducing emissions by 99 percent.</p>			<p>are high. Especially difficult in remote areas to properly maintain can lead to increased methane emissions.</p>	
<p><b>Optimize glycol circulation.</b> The manner in which a glycol dehydrator is used can also impact emission rates. For example, both the efficiency and emission rate of a glycol dehydrator are directly proportional to the rate at which gas is circulated. In certain cases, operators may be able to reduce circulation rates to reduce emissions, while still removing enough water from the gas to meet sales specifications.</p>	<p><a href="https://www.epa.gov/sites/production/files/2016-06/documents/II_flashtanks3.pdf">https://www.epa.gov/sites/production/files/2016-06/documents/II_flashtanks3.pdf</a></p>	<p>In use</p>	<p>No feasibility limitations, however, many operators may already be operating at optimal circulation rates.</p>	<p><b>Low</b> <b>Medium</b> <b>High</b></p>
<p><b>Install flash tank separator.</b> A flash tank separator brings the rich glycol to a lower pressure at which hydrocarbons will evaporate but water will remain in solution with the glycol. The flash tank captures approximately 90 percent of the methane</p>	<p><a href="https://www.epa.gov/sites/production/files/2016-06/documents/II_flashtanks3.pdf">https://www.epa.gov/sites/production/files/2016-06/documents/II_flashtanks3.pdf</a></p>	<p>In use</p>	<p>No feasibility limitations.</p>	<p><b>Low</b> <b>Medium</b> <b>High</b></p>

<p>and 10 to 40 percent of the VOCs entrained by the glycol. The captured gas is then routed to a fuel line, a compression suction, or a flare.</p>				
<p><b>Use Electric Pumps Instead of Pneumatic Pumps.</b> A pneumatic pump must circulate significantly more gas, because gas pressure drives the circulation process. Pneumatic pumps may also leak rich (wet) glycol into the lean (dry) glycol, which decreases the efficiency of the system and requires greater circulation—leading to greater emissions.</p>	<p><a href="https://www.epa.gov/sites/production/files/2016-06/documents/ll_glycol_pumps3.pdf">https://www.epa.gov/sites/production/files/2016-06/documents/ll_glycol_pumps3.pdf</a></p>	<p>In use</p>	<p>Requires electricity</p>	<p>Low <b>Medium</b> High</p>
<p><b>Reroute Glycol Skimmer Gas.</b> In the glycol dehydration process, rich glycol is circulated through a regenerator where the liquid is heated and water and hydrocarbons are vaporized and vented to the atmosphere. Some glycol dehydrators have glycol vent condensers and condensate separators to recover natural gas liquids and reduce VOC and HAP emissions. The condensate gas can be rerouted to the reboiler or other low-pressure</p>	<p><a href="https://www.epa.gov/sites/production/files/2016-06/documents/rerouteglycolskimmer.pdf">https://www.epa.gov/sites/production/files/2016-06/documents/rerouteglycolskimmer.pdf</a></p>	<p>In use</p>		<p>Low <b>Medium</b> High</p>

fuel gas system for fuel use.				
<p><b>Route Recovered Gas to Vapor Recovery Unit.</b>  <i>Rather than venting gas that evaporates from the rich glycol in the flash tank separator, some operators have piped this gas to a vapor recovery unit, where it can be put to beneficial use.</i></p>	<p><a href="https://www.epa.gov/sites/production/files/2016-06/documents/pipeglycoldehydratorvru.pdf">https://www.epa.gov/sites/production/files/2016-06/documents/pipeglycoldehydratorvru.pdf</a></p> <p><i>California includes the following language regarding low-NOx VRU: If the vapor control device is to be installed in a region classified as non-attainment with, or which has not been classified as in attainment of, all state and federal ambient air quality standards, the owner or operator must install one of the following devices that meets all applicable federal, state, and local air district requirements:</i></p> <p><i>(A) A non-destructive vapor control device that achieves at least 95 percent vapor control efficiency of total emissions and does not result in emissions of nitrogen oxides (NOx); or,</i></p> <p><i>(B) A vapor control device that achieves at least 95 percent vapor control efficiency of total emissions and does not generate more than 15 parts per million volume (ppmv) NOx when measured at 3 percent oxygen and does not require the use of supplemental fuel gas, other than gas required for a pilot burner, to operate.</i></p> <p>Source:  <a href="https://ww3.arb.ca.gov/regact/2016/oilandgas2016/ogfro.pdf">https://ww3.arb.ca.gov/regact/2016/oilandgas2016/ogfro.pdf</a></p> <p>Example:  <a href="http://www.aereon.com/enclosed-combustion-systems/certified-ultra-low-emissions-burner-ceb">http://www.aereon.com/enclosed-combustion-systems/certified-ultra-low-emissions-burner-ceb</a></p>	In use		<p>Low  <b>Medium</b>  High</p>

What technology alternatives exist to reduce or detect emissions? Please list all alternatives identified along with contact information for further investigation of this technology or process.

No new controls are necessary due to current control mechanisms and efficiency of process. The cost to achieve additional reductions would be high due to glycol dehydrators already being heavily regulated and there being little opportunity to make further reductions.

Various states identified above have determined that there is a need for state requirements in addition to the federal NESHAP requirements. The NESHAP MACT requirements apply only in certain circumstances, e.g., at major sources and the NESHAPs require less-protective requirements for dehydration units located at area sources. State requirements apply at minor sources and to dehydration units located at production facilities with emissions that may not trigger the application of the NESHAP requirements.

What are the pros and cons of the alternatives?

This is discussed above in the table. Many of them are already in use per best practice and regulation.

What is needed and available for new wells?

Discussed above in table.

See WY, CO, and PA requirements.

What is needed and available for existing wells?

Discussed above in table.

See WY and CO requirements

What technology alternatives exist for this equipment or process itself?

Discussed above in table

What are the pros and cons of the alternatives?

Discussed above in table.

### **Costs of Methane Reductions:**

What is the cost to achieve methane emission reductions?

No new controls are necessary due to current control mechanisms and efficiency of process.

ICF found that replacing positive displacement pumps with electric pumps results in overall savings of \$4.17/Mcf of methane reduced. (Source: ICF 2014, [https://www.edf.org/sites/default/files/methane\\_cost\\_curve\\_report.pdf](https://www.edf.org/sites/default/files/methane_cost_curve_report.pdf)) Gas price at which this savings occurs is unknown.

What would be the implementation cost?

For new wells?



N/A

For existing wells?

N/A

Are there low-cost solutions available?

N/A

If a solution is high-cost, why is that the case?

N/A

Are there additional technical analyses needed to refine benefits/costs estimates?

N/A

### 3. IMPLEMENTATION

For each piece of equipment or process, please consider the following questions and add other relevant information. If relevant, please identify if the answers are different for large company and small company requirements or are different for well type or basin.

#### **Implementation Feasibility:**

What is the feasibility of implementation (availability of required technology or contractors, potential permitting requirements, potential for innovation)?

N/A

What is the useful life of equipment?

Standard life of control equipment

What are the maintenance and repair requirements for equipment required for methane reduction?

Discussed in table

How would emissions be detected, reductions verified and reported?

Most dehydration units are covered in the GHGRP.

### 4. CHALLENGES AND OPPORTUNITIES TO ACHIEVE METHANE REDUCTION IN NEW MEXICO

For each piece of equipment or process, please consider the following questions and add other relevant information. If relevant, please identify if the answers are different for large company and small company requirements or are different for well type or basin.

What regulatory gaps exist for this equipment or process? Are there regulatory gaps filled by the proposed implementation?

None.

As noted above, the NESHAPs have limited applicability to major sources and large dehydration units. There is a gap for the state to fill with respect to controlling minor source emissions and emissions from smaller dehydration units located at major sources.

Where do conflicting priorities exist between NMED, EMNRD, and NMSLO? Are there opportunities for coordination between these agencies?

None

Are there existing regulations related to methane that do not address the intended purpose? Identify any unintended barriers to methane reductions/capture that may hinder proposed processes.

No

Other considerations or comments (e.g. particular design or technological challenges/opportunities, co-benefits, non-air environmental impacts, etc?):

None

## 5. DEHYDRATORS - PATH FORWARD<sup>56</sup>

	OPTIONS	DESCRIPTION AND LINK TO INFORMATION IF AVAILABLE. PLEASE LIST THE BENEFIT THAT COULD BE ACHIEVED THROUGH THIS OPTION AND ANY DRAWBACKS OR CHALLENGES TO IMPLEMENTATION	EMISSIONS REDUCTIONS ARE EASY TO ACHIEVE AND ARE COST EFFECTIVE  1 = EASY 5 = HARD	REPORTING, MONITORING AND RECORDING OPTIONS, INCLUDING REMOTE DATA COLLECTION	IS THIS OPTION HELPFUL IN THE SAN JUAN BASIN, PERMIAN BASIN OR BOTH
3.1	In general, no new controls are necessary for this process due to current control mechanisms		1 2 3 4 5	Covered in NMED permit conditions	San Juan  Permian  Both
COMMENT			SUGGESTION TO MAKE THIS OPTION MORE WORKABLE:		
3.2	Require use of zero emissions dehydrators. [page 76]	This option is not available where there is no line power  <a href="https://www.epa.gov/sites/production/files/2016-06/documents/zeroemissionsdehy.pdf">https://www.epa.gov/sites/production/files/2016-06/documents/zeroemissionsdehy.pdf</a>	1 2 3 4 5	Covered in NMED permit conditions	San Juan  Permian  Both
COMMENT			SUGGESTION TO MAKE THIS OPTION MORE WORKABLE:		
3.3	Require use of flash tanks, conversion to electric pumps and optimization of circulation rate. [page 76]	Electric pumps require presence of electricity.  <a href="https://www.epa.gov/sites/production/files/2016-06/documents/ll_flashtanks3.pdf">https://www.epa.gov/sites/production/files/2016-06/documents/ll_flashtanks3.pdf</a>	1 2 3 4 5	Covered in NMED permit conditions	San Juan  Permian  Both
COMMENT			SUGGESTION TO MAKE THIS OPTION MORE WORKABLE:		

<sup>56</sup> The format of the Path Forward table evolved over the course of the meetings as the group tried to identify the best method for capturing the most useful information. As a result, there is some variation in the table headers from topic to topic in the final consolidated report.

# SECTION 4, COMPRESSORS AND ENGINES

Discussion for MAP members on September 26, 2019

---

NOTE: The focus of this report is processes, and the associated equipment, directly related to the release or capture of methane gas. We are not requesting information on processes/equipment that are not related to the release or capture of methane gas.

## 1. DESCRIPTION OF PROCESS AND EQUIPMENT

Provide a description of the processes and/or equipment used in oil and/or gas extraction for this topic. Note that this report template will be used for all topics of the MAP review and, thus, not all questions or information may be relevant for each topic. If information is not relevant, indicate N/A. Note any differences expected for differing well types, industry sector, or basin location.

### Technical description of the process or equipment:

One of the most common processes in the natural gas sector is compression. Compressors are mechanical devices that increase the pressure of natural gas to allow the natural gas to move through the natural gas value chain. Compressors are also used within processes at natural gas processing facilities and at oil and gas production facilities to enable production. In the oil and natural gas sector, the most prevalent types of compressors are reciprocating and centrifugal compressors. The choice between a reciprocating and centrifugal compressor is always a case-by-case determination and depends on a variety of operating conditions, such as required discharge pressure, gas volume and temperature, efficiency and cost.

**Reciprocating compressor** increase the pressure of a gas by positive displacement. Natural gas enters the compression cylinder through the suction manifold, where it is compressed by a piston driven in a reciprocating motion by the crankshaft. See diagram below.

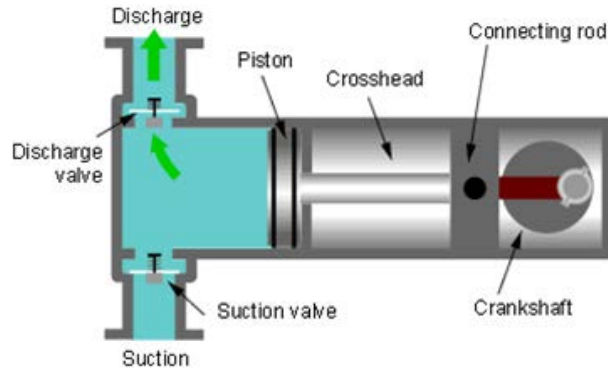

**Centrifugal compressor** increases pressure of a gas by drawing in low pressure natural gas through the suction port and discharging significantly higher pressure natural gas by means of mechanical rotating vanes or impellers. See Diagram below.

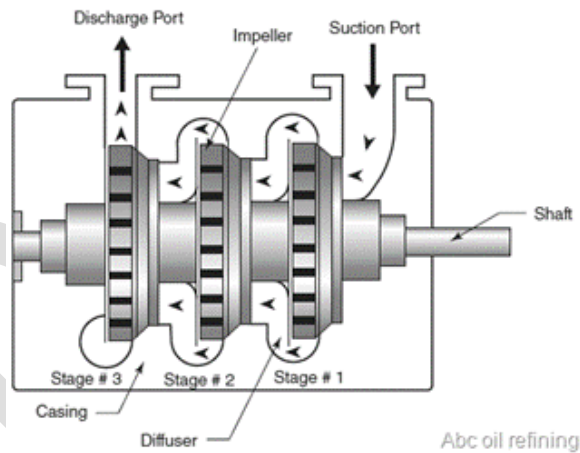

Compressors are paired with a driver. In the oil and natural gas sector, compressors are commonly powered by gas fired reciprocating internal combustion engines (RICE) for reciprocating compressors and gas fired combustion turbines for centrifugal compressors. In some cases, compressors may be paired with electrical motors rather than gas fired RICE or turbines.

**Gas fired reciprocating internal combustion engines** use pistons that alternatively move back and forth to convert pressure into rotating motion, which drives the crankshaft of the compressor. These are similar to the engines in most cars, with the exception that vehicles typically use gasoline as fuel.

### Reciprocating Compressor and RICE Engine

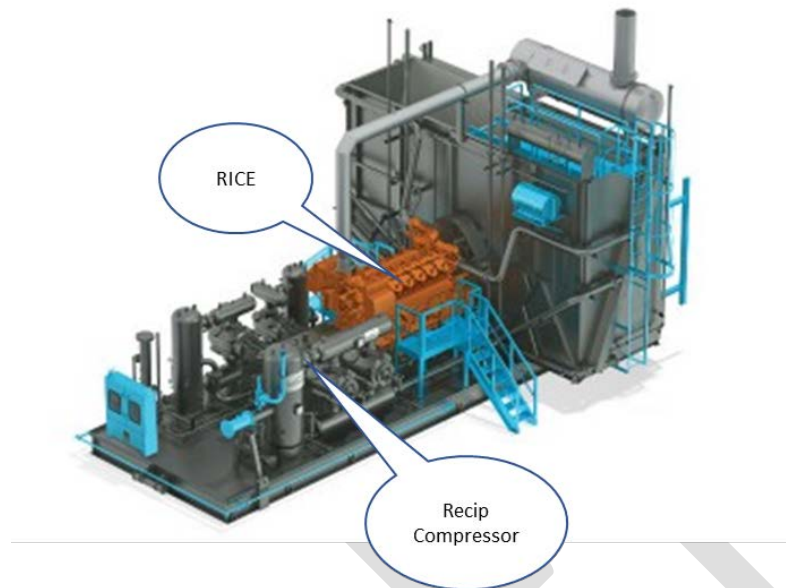

**Gas fired combustion turbines** heat a mixture of air and fuel at very high temperatures resulting in combustion of the gases, causing the turbine blades to spin at a very high speed, which drives the shaft of the centrifugal compressor. These are similar to the engines on a jet plane.

### Centrifugal Compressor and Combustion Turbine

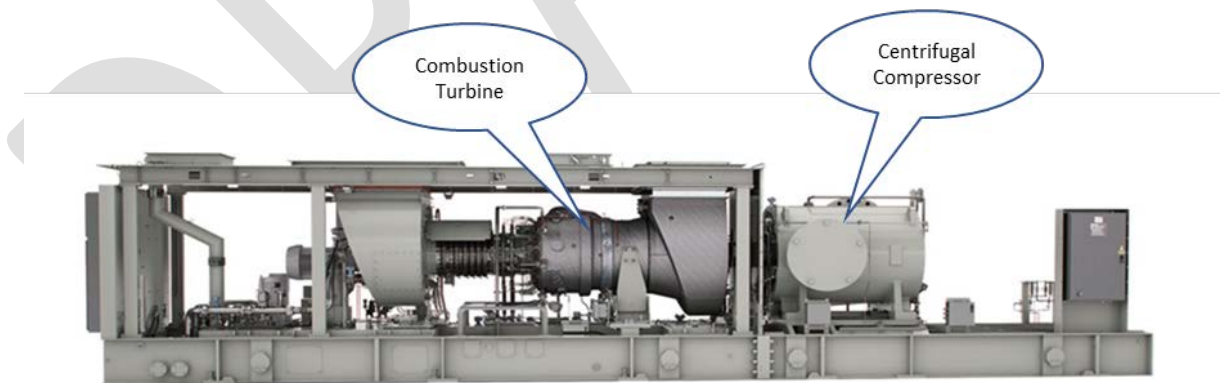

Provide the segment(s) of the industry that the equipment or process is found:

Production, gathering, processing, transmission, storage.

Describe how the equipment or process is used:

This link to the [EPA GHG Reporting Program](#), includes a description of the oil and gas value chain and identifies some of the locations where compression occurs.

To produce oil and natural gas and keep natural gas pressures at the level required to move gas from the wellhead to the consumer, compressors and the associated driver are found at multiple locations in the natural gas value chain, including:

- Oil and gas production operations for enhanced oil recovery, maintaining reservoir pressures, gas lift, gas reinjection, wellhead compression of natural gas, and capturing tank vapors for recovery (vapor recovery unit).
- Gas gathering compressor stations to move raw natural gas from the wellhead to natural gas processing plants
- Moving gas into and out of natural gas processing plants and within the natural gas processing plant to pressurize process gasses, for example to increase the pressure of gasses used in the refrigeration or cryogenic processes at a natural gas processing facility
- Downstream of the natural gas processing plant in the gas transmission sector to move natural gas long distances in large diameter pipelines to
  - natural gas storage facilities
  - natural gas distribution systems for delivery to end users
  - directly to large industrial, commercial, or power generation customers
- Moving natural gas into and out of natural gas storage facilities

In addition to driving compressors, engines may also be used as the driver for power generators that provide electrical power to sites that are not connected to the commercial electrical grid or may be used as backup power supply in case of a power outage. Engines are also used to drive pumpjacks in the oil production sector. Pumpjacks are used to mechanically lift liquid out of the well if bottom hole pressure is not high enough to allow liquid to flow to the surface.

Provide the common process configurations that use this equipment or process:

A diagram of the configuration of a typical natural gas compressor station (from enbridge.com) is provided below. This configuration is similar for gas gathering and gas transmission compressor stations. The configuration of compressors at gas processing facilities is similar, but perhaps more complex. At gas processing plants, compression can take place at the front end of the plant (inlet gas compression), as the processed natural gas exits the plant (residue compression), or within the process to compress refrigeration gases.

## 2. INFORMATION ON EQUIPMENT OR PROCESS COSTS, SOURCES OF METHANE EMISSIONS, AND REDUCTION OR CONTROL OPTIONS

Identify the capital and operating costs for the equipment or the process. Identify how methane is emitted or could be leaked into the air. Please **prioritize** the list to identify first the largest source of methane from the process or equipment and where there is **potential** for the greatest reduction of methane emissions. Note any differences expected for differing well types, industry sector, or basin location.

### Sources of Methane:

Provide an overview of the sources of methane from this equipment or process:

#### Compressors

The primary source of methane emissions from compressors are from seals around the piston rod of a reciprocating compressor and around the spinning shaft of a centrifugal compressor. There are two types of seals for centrifugal compressors, dry seals and wet seals. In all cases the seals prevent natural gas from exiting the compression chambers and entering the atmosphere. The following link to a paper published by USEPA Office of Air Quality Planning and Standards (OAQPS) titled [“Oil and Natural Gas Sector Compressors, Report of oil and Natural Gas Sector Compressors Review Panel, April 2014”](#), provides a good description of the seals systems in both reciprocating compressors (see top diagram below and section 2.1 of the EPA paper) and centrifugal compressors (see bottom diagrams below and section 2.2 of the EPA paper).

#### Rod Packing Seal System in Reciprocating Compressor

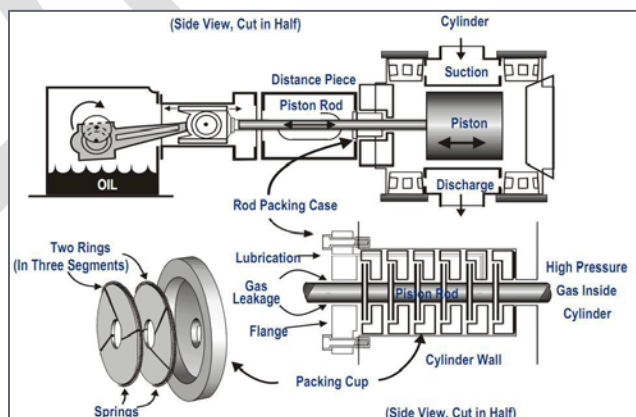



### Wet Seal System in Centrifugal Compressor

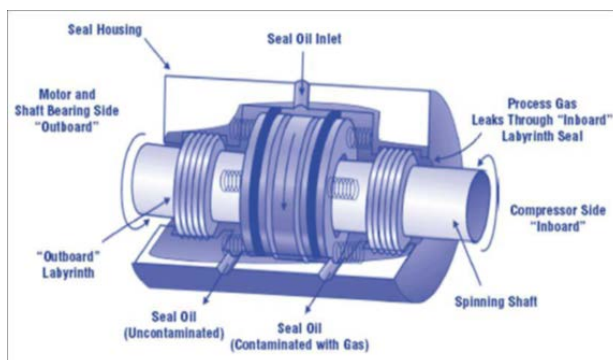

### Dry Seal System in Centrifugal Compressor

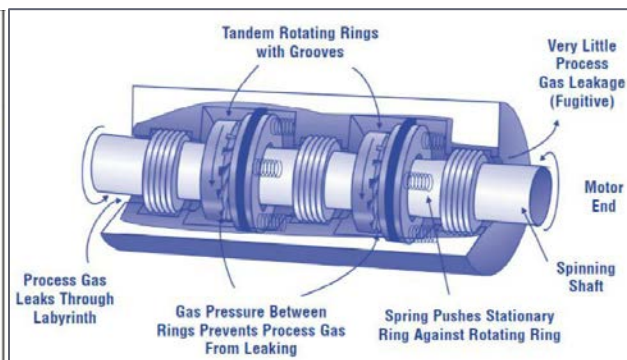

Another source of methane emissions from compressors are the fugitive emissions from piping components, such as valves, flanges, and connectors. These sources of fugitive emissions are not unique to compressors and will be considered in more detail during the LDAR discussion topic.

### Engines

Emissions from engines are typically associated with engine exhaust from combustion of fuel, in this case natural gas. Combustion emissions include primarily NO<sub>x</sub>, CO, VOC and CO<sub>2</sub>. In addition, methane is emitted from the engine exhaust (often referred to as "methane slip" or "combustion slip") and is the result of unburned methane from the fuel that is emitted with the engine exhaust. Methane slip emissions are the result of the fundamental combustion design and type of combustion system for various engine types. The following link to a paper published by the International Council on Combustion Engines (CIMAC) titled "[CIMAC Position Paper, Methane and Formaldehyde Emissions of Gas Engines, April 2014](#)" provides details about methane in engine exhaust.

How are the emissions calculated for this equipment or process?

Emissions for individual compressors and engines can be calculated using emissions factors (for example EPA AP-42 emission factors for engines or GHGRP protocols) in combination with activity data, using engineering calculations, or by direct measurement of emissions.

What data is available to quantify emissions/waste for this equipment or process?

There have been many papers written by a variety of governmental agencies, non-governmental organizations, academia, and industry groups related to methane emissions from compressors and engines. In addition, there have been documents generated during rulemaking activities, primarily the EPA, that include data about emissions from these sources. While not exhaustive, below are links to some of these documents, each citing additional data sources, for example the U.S. EPA Greenhouse Gas

Inventory data. Some of the papers, or cited data sources, generated emission data by direct measurement of emissions.

- 1) EPA Office of Air Quality Planning and Standards (OAQPS), April 2014. From the introduction: “The purpose of this paper is to summarize the EPA’s understanding of vented VOC and methane emissions from compressors, and the EPA’s understanding of available mitigation techniques (practices and equipment) to reduce vented emissions from compressors. Included in the mitigation techniques discussion is our understanding of the efficacy and cost of these technologies and the prevalence of use of the technologies in the industry”. ["Oil and Natural Gas Sector Compressors, Report for Oil and Natural Gas Sector Compressors Review Panel"](#)
- 2) EPA Air Emissions Factors and Quantification. This is a link to EPA background information on natural gas fired reciprocating internal combustion engines (RICE) and Chapter 3.2 of EPA’s *Compilation of Air Pollutant Emissions Factors (AP-42)* for RICE. [AP 42, Fifth Edition, Volume I, Chapter 3: Stationary Internal Combustion Sources.](#)
- 3) EPA Greenhouse Gas Reporting Program.
  - a. This link contains EPA basic information on sources of GHG emissions in the petroleum and natural gas industries (Subpart W), emissions data reported, and guidance for reporters. This subpart covers compressors venting and most fugitive and venting sources from oil and gas facilities, plus engines in the production and gathering and boosting segments. [GHGRP for Petroleum and Natural Gas Systems \(Subpart W\).](#)
  - b. This link contains EPA information on sources of GHG emissions from stationary fuel combustion sources, including engines (Subpart C). This subpart covers engine exhaust emissions at gas processing plants and transmission compressor stations. [GHGRP for General Stationary Fuel Combustion Sources \(Subpart C\).](#)
- 4) Colorado State University, Energy Institute, 2019. From the introduction: “The study had two primary objectives: 1) Collect data on equipment counts and types (activity data) of gathering stations and 2) Perform component level leak measurements suitable for developing new emission factors”. ["Characterization of Methane Emissions from Gathering Stations: Final Report"](#)
- 5) Colorado State University, Energy Institute, 2019. This paper presents the technical information related to the CSU Gathering Station study direct measurement of methane emissions in the exhaust of engines. ["Methane Emissions from Gathering and Boosting Compressor Stations in the U.S. Supporting Volume 2: Compressor Engine Exhaust Measurements"](#)
- 6) Climate & Clean Air Coalition, 2017. From the introduction: “This is a technical guidance document for Partners to the CCAC Oil and Gas Methane Partnership (OGMP). This document is one in a series that describes a core source of methane emissions. The document introduces suggested source-specific methodologies for quantifying methane emissions and describes established mitigation options that Partners should reference when determining if the source is

“mitigated””. This document is specific to centrifugal compressors with wet seals. ["Technical Guidance Document Number 3: Centrifugal Compressors with "Wet" \(Oil\) Seals"](#)

- 7) Climate & Clean Air Coalition, 2017. From the introduction: “This document provides technical guidance to Partners of the CCAC Oil and Gas Methane Partnership (OGMP). It is one in a series describing a core source of methane emissions from oil and natural gas production operations. The guidance documents introduce suggested methodologies for quantifying methane emissions from specific sources and describe established mitigation options that Partners should reference when determining if the source is “mitigated””. This document is specific to reciprocating compressors. ["Technical Guidance Document Number 4: Reciprocating Compressors Rod Seal/Packing Vents"](#)
- 8) Joint Institute for Strategic Energy Analysis, August 2015. From the Executive Summary: “Based on a review of recent research and analysis of the U.S. GHGI emission estimates, this report briefly summarizes the methods and results of the 2014 U.S. GHGI (EPA 2014a), discusses challenges to constructing the U.S. GHGI, and suggests some opportunities that could improve the accuracy of the methane emissions estimates”. ["Estimating U.S. Methane Emissions from the Natural Gas Supply Chain: Approaches, Uncertainties, Current Estimates, and Future Studies"](#)
- 9) INGAA, August 2018. From the introductory comments of the whitepaper: “This white paper supplements those commitments by explaining the sources of methane emissions for the interstate natural gas transmission and storage sector, which is comprised of a network of high-pressure pipelines, compressor stations, and storage assets (salt caverns and reservoirs), as well as the basis for the methane emissions commitments that INGAA members voluntarily adopted”. ["Improving Methane Emissions from Natural Gas Transmission and Storage"](#)
- 10) One Future/ICF International, May 2016. From the Executive Summary: “Our Nation’s Energy Future Coalition (ONE Future) 1 commissioned ICF to conduct this analysis of the marginal abatement cost (MAC) of various methane emission abatement technologies and work practices for the natural gas industry. The goal of this MAC analysis is threefold: (1) to identify the emission sources that provide the greatest opportunity for methane emission reduction from the natural gas system, (2) to develop a comprehensive listing of known emission abatement technologies for each of the identified emission sources, and (3) to calculate the cost of deploying each emission abatement technology and to develop a MAC curve for these emission reductions”. ["Economic Analysis of Methane Emission Reduction Potential from Natural Gas Systems"](#)
- 11) EPA & EC/R Inc., July 2011. From the forward: “This background technical support document (TSD) provides information relevant to the proposal of New Source Performance Standards (NSPS) for limiting VOC emissions from the Oil and Natural Gas Sector”. ["Oil and Natural Gas](#)

[Sector: Standards of Performance for Crude Oil and Natural Gas Production, Transmission, and Distribution: Background Technical Support Document for Proposed Standards"](#)

- 12) EPA & GRI, June 1996. From the introduction: "This report describes how the emissions from compressor driver exhaust were determined. Section 3 discusses the data used to make the emission estimates. Section 4 presents the development of the emission factors for engines and turbines. Section 5 describes the development of the activity factors for each industry segment (production, processing, and transmission, including storage and generators). The annual emissions for each segment and the overall national emissions estimate are provided in Section 6. Conclusions are given in Section 7". ["Methane Emissions from the Natural Gas Industry, Volume II: Compressor Driver Exhaust, Final Report"](#)

**What are the data gaps in quantifying emissions/waste for this equipment?**

Numerous studies have published estimates of methane emissions from compressors and engines, using either top-down or bottom-up methodologies. Each methodology has its associated pros and cons, which results in varying emission estimates and activity data for these sources. Some of the data quality issues or data gaps that impact emission estimates, and therefore the ability to assess effectiveness of reduction efforts, include:

- Variation in emissions between source sub-types, for example different engine designs and configurations.
- Variation in emissions for similar equipment due to specific operational conditions at facilities or across geographic areas.
- Consistency of and lack of activity data and data regarding the number of sources, by type and sub-type, as well as by industry sector.
- Due to changing regulations and application of best practices, data more than a few years old may no longer be representative of actual emissions.
- It has proven difficult to reconcile differences between emission estimates, for example there are some significant inconsistencies between the EPA GHG Inventory and the EPA GHG reporting program data.

Arbitrary categorizations that may obscure important information. For example, EPA GHGRP only uses a single emissions factor, appropriate for a small compressor, for vented gas from any reciprocating compressor located at a well pad. While many compressors at well pads are small, no data is collected on the prevalence of larger compressors at these facilities, which would be expected to have higher emissions.

### **Economic Description of the Process or Equipment:**

**What is the per unit cost of the equipment or the costs associated with the process?**

Equipment costs for engines and compressors vary greatly across the natural gas value chain based on facility requirements, operational conditions, and location. As such, equipment costs must be determined on a case-by-case basis.

What are the annualized operating costs for the equipment or costs associated with the process?

Operating costs for engines and compressors vary greatly across the natural gas value chain based on equipment type, facility requirements, operational conditions, and location. As such, operating costs must be determined on a case-by-case basis.

If the equipment or process is powered, what are the costs?

The cost to power compressors is related to the fuel cost to operate a combustion engine or turbine, or the cost of electricity for compressors that are driven by electric motors. Fuel and electricity costs vary greatly across the natural gas value chain based on equipment type and location. As such, power costs must be determined on a case-by-case basis.

What are the maintenance and repair costs for existing or new equipment?

Maintenance costs for engines and compressors vary greatly across the natural gas value chain based on equipment type, facility requirements, operational conditions, and location. As such, maintenance costs must be determined on a case-by-case basis.

### **Existing Reduction Strategies:**

How has industry reduced emissions/waste from this equipment or process historically?

Voluntary methane emission reduction best practices used in the oil and natural gas industry for compressors and engines are identified in the following link to the EPA Natural Gas STAR Program "[Recommended Technologies to Reduce Methane Emissions](#)".

It should be noted that the information presented by NG STAR partners related to costs to implement methane reduction opportunities may be specific to a location or an individual company. The decision to implement and the cost to implement a voluntary methane reduction technology is always a case-by-case determination based on facility requirements, operational conditions, and location. One example of variation in the feasibility analysis is related to the value of natural gas. Many of the NG STAR opportunities assess cost benefits based on natural gas values that are dated and may not reflect the lower values of natural gas in today's market.

For example, many of the NG STAR examples use a range of value for natural gas of \$3-\$7/Mcf. Gas values today, and for the past 5 years, are typically below \$3/Mcf. It is notable that in some producing basins, including the Permian Basin of SENM, gas values are even more depressed due to local market conditions. Permian Basin spot natural gas prices (at Waha Hub) averaged less than \$0.75/Mcf during

the first eight months of 2019, after touching a record low of negative \$9.00 in April 2019, and compared with an average of \$2.10 in 2018 and a 2014-18 average of \$2.80.

The EIA notes that low Permian Basin spot prices are largely the result of constraints on pipeline capacity, and that prices rose in September in anticipation of the opening of the [Gulf Coast Express Pipeline](#). EIA notes that "Limited natural gas pipeline takeaway capacity from the region has kept prices very low" and that seven additional natural gas pipelines are planned in the region. <https://www.eia.gov/todayinenergy/detail.php?id=41213>.

Primary reduction strategies include:

- Centrifugal Compressor Wet Seals - Replacing Wet Seals with Dry Seals
  - [EPA NG STAR Partner Reported Opportunity](#)
  - May not be technically feasible in some cases due to design of existing compressor or operational conditions, such as:
    - Sour gas service, i.e. gas with H<sub>2</sub>S, common in SENM
    - Certain pressure & temperature conditions
  - If feasible, potential to reduce methane emissions by 95%
  - High cost to implement reported by a NG STAR partner as \$324,000 in 2006 dollars (\$475,000 in today's dollars w/ 3% inflation)
  - May be offset over time by lower OPEX
- Centrifugal Compressor Wet Seals - Wet Seal Degassing Capture
  - [EPA NG STAR Partner Reported Opportunity](#)
  - Collect vapor from seal oil degassing and route for other uses or destruction, such as:
    - Compressor suction
    - High pressure turbine fuel gas
    - Low pressure fuel gas for heaters/burners
    - Flare purge gas
    - Flared, if no use is feasible
  - If feasible, potential to reduce methane emissions by 95%. Some of the above uses may not be feasible, e.g. for sour gas.
  - Requires capital costs to install seal oil separator, oil demister/filter, piping, flow controls, and instrumentation
  - Cost to implement can be highly variable based on facility requirements. One NG STAR partner reported costs to be \$33,000 in 2014 dollars.
- Reciprocating Compressor Rod Packing – Rod Packing Replacement
  - [EPA NG STAR Partner Reported Opportunity](#)
  - Rod packing emissions increase over time due to wear at the seal surfaces

- Replacement of rod packing is routine maintenance task
- Cost to replace compressor rod packings is highly variable
  - Dependent on size of the compressor, composition of the gas being compressed, operating pressures, operating temperatures, other operating conditions (such as demand and speed), technology selected, and materials selected.
- One NG STAR partner reported costs to be \$1,350 - \$1,700 per compression cylinder. For a typical compressor with 4 cylinders this would equate to a range of \$5,400 - \$6,800 for parts & labor
- Reciprocating Compressor Rod Packing – Vapor Capture
  - Collect vapor from rod packing and route for engine fuel
  - May not be feasible for all application, for example sour gas

With regards to methane slip in engine exhaust, the paper published by the International Council on Combustion Engines (CIMAC) titled [“CIMAC Position Paper, Methane and Formaldehyde Emissions of Gas Engines, April 2014”](#) also provides a list of potential methods to reduce methane slip emissions. Many of the reduction methods are related to changing the fundamental design of the combustion chambers in engines to reduce methane slip and improve engine efficiency (Section 6 of the paper). There is also discussion regarding exhaust gas after-treatment using oxidation catalyst to lower methane slip (Section 7 of the paper). At this time, it appears there are unresolved technical issues related to methane conversion at low exhaust temperature and catalyst degradation. Using catalyst to reduce methane emissions appears to be unproven and further development is required to make this technology available. The paper published by One Future/ICF International (May 2016), [“Economic Analysis of Methane Emission Reduction Potential from Natural Gas Systems”](#), states in section 2.3, “Several of the sources identified in Table 2-1 do not have commercially available mitigation technologies (e.g., engine exhaust) ...”.

How have the emission/waste reductions been measured?

Voluntary methane emission reductions are reported by Natural Gas STAR Partners and summarized in EPA’s annual program reports in this link to the [“Natural Gas STAR Program Accomplishments”](#)

How have states and the federal government reduced emissions/waste from this equipment or process historically? In addition, please identify voluntary reductions achieved whether or not they were in response to a regulatory action/requirement.

New compressors have been regulated since 2012 by [the New Source Performance Standard at 40 CFR 60, subpart OOOO](#) and [New Source Performance Standard at 40 CFR 60, subpart OOOOa](#). Under these rules, new centrifugal compressors are required to reduce methane and VOC emissions from wet seal systems by at least 95%, which also provides a similar reduction in methane emissions. Reciprocating

compressors are required to change the rod packing at least every 26,000 operating hours or every 3 years. Modification to existing compressors triggers these NSPS requirements if the change results in an increase in horsepower. Compressors located at a well site, or an adjacent well site and servicing more than one well site, are not subject to these requirements. In lieu of changing the rod packing, NSPS OOOO/OOOOa allows the operator to collect and route emissions from the compressor rod packing to a process through a closed vent system.

Some states have implemented regulations that are more stringent than the federal rules, to reduce VOC emissions in ozone non-attainment areas or as regulations to reduce methane emissions. In Colorado, for example, [per CO Air Quality Control Commission, Regulation 7](#), the federal OOOO/OOOOa compressor requirements generally apply to compressors regardless of installation date (see Reg 7, Sections XII.J.1 & XVII.B.3.b for Centrifugal Compressors and Reg 7, Sections XII.J.2 & XVII.B.3.c for Reciprocating Compressors). In addition, centrifugal compressors with wet seal systems must complete annual inspections and leak monitoring of wet seal capture systems. Unless a compressor is already subject to OOOO/OOOOa, Reg 7, Section XVII.B.3.b & c do not include the same intensive recordkeeping and reporting requirement as provided for in Reg 7, Section XII.J. The recordkeeping and reporting in Section XII.J are a function of ensuring the related emissions reductions can be credited toward the attainment demonstration.

California, Canadian Federal rules, and two Canadian provinces have taken a somewhat different, more protective approach. Canadian jurisdictions require control (approx. 95%) of rod-packing emissions from any new reciprocating compressor.

#### Effective dates – after which new reciprocating compressors must be controlled

Canadian Federal 1/1/2023

Alberta 1/1/2022 (Only recips with 4 or more cylinders)

British Columbia 1/1/2021 (Only recips with 4 or more cylinders)

For existing reciprocating compressors, these jurisdictions require periodic measurement of rod packing vent volumes. Typically, the measurement must be performed annually. After the effective dates listed above (1/1/2019 for California), when an operator measures vent volume in excess of a threshold, the compressor must be repaired (e.g., rod-packing replacement or similar).

#### Vent Volume Repair Thresholds (per cylinder, scf/minute)

California 2.0

Canadian Federal 0.81

Alberta & British Columbia 0.49, *averaged across all compressors in an operator's provincial fleet.*

In Canadian jurisdictions, these rules are applied to all recips except those under 100 HP and (for the provincial rules) those operated less than 450 hours per year. California applies standards to all



compressors operated 200 or more hours per year. The standards described above are applied to all reciprocating compressors except those at wellpads. California subjects wellpad compressors that do not route rod-packing emissions to a process or control to LDAR requirements. If there is any significant amount of vent gas from rod-packing for these compressors, the LDAR program must treat the compressor as a leak source and it must be repaired.

Links for rules discussed above:

Canadian federal standards: <http://gazette.gc.ca/rp-pr/p2/2018/2018-04-26-x1/pdf/g2-152x1.pdf>  
Compressor seal rules are in sections **14** to **19**, which are on pages 10-15 of the pdf

Alberta: [https://www.aer.ca/documents/directives/Directive060\\_2020.pdf](https://www.aer.ca/documents/directives/Directive060_2020.pdf)  
See section 8.6.2, pages 79-82

BC: [http://www.bclaws.ca/civix/document/id/regulationbulletin/regulationbulletin/Reg286\\_2018](http://www.bclaws.ca/civix/document/id/regulationbulletin/regulationbulletin/Reg286_2018)  
See pages 4-6 (section 52.04)

Calif.: <https://ww2.arb.ca.gov/resources/documents/oil-and-gas-regulation>  
See sections 95668(c) and (d), pages 13-18.

New and existing engines have been regulated by the EPA and states for many years, dating to 2004, with a regulatory focus on criteria pollutants (NO<sub>x</sub>, CO, VOC) and hazardous air pollutants (formaldehyde). Federal engine regulations include the [National Emission Standard for Hazardous Air Pollutants at 40 CFR 63, subpart ZZZZ](#), and the [New Source Performance Standard at 40 CFR 60, subpart JJJJ](#). Requirements in NESHAP ZZZZ and NSPS JJJJ for engines vary depending on age, engine type, size, and location. While emission limits and control requirements of these two regulations target NO<sub>x</sub>, CO, VOC, and formaldehyde, methane is also reduced. For example, catalytic controls that reduce other pollutants, also reduce methane, although to a lesser degree. In addition, the maintenance, inspection and testing requirements in these regulations and state issued permits ensure that engines operated in an efficient manner that minimizes methane emissions along with criteria and hazardous air pollutants.

EPA requires annual reporting of GHG emissions from these sources at plants/basins with over 25,000 mtCO<sub>2</sub>e. Also, annual monitoring of vented wet seal and rod packing emissions at subject gas processing plants.

What are examples of process changes/modifications that reduce or eliminate emissions/waste from this equipment or process?

Voluntary emission reduction best practices used in the industry for compressors and engines are identified in the following link to the EPA Natural Gas STAR Program "[Recommended Technologies to Reduce Methane Emissions](#)"

## Technology Alternatives:

List of technology alternatives with link to information or contact information for the company/developers.

Voluntary methane emission reduction best practices used in the industry for compressors and engines are listed the following link to the EPA Natural Gas STAR Program "[Recommended Technologies to Reduce Methane Emissions](#)"

Feasibility and cost of the NG STAR partner reported opportunities are always a case-by-case determination based on facility requirements, operational conditions, and location. One example of variation in the feasibility analysis is related to the value of natural gas. Many of the NG STAR opportunities assess cost benefits based on natural gas values that are dated and may not reflect the lower values of natural gas in today's market.

For example, many of the NG STAR examples use a range of value for natural gas of \$3-\$7/Mcf. Gas values today, and for the past 5 years, are typically below \$3/Mcf. It is notable that in some producing basins, including the Permian Basin of SENM, gas values are even more depressed due to local market conditions. Permian Basin spot natural gas prices (at Waha Hub) averaged less than \$0.75/Mcf during the first eight months of 2019, after touching a record low of negative \$9.00 in April 2019, and compared with an average of \$2.10 in 2018 and a 2014-18 average of \$2.80.

What technology alternatives exist to reduce or detect emissions? Please list all alternatives identified along with contact information for further investigation of this technology or process.

See above link to EPA NG STAR reported opportunities for complete discussion on each reduction technology.

What are the pros and cons of the alternatives?

See above link to EPA NG STAR reported opportunities for complete discussion on each reduction technology.

What is needed and available for new wells?

These emissions are not specific to wells.

What is needed and available for existing wells?

These emissions are not specific to wells.

What technology alternatives exist for this equipment or process itself?

Compression is a basic, must run process for the natural gas industry. No alternatives exist to replace the use of compressors to move natural gas through the value chain.

As discussed in earlier sections, the driver for a compressor can be an internal combustion engine, a combustion turbine, or an electric motor. In some situations, oil and gas operators determine that electrified compression is a viable and preferred technology in place of natural gas fired engines or turbines.

#### What are the pros and cons of the alternatives?

With regards to electric driven compression:

Pros:

- Eliminates local engine/turbine related emissions of criteria pollutants and HAPs, along with methane emissions. There are still emissions, including GHG emissions, related to power generation.

Cons:

- Many locations do not have access to adequate and reliable third-party power
- Cost

### **Costs of Methane Reductions:**

#### What is the cost to achieve methane emission reductions?

Cost of the NG STAR reported opportunities is discussed in the EPA Natural Gas STAR Program "[Recommended Technologies to Reduce Methane Emissions](#)".

Costs are always a case-by-case determination based on facility requirements, operational conditions, and location. Many of the NG STAR opportunities assess cost benefit based on natural gas values that are dated and may not reflect the lower values of natural gas in today's market.

For example, many of the NG STAR examples use a range of value for natural gas of \$3-\$7/Mcf. Gas values today, and for the past 5 years, are typically below \$3/Mcf. It is notable that in some producing basins, including the Permian Basin of SENM, gas values are even more depressed due to local market conditions. Permian Basin spot natural gas prices (at Waha Hub) averaged less than \$0.75/Mcf during the first eight months of 2019, after touching a record low of negative \$9.00 in April 2019, and compared with an average of \$2.10 in 2018 and a 2014-18 average of \$2.80.

Table 1 of the "Cost-Effectiveness of Comprehensive Oil and Gas Emissions Reduction Rules in New Mexico" lists per unit costs for centrifugal compressor abatement technology as \$0.82 per mcf of reduced methane (\$42.64 per tonne).<sup>57</sup>

---

<sup>57</sup> "Cost-Effectiveness of Comprehensive Oil and Gas Emissions Reduction Rules in New Mexico," Erin Camp, PhD, Nate Garner, Asa Hopkins, PhD, Synapse Energy Economics, Inc., September 13,

What would be the implementation cost?

For new wells?

These emissions are not specific to wells.

For existing wells?

These emissions are not specific to wells.

Are there low-cost solutions available?

See EPA Natural Gas STAR opportunities linked above.

If a solution is high-cost, why is that the case?

See EPA Natural Gas STAR opportunities linked above.

Are there additional technical analyses needed to refine benefits/costs estimates?

Costs are always a case-by-case determination based on facility requirements, operational conditions, and location.

### 3. IMPLEMENTATION

For each piece of equipment or process, please consider the following questions and add other relevant information. If relevant, please identify if the answers are different for large company and small company requirements or are different for well type or basin.

#### **Implementation Feasibility:**

What is the feasibility of implementation (availability of required technology or contractors, potential permitting requirements, potential for innovation)?

See EPA Natural Gas STAR opportunities linked above.

What is the useful life of equipment?

See EPA Natural Gas STAR opportunities linked above.

What are the maintenance and repair requirements for equipment required for methane reduction?

See EPA Natural Gas STAR opportunities linked above.

How would emissions be detected, reductions verified and reported?

---

2019, page 9, Table 1, <http://blogs.edf.org/energyexchange/files/2019/09/Synapse-Methane-Cost-Benefit-Report.pdf>.

Emissions for individual compressors and engines can be calculated using emissions factors (for example EPA AP-42 emission factors for engines or GHGRP protocols) in combination with activity data, using engineering calculations, or by direct measurement of emissions.

## 4. CHALLENGES AND OPPORTUNITIES TO ACHIEVE METHANE REDUCTION IN NEW MEXICO

For each piece of equipment or process, please consider the following questions and add other relevant information. If relevant, please identify if the answers are different for large company and small company requirements or are different for well type or basin.

What regulatory gaps exist for this equipment or process? Are there regulatory gaps filled by the proposed implementation?

See Section 2 above regarding regulation of compressors and engines. Potential gaps are related to sources that are not covered by NSPS OOOO/OOOOa (grandfathered) or are located at wellsites.

Where do conflicting priorities exist between NMED, EMNRD, and NMSLO? Are there opportunities for coordination between these agencies?

Engines and compressors are stationary sources located at facilities subject to NMED air quality rules and permits.

Are there existing regulations related to methane that do not address the intended purpose? Identify any unintended barriers to methane reductions/capture that may hinder proposed processes.

NA

Other considerations or comments (e.g. particular design or technological challenges/opportunities, co-benefits, non-air environmental impacts, etc.):

## 5. COMPRESSORS AND ENGINES- PATH FORWARD<sup>58</sup>

	OPTIONS	DESCRIPTION AND LINK TO INFORMATION IF AVAILABLE. PLEASE LIST THE BENEFIT THAT COULD BE ACHIEVED THROUGH THIS OPTION AND ANY DRAWBACKS OR CHALLENGES TO IMPLEMENTATION	EMISSIONS REDUCTIONS ARE EASY TO ACHIEVE AND ARE COST EFFECTIVE  1 = EASY 5 = HARD	REPORTING, MONITORING AND RECORDING OPTIONS, INCLUDING REMOTE DATA COLLECTION	IS THIS OPTION HELPFUL IN THE SAN JUAN BASIN, PERMIAN BASIN OR BOTH
4.1	Centrifugal Compressor Wet Seals - Wet Seal Degassing Capture: retrofit wet seal installations with equipment that directs gas from seal oil degassing unit to other use, or flare for destruction.	<p><a href="https://www.epa.gov/sites/production/files/2016-06/documents/capturemethanefromcentrifugalcompressorwetsealdegassing.pdf">https://www.epa.gov/sites/production/files/2016-06/documents/capturemethanefromcentrifugalcompressorwetsealdegassing.pdf</a></p> <p>Capture for use may not be technically feasible in some cases due to design of existing compressor or operational conditions, such as:</p> <ul style="list-style-type: none"> <li>• Sour gas service, i.e. gas with H<sub>2</sub>S, common in SENM</li> </ul> <p>If feasible, potential to reduce methane emissions by 95%. Some of the above uses may not be feasible, e.g. for sour gas.</p> <p>Requires capital costs to install seal oil separator, oil demister/filter, piping, flow controls, and instrumentation. Cost to implement can be highly variable based on facility requirements. One NG STAR partner reported costs to be \$33,000 in 2014 dollars.</p>	1 2 3 4 5		San Juan  Permian  Both

<sup>58</sup> The format of the Path Forward table evolved over the course of the meetings as the group tried to identify the best method for capturing the most useful information. As a result, there is some variation in the table headers from topic to topic in the final consolidated report.

		While flaring is less preferred than capture for use due to waste & emissions of CO2 and other pollutants, it is certainly preferable to venting.			
	COMMENT		SUGGESTION TO MAKE THIS OPTION MORE WORKABLE:		
4.2	Centrifugal Compressor Wet Seals - Replacing Wet Seals with Dry Seals	<a href="https://www.epa.gov/sites/production/files/2016-06/documents/capturemethanefromcentrifugalcompressionssealoiddegassing.pdf">https://www.epa.gov/sites/production/files/2016-06/documents/capturemethanefromcentrifugalcompressionssealoiddegassing.pdf</a>  May not be technically feasible in some cases due to design of existing compressor or operational conditions, such as: <ul style="list-style-type: none"> <li>• Sour gas service, i.e. gas with H2S, common in SENM</li> <li>• Certain pressure &amp; temperature conditions</li> </ul> If feasible, potential to reduce methane emissions by 95%.  High cost to implement reported by a NG STAR partner as \$324,000 in 2006 dollars (\$475,000 in today's dollars w/ 3% inflation). Costs may be offset by lower opex after retrofit.	1 2 3 4 5		San Juan  Permian  Both
	COMMENT A. Wet seals do not apply to reciprocating compressors. [page 88]		SUGGESTION TO MAKE THIS OPTION MORE WORKABLE:		
4.3	Reciprocating Compressor Rod Packing – Vapor Capture and route for engine fuel [page 95]	May not be feasible for all application, for example sour gas	1 2 3 4 5		San Juan  Permian  Both
	COMMENT A. The concerns raised by EPA are still valid. In the Federal Register notice dated August 23, 2011 regarding proposed NSPS Subpart OOOO regulation, EPA evaluated the possibility of reducing VOC emissions from a control device but did not propose it due to technical considerations at Page 53762: “Although it is possible to construct an enclosure around the rod packing area and vent the emissions outside for safety purposes, connection to a closed vent system would		SUGGESTION TO MAKE THIS OPTION MORE WORKABLE:		

	<p>create back pressure on the leaking gas. This back pressure would cause the leaked gas instead to be forced inside the crankcase of the engine, which would dilute lubricating oil, causing premature failure of engine bearings, pose an explosion hazard and eventually be vented from the crankcase breather, defeating the purpose of a control device.”</p> <p>B. Allowed in other states [cite in paper]</p>									
4.4	<p>Reciprocating Compressor Rod Packing – Rod Packing Replacement [page 94]</p>	<p><a href="https://www.epa.gov/sites/production/files/2016-06/documents/ll_rodpack.pdf">https://www.epa.gov/sites/production/files/2016-06/documents/ll_rodpack.pdf</a></p>	1	2	3	4	5	San Juan	Permian	Both
	<p>COMMENT</p> <p>A. Cost to replace compressor rod packings is highly variable. Dependent on size of the compressor, composition of the gas being compressed, operating pressures, operating temperatures, other operating conditions (such as demand and speed), technology selected, and materials selected. [page 95]</p> <p>B. One NG STAR partner reported costs to be \$1,350 - \$1,700 per compression cylinder. For a typical compressor with 4 cylinders this would equate to a range of \$5,400 - \$6,800 for parts &amp; labor [page 95]</p> <p>C. [Reference not in paper.] In the Federal Register notice dated August 23, 2011 regarding proposed NSPS Subpart OOOO regulation, EPA considered the cost-effectiveness of replacing rod packing replacement costs for reciprocating compressors at wellheads at <a href="#">Page 53762</a>: “Reciprocating compressors at wellheads are small and operate at lower pressures, which limit VOC emissions from these sources. Due to the low VOC emissions from these compressors, about 0.044 tpy, combined with an annual cost of approximately \$3,700, the cost per ton of VOC reduction is rather high. We estimated that the cost effectiveness of controlling wellhead compressors is over \$84,000 per ton of VOC reduced which we believe to be too high, and therefore, not reasonable.”</p>		<p>SUGGESTION TO MAKE THIS OPTION MORE WORKABLE:</p>							



	EPA estimated the cost effectiveness of VOC emissions by rod packing replacement would be \$870 per ton of VOC at gathering and boosting stations. The cost effectiveness numbers would have to be evaluated for the new well site compressors which may be larger. However, for many of the older, existing well site compressors these numbers may still be valid.							
4.5	Reciprocating Compressors: Annual volumetric measurement of rod-packing venting; repair compressor when emissions exceed threshold level.	See California & Canadian rule material. California rules distinguish between compressors at production facilities and other facilities (including gathering and boosting, transmission etc.). At production facilities, the rules require leak detection measurement. Volumetric measurement is required at facilities other than production.	1	2	3	4	5	San Juan Permian Both
COMMENT			SUGGESTION TO MAKE THIS OPTION MORE WORKABLE:					

# SECTION 5, INFRASTRUCTURE PLANNING

Discussion for MAP members on October 10, 2019

---

NOTE: The focus of this report is processes, and the associated equipment, directly related to the release or capture of methane gas. We are not requesting information on processes/equipment that are not related to the release or capture of methane gas.

## 1. DESCRIPTION OF PROCESS AND EQUIPMENT

Provide a description of the processes and/or equipment used in oil and/or gas extraction for this topic. Note that this report template will be used for all topics of the MAP review and, thus, not all questions or information may be relevant for each topic. If information is not relevant, indicate N/A. Note any differences expected for differing well types, industry sector, or basin location.

Technical description of the process or equipment:

Infrastructure is a broad topic within the oil and gas space. This paper will mainly focus on pipelines and associated facilities, as well as the planning process for well development and gathering facility infrastructure. As a general matter, however, oil and gas infrastructure can include pipelines, gas compression, gas processing, NGL fractionation, gas storage, oil terminals, oil refining, trucks, barges and downstream operations such as residential, commercial, and industrial. Here is a graphic to demonstrate such infrastructure:

- **Upstream**
  - Drilling
  - Production
- **Midstream**
  - Transportation
  - Treatment
- **Downstream**
  - Industrial
  - Residential
  - Commercial

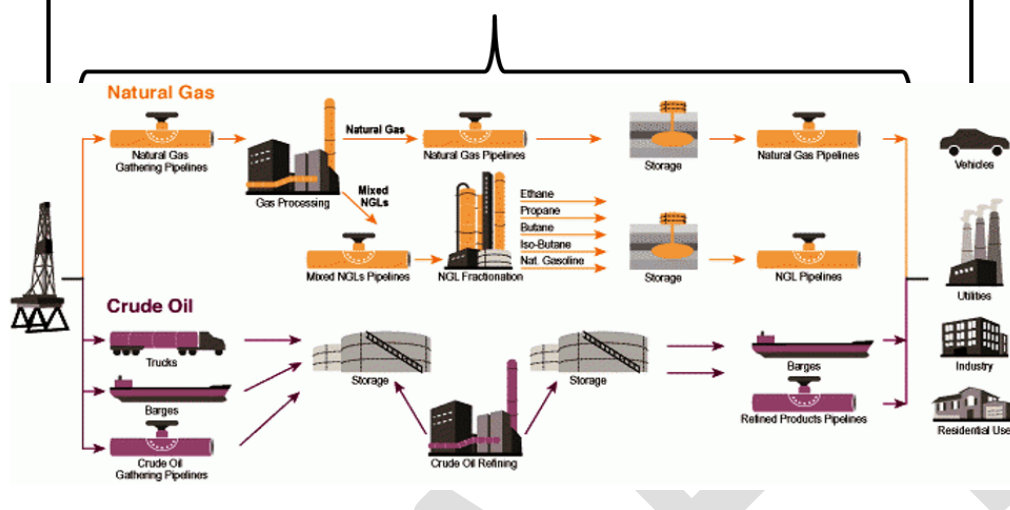

1. The Growth Project Planning Process (Business Development)

- a. Buildout of midstream (gathering and processing, intrastate pipelines) and downstream (interstate pipelines, storage, fractionation and refining) facilities is a complex commercial process that requires collaboration between operators in each industry segment. New capacity won't be constructed without some degree of certainty around future drilling activity and production, which are ultimately driven by market demand, pricing, producer financing/growth strategy, regulatory climate, etc.
- i. Midstream gas gathering and processing facilities. Natural gas may be produced from gas wells, which are drilled primarily to produce natural gas (together with some component of natural gas liquids (NGLs) and/or condensate), or as associated gas that is produced essentially as a byproduct of wells that are drilled primarily to produce crude oil. In either case, in order to facilitate and provide a market for growing natural gas production, midstream companies must make long-term capital investment decisions in advance to construct the infrastructure necessary to gather and process producers' gas volumes.

Those midstream facilities are generally comprised of gathering pipeline systems that connect to individual wells, field compression or "booster" facilities, and natural gas processing plants (collectively, gathering and processing or "G&P" facilities). These G&P facilities are designed to operate over a long useful life (30+ years) in order to service production in a particular geographic area; they are permanently located facilities that require ongoing maintenance capital and have a much lengthier capital recovery horizon when contrasted to an upstream producer's investment in an individual well. While upstream producers can elect how and where to drill their acreage, reallocating their capital budgets from basin to basin, G&P assets remain in place once built.

As a result, in order to construct new G&P capacity, midstream companies seek to secure substantial acreage commitments or minimum volume dedications from producers in advance of a final investment decision. Producers benefit from these arrangements by having a market for their production, often at preferable terms offered by the midstream operator in order to secure their advance commitment. Absent these types of commitments, a midstream company faces the risk that competitors might

undercut their growth strategy by obtaining similar dedications, or that drilling activity might shift to another basin or geographic region, leaving their own newly constructed G&P facilities behind as stranded investments.

- ii. Downstream long-haul takeaway pipelines. Before pipeline developers break ground on the construction of a new pipeline, which can cost billions of dollars, the developers seek long-term commitments to ship oil, gas, or NGLs through the pipeline. Shippers may elect to sign long-term contracts during a period called an “open season.” During the open season, a shipper can sign a Transportation Services Agreement, or TSA, agreeing to ship a certain quantity at a certain rate for a certain term if the pipeline is built, thereby securing “firm” or guaranteed pipeline access for the volume committed.

Before a pipeline company commits to building a pipeline, the company tries to obtain a minimum level of shipping commitments through TSAs. Shippers typically benefit from committing during the open season because the rates offered during an open season to shippers willing to make a long-term shipping commitment are usually lower than the rates charged to other shippers who do not commit yet seek access after the pipeline is constructed.

- b. Over time, the necessary midstream and downstream infrastructure will ultimately be developed to accommodate long term production trends, but not without encountering periods marked either by bottlenecks or by excess capacity. Bottlenecks or capacity constraints are particularly relevant to and may result in periodic increases in flaring.
  - c. Notably, additional constraints may and in recent years have developed further downstream, in the form of limited NGL fractionation capacity. Long-haul NGL pipelines typically ship “Y-grade” NGL product, which is a blend of NGLs (ethane, propane, butane, isobutene, etc.) in their mixed, unfractionated form. Once the Y-grade product reaches downstream markets – which for Permian Basin production is generally centered on the Texas gulf coast in and around Mont Belvieu, Texas – downstream purchasers fractionate or separate the Y-grade into constituent purity products for further marketing and use.
  - d. As drilling activity fluctuates over time and initial production levels from new wells tapers off, G&P systems typically have capacity available to connect new wells from existing and/or new producer customers, whether from dedicated acreage or not.
2. Connecting Wells to Midstream Gathering Pipelines: Right-of-Way Acquisition
- a. The process of connecting wells to gas gathering systems begins with right-of-way (ROW) acquisition. Once commercial negotiations are complete and an agreement is in place between the upstream producer and the midstream operator, midstream ROW professionals receive authorization to initiate the process beginning with a survey that is used to determine the planned route of the gathering pipeline and any associated compression facilities or other appurtenances. Depending upon land ownership patterns along the selected route, the process and permitting requirements vary as outlined below.
    - i. Federal Lands (primarily BLM, but also Tribal, USFS, BOR, etc.). The same general process and requirements apply to securing ROW for gathering pipelines, compressor stations, or gas processing plants. The midstream operator as applicant submits to the agency a route or location survey together with an environmental assessment, archaeological study, geologic survey (karsts) and all other materials required to be submitted with the ROW application in conformance with all applicable federal laws (separate authorization is required for the U.S. Army Corps of Engineers for regulated crossings of navigable waters). The application goes through multiple levels of review by Natural Resource Specialists, each of whom has a specific area of expertise in determining the completeness and adequacy of the application and considering any potential conditions to be placed on the ROW grant. The standard term for a BLM ROW grant is 30 years.

Each year BLM offices in New Mexico ask operators for any available planning information or forecast of anticipated ROW activity for the upcoming year, in an effort to budget their own offices and activities. While these can be difficult for midstream operators to forecast with accuracy, efforts are made in an effort to ensure adequate agency staffing levels, which is a persistent and historical source of project delay.

- ii. State Lands. The New Mexico State Land Office (SLO) has jurisdiction over a vast amount of state trust lands located in the heart of the oil and gas producing areas of the state. While the process for obtaining ROW grant on state lands is very similar to that for federal lands, there are some differences. Gathering pipelines are laid under a ROW agreement, which is initiated by filing a completed application that includes a survey (conducted under the prior approval of the SLO). The ROW application is reviewed by the appropriate SLO District Resource Manager, which can be a source of delay based solely on personnel limitations and workloads: currently, the SLO needs to staff more appropriately. After staff review, a grant agreement is sent back to the applicant for review and signature, after which it is submitted for final approval by the Land Commissioner and execution of the ROW grant agreement. The standard term for an SLO ROW grant is 35 years.

Natural gas compressor stations and processing plants can be located on state lands pursuant to a business lease, rather than a ROW grant. Application requirements are similar to those required for ROW, but at times delays are incurred if the surface area is already subject to a grazing lease. In these instances, the SLO leaves it to the midstream operator to obtain from the grazing lessee either (a) a relinquishment of acreage from the grazing lease, or (b) a right to lease leased lands, an arrangement that must thereafter be renewed every 5 years.

- iii. Private Lands. ROW acquisition on private lands is a private negotiation and transaction between the midstream operator and the landowner. The midstream company determines the intended pipeline route and initiates contact with the affected landowner(s) that are identified. ROW agents typically obtain permission to conduct survey while negotiations are taking place, and once the parties reach agreement the ROW easement is conveyed and the landowner is compensated with the amount agreed to. If a landowner wishes not to engage in negotiations and grant an easement, the company seeks alternate routes and/or works with the upstream producer to potentially lay gathering lines pursuant to their rights of access under the oil and gas lease or landowner surface agreement.
- iv. Tribal Nations
  - 1. Navajo Nation
  - 2. Jicarilla Apache Nation
  - 3. Pueblo
  - 4. Ute
  - 5. Indian Allottee

### 3. Permitting Requirements for Midstream Facilities (non-ROW)

- a. Upstream, midstream, and downstream operators each face their own unique suite of regulatory schemes that entail numerous but often varying federal and state permitting agencies, which operate pursuant to different organic statutes. Ultimately, project timing and execution can be impacted by agency funding and/or staffing issues, changes in laws, regulation, or political leadership, opposition by landowners, NGOs, and others, etc. For projects located in New Mexico, the relevant agencies and processes are summarized below.
  - i. U.S. Federal Energy Regulatory Commission (FERC)
    - 1. Certificate of Public Convenience and Necessity (interstate pipelines)

- 2. Regulation of rates, terms and conditions of service (interstate pipelines)
- ii. U.S. Environmental Protection Agency (EPA)
  - 1. NPDES discharge permits
  - 2. Spill Prevention, Control, and Countermeasure (SPCC) permits
- iii. U.S. Army Corps of Engineers
  - 1. Nationwide permits (navigable water crossings)
- iv. New Mexico Environment Department
  - 1. Air construction/operation permits (state and federal EPA requirements)
  - 2. Hazardous waste generation/transport/storage
  - 3. Underground storage tanks
  - 4. Drinking water systems
- v. New Mexico EMNRD, Oil Conservation Division
  - 1. Pipeline hydrostatic test water discharge (pipeline construction)
  - 2. WQCC/discharge permits
  - 3. Below-grade tanks/pit permits
  - 4. AGI/disposal wells

#### 4. Planned Maintenance Activities

- a. As with our own personal vehicles, in order to responsibly maintain the reliable and safe operation of midstream G&P systems, these assets are subject to regular and routine maintenance activities. Depending on production volumes flowing from upstream wells and space available on downstream takeaway pipelines, these planned activities can either be performed with little or no interruption in production flow or may result in upstream curtailment, which may at times lead to flaring.

Gas processors make volume commitments or “nominations” for residue gas sales into downstream interstate pipelines one to two days ahead of actual delivery. If, on a Monday, a processor is making nominations for Wednesday deliveries and knows that planned maintenance activities are scheduled at either a compressions station or a processing plant on that date, the processor will lower the volume of gas nominated accordingly. In some circumstances, the processor will be able to reroute volumes upstream of the compressor or plant to another facility with available capacity, increasing nominations on an alternate pipeline and proceeding with little or no upstream disruption. If gas cannot be rerouted, the planned maintenance may require upstream production volumes to be shut in at the wellhead. G&P field personnel will inform producer customers usually a full day in advance, communicating the nature and expected duration of the maintenance activity.

For extended maintenance activities that will keep G&P operations offline for an extended period of time, midstream companies will typically send written notice of curtailment or volume allocation to their customers. Different equipment and components have different maintenance schedules, with defined maintenance due at 30/60/90,000 operating hour intervals, or annual vs. 5-year shutdowns and repair. A “turnaround” is a scheduled maintenance activity that may keep a facility down for 5-10 days for engine overhauls, vessel inspection and repair, fixing of leaks identified by LDAR inspection, etc.

#### 5. Infrastructure Challenges

- a. Not all assets are created equally. Gas processing facilities, for example, can vary greatly in how they are designed and operated, based in part on whether they are paired with a certain level of field treatment, and variables such as the quality characteristics of the raw product at the inlet (e.g., wet vs. dry gas, SO<sub>2</sub> content, contaminants, etc.). Age of the system, variations in field pressures, and third-party incidents can also cause system-wide disruptions irrespective of any regulatory scheme that might be imposed. Often overlooked,

human resources can often be an overriding and sometimes persistent factor in achieving optimal operation of various assets, implicating regulatory compliance and emissions performance.

The age or “vintage” of a G&P system often dictates how new production is connected. Much of the recent production growth in SENM is being serviced by newly constructed facilities in which gathering systems, compression and processing are all designed to accommodate the high volumes and pressures associated with horizontal drilling. In many instances, older existing systems may have been designed for lower-pressure vertical (legacy) production and were not constructed to standards that allow for the safe gathering of gas at the volumes and pressures associated with most modern horizontal shale wells.

Fluctuations in any one or more of these variables may result in operational upsets of midstream facilities that lead to unplanned maintenance and repair events, whether that be in response to an issue or event or something else, such as the installation of system upgrades.

- b. Availability of electrical infrastructure can create operational issues. The need for available and reliable power can create operational challenges for infrastructure. Onsite power generation may be needed to control or power a process. The ability, or the lack thereof, to have power can slow or impede infrastructure development.

Electricity reliability and voltage requirements-Oilfield equipment power requirements are quite varied ranging from instrumentation at a single well pad needing approximately 35W to operate up to approximately 2,000 kW (note unit change) to operate a single frac/stimulation pump. The power demand required to operate equipment determines if single phase power (household) is adequate or if three phase power (industrial) is necessary.

In the overall electrical grid, distribution substations connect to the transmission system and lower the transmission voltage to medium voltage (2kV and 35kV) using transformers. Primary distribution lines carry this medium voltage power to distribution transformers located closer to end users. Most customers are connected to the secondary distribution system through service drops. Customers demanding much larger amounts of power may be connected directly to the primary distribution level or the subtransmission level.

Much of the commonly seen distribution lines are secondary distribution systems for domestic and commercial needs that do not require high voltage transmission. The proximity of primary distribution level or subtransmission level to the required location is critical in determining 1) the economic feasibility of utilizing high voltage (3 phase) grid power to operate upstream and midstream higher HP equipment and 2) the timing around getting the local utility to run the necessary lines to the site. In many cases, higher HP equipment will need to be operated on generators due to both proximity of adequate transmission lines, lead times for connecting lines, and potential issues with grid instability resulting from high demand users on a system not originally designed for industry load.

In general, most of the compressors, engines and motors utilized in the oilfield require 3 phase power. This equipment is utilized for artificial lift, dehydration, gas compression, etc. Equipment that has the potential to operate on potentially more readily available single phase power, such as instrumentation and controllers, are critical to safe operation of the facilities. Due to the critical nature of this equipment, an unreliable or unstable grid, will result in unnecessary facility shutdowns when power is insufficient. The system upsets caused by potential outages from an unstable grid can result in equipment damage, well damage, and flaring. In addition, even secondary transmission lines may not be available in very rural areas. It can sometimes take

months of working with the local utilities to get even secondary transmission lines run to the facility, which is only adequate to operate a small amount of onsite equipment.

Due to the challenges around the development of adequate power supply to remote locations, many sites are supplied by onsite generation.

Infrastructure planning for oil and natural gas is the process by which producers, midstream operators, state and federal regulators, and state and federal land managers collectively, but not necessarily in coordination, determine the timing, extent, and location of new or re-fractured oil and gas wells, natural gas gathering and boosting systems (i.e., pipelines and compressors) and processing plants, as well as oil transport modes and facilities which are not addressed here.

Currently, infrastructure planning occurs primarily within individual segments of the oil and gas value chain or within individual firms, and it takes the form of multiple individual decisions by those entities, with some, but limited, information exchange and coordination. Producers make decisions to acquire new leases, drill new wells, re-complete existing wells, operate and maintain existing wells, and sometimes invest in flow lines and compressors. Midstream companies build or expand gathering, boosting, and processing infrastructure. Planning for a particular segment, for example production, may take place amongst several companies whose leaseholds are unitized.

As noted above, federal, tribal, state, and local agencies oversee and approve different aspects of such activities, including by determining, for federal public lands and state trust lands, where lands should be leased for development or where rights-of-way for infrastructure, such as pipelines, are appropriate. This oversight is also often fragmented, a function of “checkerboarded” land ownership prevalent in New Mexico and distinct, if sometimes overlapping, legal and regulatory authorities.

A critical outcome of infrastructure planning, or the lack thereof, is the alignment, or misalignment, between the volumes and locations of gas produced, particularly with respect to the associated natural gas produced at oil wells, and the capacity of natural gas gathering and processing systems to bring that gas to market.<sup>59</sup> Where there is insufficient available gathering, compression, and processing capacity for the amount of gas produced, operators must handle the gas through other means. Gas that is produced but not beneficially used by the producer at the well or fed into the gathering system is typically vented or flared. Both venting and flaring release pollution and constitute waste—the loss of the natural gas resource that could otherwise be sold into the market.

A substantial volume of gas is vented or flared in New Mexico, and the volume has been rising with the recent production boom, as discussed below in Section 2. However, there is tremendous variation among producers in the share of production that is reported as vented or flared, ranging from zero methane waste to 100% waste, with rates from 10% to almost 70% seen among major producers. Producers with associated gas and relatively little reported venting and flaring presumably have coordinated their planning with midstream companies to optimize the location and timing of anticipated production for takeaway. Associated gas producers with high reported rates of venting and flaring presumably have insufficient access to gathering and processing system infrastructure, which can indicate insufficient development planning and coordination with midstream companies.

---

<sup>59</sup> Associated gas is defined as natural gas that is produced from oil wells during unconventional oil production (also referred to as shale oil or tight oil). “Improving utilization of associated gas in U.S. tight oil fields”, Carbon Limits, April 2015. [https://www.catf.us/wp-content/uploads/2015/04/CATF\\_Pub\\_PuttingOuttheFire.pdf](https://www.catf.us/wp-content/uploads/2015/04/CATF_Pub_PuttingOuttheFire.pdf)



While inadequate infrastructure planning is one explanation for infrastructure misalignment and waste, there are other plausible explanations as well. These include violation of the state’s ban on venting from gas wells (NMAC 19.15.19.10 <http://164.64.110.134/parts/title19/19.015.0019.pdf>), violations of the state’s time limit for venting and flaring from oil wells (NMAC 19.15.18.12 <http://164.64.110.134/parts/title19/19.015.0018.html>), and abuse of the No-Flare Rule Exception process; i.e., long-term flaring via serial approvals (Form C-129 Application for Exception to No-Flare Rule <http://www.emnrd.state.nm.us/OCD/documents/C-12920110801.pdf>). It is also possible that of the venting and flaring reported to OCD on the C-115s, venting is from oil wells only and venting and flaring is within the 60-day limit after completions or authorized through C-129 exceptions. In any case, industry, states, and the Federal government have recognized the strong connection between methane emissions and waste, and infrastructure planning, as discussed below in Section 2.

Provide the segment(s) of the industry that conduct infrastructure planning the equipment or process is found:

Infrastructure can be found in upstream, midstream, and downstream business segments.

Upstream and midstream. As noted, the U.S. Bureau of Land Management (BLM) and State Land Office also influence infrastructure planning activity through the leasing of, respectively, federal public or state trust lands for oil and gas development and issuance of rights-of-way. To illustrate how this plays out for federal public lands, BLM manages oil and gas development through a three-stage process. First, BLM prepares “Resource Management Plans” that govern what lands are open to leasing and under what conditions. Second, BLM sells leases, which are specifically conditioned via the use of lease stipulations. Third, the BLM approves specific Applications for Permit to Drill or rights-of-way. In this third and site-specific stage, BLM may impose Conditions of Approval consistent with law and lease rights. BLM also plays a role in the unitization and communitization of leases with the goal of facilitating orderly and efficient development of federal leases.

Describe how the equipment or process is used:

Oil and gas infrastructure in New Mexico includes pipelines, natural gas compression facilities, natural gas processing, oil terminals, and oil refinery/fractionation.

Infrastructure planning by upstream producers can generate information for midstream companies about the timing and location of well development and projected production volumes with sufficient advance notice to enable midstream companies to respond with adequate gathering and processing capacity. While midstream companies may view the current process and level of information exchange as generally adequate for their own business purposes, the large volumes of venting and flaring indicate that additional large volumes of gas could be marketed if gathering capacity were sufficiently available where and when operators develop oil wells with associated gas. Midstream entities evaluate expected regional volumes for assessment in their hydraulic analyses and improved gas capture planning with better information about expected gas takeaway strategy and capacity at the future date of completion could improve the ability of midstream entities to conduct these analyses and support investment planning. Conversely, midstream companies could share existing and planned future capacity information with E&P operators during the commercial and business development process to better align E&P operators’ drilling schedules and other investments.

Conversely, planning by midstream companies can inform producers of existing capacity, projected capacity additions, and capacity constraints, allowing producers to respond proactively, such as by locating and timing development to coincide with projected available gathering capacity, or by pausing or slowing production. For example, “Some companies have recently opted to scale back production in the gassier portions of the Permian. In April, Houston's

Apache Corp. said it dramatically cut back natural gas production in its Alpine High development in the Permian because of steep pricing discounts caused by pipeline shortages.”

“Permian gas flaring hits new record highs for 'widespread waste,' pollution.” The Houston Chronicle, June 4, 2019

<https://www.houstonchronicle.com/business/energy/article/Permian-methane-emissions-back-on-the-rise-after-14412700.php>

Also, midstream companies can inform producers of short-term capacity constraints from, e.g., planned maintenance activities, to allow producers to prepare to use other means to capture gas or temporarily pause production during such activities.

Provide the common process configurations that use this equipment or process:

n/a

What is the distribution of the equipment or process across business segments?

The process to build infrastructure is application, geographic, weather, and terrain specific.

How has this equipment or process evolved over time?

n/a

## 2. INFORMATION ON EQUIPMENT OR PROCESS COSTS, SOURCES OF METHANE EMISSIONS, AND REDUCTION OR CONTROL OPTIONS

Identify the capital and operating costs for the equipment or the process. Identify how methane is emitted or could be leaked into the air. Please **prioritize** the list to identify first the largest source of methane from the process or equipment and where there is **potential** for the greatest reduction of methane emissions. Note any differences expected for differing well types, industry sector, or basin location.

### Sources of Methane:

Provide an overview of the sources of methane from this equipment or process:

Possible sources of methane can come from Natural Gas and Oil infrastructure.

The main source of methane emissions and waste linked to poor infrastructure planning is the venting and flaring of associated gas. According to production statistics reported by Operators to the OCD, Operators vented 3.1 MMcf or 0.2% of total production in 2018 and 1.4 MMcf or 0.2% of production in the first half of 2019. Operators flared 33.4 MMcf or 2.2% of total production in 2018 and 16.8 MMcf or 2% of total production for the first half of 2019. As discussed below, venting and flaring rates are considerably higher when only oil wells are considered.

Venting emits methane directly, as methane is the largest constituent of natural gas. Flaring also emits some methane due to incomplete combustion, and the amount of methane will be large if the flare is malfunctioning or unlit. Where air permits are required, compliant flares should achieve methane destruction rates of between 95-98%, with 2-5% of the gas emitted uncombusted.

[https://www.env.nm.gov/wp-content/uploads/2018/04/GCP-Oil\\_Gas.pdf](https://www.env.nm.gov/wp-content/uploads/2018/04/GCP-Oil_Gas.pdf)

It is important to note that while substituting flaring substantially reduces the climate impacts of venting methane, flaring still directly releases CO<sub>2</sub> and smaller quantities of methane, as well as wasting the resource. At large volumes of flaring, the combined CO<sub>2</sub> and methane emissions from flares can have climate impacts comparable to those of other large sources. For example, if venting and flaring from oil and gas production in NM continue at the current pace for the remainder of 2019, the resulting volume of GHG emissions will be equivalent to the GHG emissions from two units of the coal-fired San Juan Generating Station over the same period (see Exhibit 1 for calculations).

#### New Wells:

See venting and flaring topic paper.

Venting and flaring will occur at new wells if take-away capacity or field use does not accommodate all of the gas that is produced. New wells, by virtue of high initial production pressures, may also “bump off” older, lower-pressure wells from natural gas gathering systems, leading to operators deciding to vent or flare natural gas at those older sites.

#### Existing Wells:

See venting and flaring, pneumatics, compression topic papers.

Venting and flaring will occur at existing wells if take-away capacity or field use does not accommodate all of the gas that is produced. Again, existing wells may also get “bumped off” of gathering systems if they lack needed compression when new, higher-pressure wells come on-line, resulting in venting or flaring of natural gas that, before the new well came on-line, was able to flow through the natural gas gathering system.

#### How are the emissions calculated for this equipment or process?

NMED currently regulates midstream facilities, such as natural gas compression and oil terminals.

Vented and flared volumes are reported to OCD by operators on Form C-115 Operator’s Monthly Report, which records the volumes of oil and gas production and disposition by well. For a description see [http://www.emnrd.state.nm.us/OCD/documents/C115\\_Instructions2019.pdf](http://www.emnrd.state.nm.us/OCD/documents/C115_Instructions2019.pdf)

Any Vented/blowdown volumes greater than 50 MCF released from a pipeline are required to be reported to NMOCD via the C-141 report. NMAC 19.15.29.7

<http://164.64.110.134/parts/title19/19.015.0029.html>

#### What data is available to quantify emissions/waste for this equipment or process?

Depending on size, midstream facilities (e.g. most compressor stations, gas plants, or oil terminals) require NMED air permits and any excess emission during a routine or predictable startup, shutdown, or scheduled maintenance event (20.2.7.7 D. & 20.2.7.110 NMAC). The Air Quality Bureau has recently announced a new initiative to post excess emissions online on a monthly basis. See <https://content.govdelivery.com/accounts/NMED/bulletins/2664784>

**"Excess emission"** means the emission of an air contaminant, including a fugitive emission, in excess of the quantity, rate, opacity or concentration specified by an air quality regulation or permit condition.

<http://164.64.110.134/parts/title20/20.002.0007.html>

EPA Greenhouse Gas Reporting Rule also include pipelines and gathering systems under the gathering and boosting.

**Onshore petroleum and natural gas gathering and boosting** means gathering pipelines and other equipment used to collect petroleum and/or natural gas from onshore production wells and to compress and transport gas to a natural gas processing facility, transmission pipeline, or a distribution pipeline.

[https://www.ecfr.gov/cgi-bin/text-idx?tpl=/ecfrbrowse/Title40/40cfr98\\_main\\_02.tpl](https://www.ecfr.gov/cgi-bin/text-idx?tpl=/ecfrbrowse/Title40/40cfr98_main_02.tpl)

<https://www.epa.gov/ghgreporting/ghgrp-and-oil-and-gas-industry>

As shown in Table 1 below, overall reported venting and flaring from all oil and gas operations in New Mexico increased by 115% in 2018 and by 21% for the first half of 2019, far outpacing increased gas production in 2018 and keeping pace with the gas production increase thus far for this year, which is also up by 21%. Reported flaring increased by 125% in 2018 and by 28% in the first half of 2019. Reported venting increased by 47% in 2018 and, due to a dramatic decrease by one major operator, fell by 23% in the first half of 2019. Statewide, 2.1% of gas production was reported vented and flared in both 2018 and the first half of 2019. See also Venting/Flaring Report Tables 1 and 2 for additional information and analysis regarding total associated gas venting and flaring.

Recent reporting by the Houston Chronicle highlights these trends:

Methane emissions and pollution in the booming Permian Basin likely hit a new record high in the second quarter after taking a small, but surprising, dip early this year, according to a new study. [This] is more than triple the amount of pollution and waste from just two years ago, according to the Norwegian research firm Rystad Energy. . . . The report estimates that the volumes of methane from natural gas burned off or vented into the atmosphere averaged of 663 million cubic feet per day in the second quarter ... For context, flaring in the Permian was less than 200 million cubic feet a day in mid-2017 and was less than 20 million cubic feet daily at the beginning of 2011 before the recent Permian boom took off.

“Permian gas flaring hits new record highs for 'widespread waste,' pollution.” The Houston Chronicle, June 4, 2019

<https://www.houstonchronicle.com/business/energy/article/Permian-methane-emissions-back-on-the-rise-after-14412700.php>

**Table 1: Total Reported Venting and Flaring: Change 2017-2019 (mcf) (Source: OCD C-155 data see**

<http://www.emnrd.state.nm.us/OCD/statistics.html>)

January – June (mcf)	2017	2018	2019	17-18 % change	18-19 % change
<b>Flared</b>	6,777,979	13,146,398	16,791,319	94%	28%
<b>Vented</b>	1,092,445	1,864,133	1,436,580	71%	-23%
<b>Vented+Flared</b>	7,870,424	15,010,531	18,227,899	91%	21%
<b>Gas Production</b>	630,088,033	705,510,340	855,313,871	12%	21%
<b>% of gas production</b>	1.2%	2.1%	2.1%		
<b>Full Year (mcf)</b>	2017	2018	17-18 % change		

<b>Flared</b>	14,886,176	33,421,502	125%
<b>Vented</b>	2,123,438	3,115,734	47%
<b>Vented+Flared</b>	17,009,614	36,537,236	115%
<b>Gas Production</b>	1,296,993,949	1,503,246,867	
<b>% of gas production</b>	1.3%	2.4%	

Table 2 shows that reported venting and flaring rates are consistently higher in the NM Permian than they are in the San Juan Basin. This is not surprising since the San Juan Basin has a far greater proportion of natural gas wells, and, presumably, Operators conduct extensive infrastructure planning to ensure that wells are connected to gathering systems and have adequate processing capacity to move produced gas to market. It is important to note that the C-115 data may not include venting and flaring during completion and production testing, possibly undercounting the amount of venting and flaring actually occurring in the San Juan Basin.

(See Exhibit 1 at the end of this paper for conversion into metric tons.)

**Table 2: Reported venting and flaring as a percent of total gas production by basin: 2017-2019 (mcf) (Source: OCD C-155 data see <http://www.emnrd.state.nm.us/OCD/statistics.html>)**

2019 January-June							
Basin	Gas Production	Flared	% Flared	Vented	% Vented	Flared + Vented	% V/F
Permian	564,945,638	16,746,992	3.0%	1,413,178	0.3%	18,160,170	3.2%
San Juan	283,270,130	44,327	0.0%	23,402	0.0%	67,729	0.0%
Other	7,094,031	-		-		-	
<b>Grand Total</b>	<b>855,309,799</b>	<b>16,791,319</b>	<b>2.0%</b>	<b>1,436,580</b>	<b>0.2%</b>	<b>18,227,899</b>	<b>2.1%</b>
2018 January-June							
Basin	Gas Production	Flared	% Flared	Vented	% Vented	Flared + Vented	% V/F
Permian	404,123,297	12,949,526	3.2%	1,816,922	0.4%	14,766,448	3.7%
San Juan	292,276,293	196,872	0.1%	47,211	0.0%	244,083	0.1%
Other	9,110,750	-		-		-	
<b>Grand Total</b>	<b>705,510,340</b>	<b>13,146,398</b>	<b>1.9%</b>	<b>1,864,133</b>	<b>0.3%</b>	<b>15,010,531</b>	<b>2.1%</b>
2017 January-June							
Basin	Gas Production	Flared	% Flared	Vented	% Vented	Flared + Vented	% V/F
Permian	324,512,815	6,506,095	2.0%	662,985	0.5%	7,169,080	2.2%
San Juan	295,739,969	271,884	0.1%	429,460	0.1%	701,344	0.2%
Other	9,835,249						
<b>Grand Total</b>	<b>630,088,033</b>	<b>6,777,979</b>	<b>1.1%</b>	<b>1,092,445</b>	<b>0.2%</b>	<b>7,870,424</b>	<b>1.2%</b>
2018 Full year							
Basin	Gas Production	Flared	% Flared	Vented	% Vented	Flared + Vented	% V/F
Permian	889,318,021	32,684,460	3.7%	3,047,930	0.3%	35,732,390	4.0%

<b>San Juan</b>	595,686,659	737,042	0.1%	67,804	0.0%	804,846	0.1%
<b>Other</b>	18,097,587	-		-		-	
<b>Grand Total</b>	<b>1,503,102,267</b>	<b>33,421,502</b>	<b>2.2%</b>	<b>3,115,734</b>	<b>0.2%</b>	<b>36,537,236</b>	<b>2.4%</b>
<b>2017 Full year</b>							
<b>Basin</b>	<b>Gas Production</b>	<b>Flared</b>	<b>% Flared</b>	<b>Vented</b>	<b>% Vented</b>	<b>Flared + Vented</b>	<b>% V/F</b>
<b>Permian</b>	679,745,262	14,280,729	2.1%	1,583,845	0.2%	15,864,574	2.3%
<b>San Juan</b>	597,718,136	605,447	0.1%	539,593	0.1%	1,145,040	0.2%
<b>Other</b>	19,530,551					-	
<b>Grand Total</b>	<b>1,296,993,949</b>	<b>14,886,176</b>	<b>1.1%</b>	<b>2,123,438</b>	<b>0.2%</b>	<b>17,009,614</b>	<b>1.3%</b>

Operators vary widely in the amount of production they report vented and flared, as shown in Table 3, with some reporting 100% methane waste and others reporting zero waste. Among major producers, many report high rates of venting and flaring, ranging from 10% to 70%. Some of these differences, particularly reports of zero volumes of venting or flaring, may be due to reporting discrepancies rather than real differences between operators. Even so, there is clearly substantial variation in venting and flaring rates across operators. While location and well production are factors, it also appears likely that some operators are more successfully capturing more of their produced gas, and infrastructure planning is likely to be playing a role in this. See also Venting/Flaring Report Table 3 for additional information and analysis regarding variation in the amount of production operators report as vented or flared.

**Table 3: 2019 reported V/F data by company ranked by percent V+F in descending order (mcf)**  
**Companies numbered in descending order of gas production (Source: OCD C-155 data see**  
<http://www.emnrd.state.nm.us/OCD/statistics.html>)

<b>Company</b>	<b>Flared</b>	<b>% Flared</b>	<b>Vented</b>	<b>% Vented</b>	<b>Vented + Flared</b>	<b>% V+F</b>	<b>Gas Production</b>
<b>22</b>	41,611	100%			41,611	100%	41,611
<b>34</b>	6,177	100%			6,177	100%	6,177
<b>36</b>	2,747	100%			2,747	100%	2,747
<b>40</b>		0%	151	100%	151	100%	151
<b>41</b>		0%	150	100%	150	100%	150
<b>61</b>	13	100%			13	100%	13
<b>62</b>	9	100%			9	100%	9
<b>50</b>		0%	9,683	94%	9,683	94%	10,297
<b>57</b>		0%	557	87%	557	87%	643
<b>51</b>		0%	3,118	79%	3,118	79%	3,959
<b>7</b>	1,064,029	67%			1,064,029	67%	1,594,741
<b>17</b>	107,650	43%			107,650	43%	252,803
<b>27</b>	27,929	38%			27,929	38%	74,156
<b>35</b>	5,608	28%			5,608	28%	20,307
<b>49</b>		0%	18,794	27%	18,794	27%	69,128
<b>11</b>	785,810	27%			785,810	27%	2,950,123
<b>46</b>		0%	132,888	26%	132,888	26%	507,060
<b>65</b>		0%	31	24%	31	24%	127

24	35,117	20%			35,117	20%	175,531
13	551,886	20%			551,886	20%	2,765,155
4	1,418,580	17%	121,443	1%	1,540,023	18%	8,397,349
26	28,974	13%	421	0%	29,395	14%	217,678
19	61,788	12%			61,788	12%	511,951
15	231,469	12%			231,469	12%	1,959,823
10	912,654	10%	166,101	2%	1,078,755	12%	9,198,417
2	1,541,514	10%	109,856	1%	1,651,370	11%	15,266,940
3	1,470,907	10%	21,855	0%	1,492,762	10%	14,387,730
21	50,568	9%			50,568	9%	567,256
53		0%	1,856	7%	1,856	7%	25,989
18	90,515	4%	73,000	3%	163,515	7%	2,423,931
20	51,999	6%			51,999	6%	909,746
1	2,250,606	4%			2,250,606	4%	55,888,477
5	1,401,131	4%			1,401,131	4%	39,379,314
12	594,823	3%			594,823	3%	17,259,354
14	366,909	3%			366,909	3%	11,726,775
29	19,529	3%			19,529	3%	636,929
60		0%	169	3%	169	3%	6,407
42		0%	621,981	3%	621,981	3%	24,305,442
16	199,494	2%	1,429	0%	200,923	3%	7,984,513
33	8,825	2%			8,825	2%	364,740
47		0%	110,758	2%	110,758	2%	4,765,409
32	11,411	2%			11,411	2%	576,454
23	36,268	2%			36,268	2%	2,147,384
30	14,611	2%			14,611	2%	911,201
9	999,721	1%			999,721	1%	72,319,073
8	1,042,110	1%			1,042,110	1%	81,135,258
6	1,289,238	1%			1,289,238	1%	114,654,079
54		0%	1,529	1%	1,529	1%	143,801
48		0%	21,788	1%	21,788	1%	3,319,713
38	2,073	1%			2,073	1%	353,476
66		0%	14	0%	14	0%	3,684
25	31,914	0%			31,914	0%	14,574,999
39	45	0%			45	0%	23,362
37	2,094	0%			2,094	0%	1,370,442
31	12,413	0%	6,304	0%	18,717	0%	16,696,358
28	20,550	0%	7,365	0%	27,915	0%	37,802,026
63		0%	63	0%	63	0%	87,969
58		0%	449	0%	449	0%	687,356

59		0%	379	0%	379	0%	2,052,483
56		0%	696	0%	696	0%	3,977,391
64		0%	63	0%	63	0%	676,334
55		0%	1,281	0%	1,281	0%	42,120,791
52		0%	2,408	0%	2,408	0%	166,477,967

In addition, the rates vary over time, with several major producers doubling or tripling the amount of gas flared so far in 2019.

**Table 4: 2018 and 2019 reported venting and flaring change by operator (Jan-June) (Source: OCD C-155 data see <http://www.emnrd.state.nm.us/OCD/statistics.html>)**

Flared (January - June)			
Company	2018	2019	Percent Change '18-'19
1	2,207,775	2,250,606	2%
2	494,948	1,541,514	211%
3	1,302,579	1,470,907	13%
4	685,554	1,418,580	107%
5	816,429	1,401,131	72%
6	516,427	1,289,238	150%
7	300,128	1,064,029	255%
8	1,915,770	1,042,110	-46%
9	1,156,207	999,721	-14%
10	297,487	912,654	207%
11	197	785,810	398788%
12	1,161,496	594,823	-49%
13	331,476	551,886	66%
14	461,156	366,909	-20%
15	258,047	231,469	-10%

Vented (January - June)			
Company	2018	2019	Percent Change '18-'19
42	806,124	621,981	-23%
10	791,003	166,101	-79%
46	26,367	132,888	404%
4	6,191	121,443	1862%
47		110,758	X
2	135,473	109,856	-19%
18		73,000	X
3	1,353	21,855	1515%



48	31,317	21,788	-30%
49		18,794	X
50	9,835	9,683	-2%
28	10,605	7,365	-31%
31	17,231	6,304	-63%
51	2,357	3,118	32%
52		2,408	X

The data above represent the percentage of venting and flaring based on total gas production, including production from gas wells, which generally have little to no flaring. With respect to venting and flaring that might be avoided through improved infrastructure planning, it is more relevant to look at venting and flaring of associated gas from oil wells, which occur at significantly higher rates. As shown in Table 5, in the Permian, a reported 5.2% of associated gas was vented and flared in 2018, while 4.2% was vented and flared in the first half of 2019.

**Table 5: Reported venting and flaring % of production, oil wells only (mcf) (Source: OCD C-155 data see <http://www.emnrd.state.nm.us/OCD/statistics.html>)**

	total gas production	oil well gas production	total gas production	oil well gas production	total gas production	oil well gas production
	Permian		San Juan		State Wide	
	Jan-June					
<b>2019</b>	3.2%	4.3%	0.0%	0.4%	2.1%	4.2%
<b>2018</b>	3.7%	4.8%	0.1%	1.3%	2.1%	4.6%
<b>2017</b>	2.2%	2.9%	0.2%	4.2%	1.2%	3.0%
	Full Year					
<b>2018</b>	4.0%	5.4%	0.1%	2.3%	2.4%	5.2%
<b>2017</b>	2.3%	0.3%	0.2%	3.1%	1.3%	3.1%

**What are the data gaps in quantifying emissions/waste for this equipment?**

Emissions from smaller operators that emit less than 25,000 metric tons CO2e are not captured under the GHGRP.

There are also significant gaps in the volumes of gas reported as vented and flared through the C-115 forms. In a Notice to Operators in 2017, OCD “determined that not all Operators are following the requirement to report flared and vented volumes. Out of 603 well Operators active in the state, only 51 Operators are reporting volumes using the “V” and “F” code. It is very important that all Operators in New Mexico report flared and vented volumes since part of the evaluation will help determine any policy or requirements setting goals for reduction of flared gas. We urge all companies to work with their operations and production accounting groups to ensure proper production reporting.”

Notice to Oil and Gas Operators, Vented & Flared Volumes Reporting Communication, March 8, 2017. Available at <http://www.emnrd.state.nm.us/OCD/documents/20173-8NoticetoOperators.pdf>

Another significant gap in the data is identification of the amount of flaring that is authorized under NMAC 19.15.18.12 (60 days following completion) or under the Form C-129s Exception to No-Flare Rule. For the latter, information is needed on the extent to which operators have obtained repeated exceptions to continue to flare for long period of time.

There is currently no information publicly available about the role that New Mexico's current gas capture planning requirement has played in facilitating the flow of information between producers and midstream companies and resulting effects on the volumes of vented and flared associated gas.

### **Economic Description of the Process or Equipment:**

What is the per unit cost of the equipment or the costs associated with the process?

n/a

What are the annualized operating costs for the equipment or costs associated with the process?

n/a

If the equipment or process is powered, what are the costs?

n/a

What are the maintenance and repair costs for existing or new equipment?

n/a

### **Existing Reduction Strategies:**

How has industry reduced emissions/waste from this equipment or process historically?

New Wells:

See state/federal discussion below

Existing Wells:

See state/federal discussion below

How have the emission/waste reductions been measured?

How have states and the federal government reduced emissions/waste from this equipment or process historically? In addition, please identify voluntary reductions achieved whether or not they were in response to a regulatory action/requirement.

In response to public concern about substantial increases in venting and flaring, i.e., waste, of associated gas accompanying the growth of drilling for oil in shale formations in the period 2014-2016, several states and the federal government adopted requirements for gas capture planning. The requirements were intended to strengthen the infrastructure planning process by ensuring that producers: (1) evaluate and acquire gathering and processing capacity prior to well development; and (2) communicate expected volumes, location and timing of production to midstream companies to facilitate timely investment in expanded capacity. Continued growth of venting and flaring in the New Mexico Permian and other shale-oil producing regions of the country suggest that additional improvements are needed for gas capture planning to reach its full potential.

North Dakota pioneered requirements for producers to prepare gas capture plans and coordinate with midstream companies to reduce wasteful venting and flaring. In 2014, the state adopted a proposal developed by the North Dakota Petroleum Council (“State moves to capture 90% of flared gas by 2020”, Energy Wire, July 2, 2014 <https://www.eenews.net/energywire/stories/1060002259>). The North Dakota rule requires that gas capture plans accompany all Applications for Permit to Drill (Order 24665, available at <https://www.dmr.nd.gov/oilgas/or24665.pdf>). Detailed instructions for the contents of the plan were issued in a May 8, 2014 Letter to Operators from the North Dakota Oil and Gas Division (Available at <https://www.dmr.nd.gov/oilgas/Gas%20Capture%20Plans%20Required%20on%20All%20APD's%20050814.pdf>). Gas Capture Plans must include information about well location and anticipated production, the location and capacity of existing pipeline systems, current levels of flaring, and producers and midstream gas gathering companies must meet semi-annually. The North Dakota rule also requires operators to develop Gas Capture Plans for “increased density, temporary spacing, and proper spacing cases.” (See Order 24665).

Wyoming adopted a gas capture plan requirement in April, 2016. The WY requirements are significantly less detailed than North Dakota’s, requiring only information about gas gatherer(s) available to provide take-away capacity and available processing plant capacity. (Wyoming Administrative Code Chapter 3 Section 39.H <https://docs.google.com/a/wyo.gov/viewer?a=v&pid=sites&srcid=d3lvLmdvdxvaWwtYW5kLWdhc3Rlc3R8Z3g6NzE2ZjM3ODg3NmU5ZWQzYg>

New Mexico adopted a requirement for producers to develop gas capture plans for all new drilling permits on April 8, 2016. Notice to Operators, October 19, 2015 (Notice to Operators, April 8, 2016. Available at <http://www.emnrd.state.nm.us/OCD/documents/20164-25GasCapturePlan.pdf>). The requirements were developed by a New Mexico Gas Capture Plan Committee established in late 2015 to review activities related to venting and flaring of natural gas and consisting of representatives from state and federal agencies and operators including Agave, Concho, Conoco-Phillips, Devon, Mack, Oxy, Synergy, and WPX. The stated goal for gas capture planning was “to reduce natural gas emission[s].” A plan template was adopted requiring Operators to “outline actions to be taken by the Operator to reduce well/production facility flaring/venting for new completion[s] (new drill, recomplete to new zone, re-frac) activity.” Information required in a plan includes, for each well covered by the plan, expected production, planned volumes to be vented or flared (in conjunction with the No-Flare exemption), and identification of the Gas Transporter, gathering system to be connected to if one is in place, miles of pipeline required, and the processing plant where the gas will be processed. Operators are required to “provide (periodically) to Gas Transporter a drilling, completion, and estimated first production date for wells that are scheduled to be drilled in the foreseeable future,” and “Operator and Gas Transporter [are to] have periodic conference calls to discuss changes to drilling and completion schedules.” The plan template also includes the statement, presumably affirmed when submitted, that

“Based on current information, it is Operator’s belief the system can take this gas upon completion of the well’s.” The Notice states that these requirements apply to State, Fee, Federal, & Tribal wells.

Pennsylvania requires the use of a pigging device with 95% control if emissions are 200 tpy of CH<sub>4</sub>, or 2.7 TPY of VOC. If emissions are less than these thresholds, operators must use best management practices to minimize liquids and emissions.<sup>[1]</sup> In Ohio, operators must use an add-on pigging control which includes flare or vapor recovery to limit VOC emissions to 0.27 tpy, on average, over a rolling 12-month period.<sup>[2]</sup>

<sup>[1]</sup> Department of Environmental Protection, Air Quality Permit Exemption 38, available at <http://www.elibrary.dep.state.pa.us/dsweb/Get/Document-96215/275-2101-003.pdf>

<sup>[2]</sup> Ohio GPs for compressor stations, available at <http://epa.ohio.gov/dapc/genpermit/ngcs.aspx>

The Bureau of Land Management adopted a waste minimization planning requirement in its 2016 methane waste prevention rule, *Waste Prevention, Production Subject to Royalties, and Resource Conservation; Final Rule*, 81 Fed. Reg. 83,008 (Nov. 18, 2016) (<https://www.federalregister.gov/documents/2016/11/18/2016-27637/waste-prevention-production-subject-to-royalties-and-resource-conservation>). Waste minimization plans were required to accompany Applications for Permit to Drill for federal oil wells to “explain how the operator plans to capture associated gas upon the start of oil production.” Failure to submit a complete and adequate plan was grounds for denying or disapproving the APD. Information required in the plan included expected completion and production dates and production rates, identification of the intended destination gas pipeline or, alternatively, information about pipeline systems in the field where the well would be located, and identification of the intended destination or nearest processing plant. Operators were also required to include information about all venting and flaring in the field where the well would be located. The rule also required “certification that the operator has provided one or more midstream processing companies with information about the operator’s production plans.” These requirements were subsequently rescinded by BLM in *Waste Prevention, Production Subject to Royalties, and Resource Conservation; Rescission or Revision of Certain Requirements; Final Rule*, 83 Fed. Reg. 49,184 (Sept. 28, 2018).

<https://www.federalregister.gov/documents/2018/09/28/2018-20689/waste-prevention-production-subject-to-royalties-and-resource-conservation-rescission-or-revision-of>

BLM’s 2018 rescission of the 2016 Methane Waste Rule is the subject of ongoing litigation. Of note, the preamble to the 2016 Methane Waste Rule also, in response to requests for integration of front-end planning requirements into the rule, stated the following:

The BLM already has land use planning and NEPA tools and processes in place that can be used to help achieve the specific goals of this rulemaking—to reduce the wasteful and environmentally harmful loss of gas through venting, flaring, and leaks. The BLM conducts NEPA analyses for both regional planning decisions and project level decisions. These analyses take a hard look at the direct effects, indirect effects, and cumulative effects of the proposed federal action on various resources during the land use planning or project approval process, such as the effects on wildlife, air quality, or recreation opportunities. The BLM’s NEPA analyses also quantify GHG emissions associated with the proposed planning decision alternatives under consideration. In particular, the land use planning and NEPA processes for new RMPs and MLPs provide important opportunities to consider the effects of oil and gas development over a larger area and to optimize planned development to minimize impacts from venting and flaring, among other activities. The planning process gives the BLM the opportunity to consider how a specific land management plan could address the timing and location of development of oil and gas and related infrastructure, such as pipelines, and the projected consequences of such decisions in terms of the quantities of vented and flared gas and the impacts associated with those emissions.

81 Fed. Reg. 83,008, 83040.

Both the North Dakota and 2016 BLM gas capture planning provisions also required information about volumes of venting and flaring from existing wells in the field where the proposed well would be located to provide a more holistic picture of methane waste, flag current capacity constraints, and help identify opportunities to aggregate production volumes to justify new gathering system infrastructure investment. Because midstream pipelines, compression and processing facilities are systems designed to serve many wells, a well-by-well approach to planning and approvals can provide an incomplete view of the costs to minimize waste. Colorado has adopted a rule providing for Comprehensive Drilling Plans wherein operators identify “all foreseeable oil and gas activities in a defined geographic area, facilitate discussions about potential impacts, and identify measures to minimize adverse impacts” including methane emissions. Information to be submitted in these plans include “all proposed oil and gas facilities to be installed within the area covered by the Comprehensive Drilling Plan over the time of the Plan and the anticipated timing of the installation.” Colorado Rules and Regulations 216 Comprehensive Drilling Plans. See <https://cogcc.state.co.us/documents/reg/Rules/LATEST/200Series.pdf>

**What are examples of process changes/modifications that reduce or eliminate emissions/waste from this equipment or process?**

In addition to better gas capture planning, other potential modifications include:

1. Oil and gas lessees and operators, in their proposals for well spacing and density rules, and in applications seeking to intensify well density and spacing, could be required to estimate surface loss of natural gas as complement to estimates regarding underground recovery efficiency and to identify infrastructure investment and other actions they will take across the oil and gas pool to prevent surface waste. This would provide a basis for OCD to consider and impose conditions to minimize surface waste in association with spacing and density decisions.
2. Proposals for unitization or unit agreements, intended to ensure more orderly and efficient development of leases within a given field, could also include plans to better synchronize production from unitized fields with midstream oil and gas operations. Operators could elevate surface waste management and not defer consideration of need/opportunity to prevent waste to the drilling stage, where field-level opportunities to prevent waste may be lost.
3. Operators could package into a single application all planned/foreseeable drilling/infrastructure approval requests anticipated over a 6- to 12-month time period within a given field or unit and based on geographic proximity or potential use of shared infrastructure such as gathering systems, compressor stations, or processing facilities. This would facilitate more holistic decision-making across an entire field/unit (or, at least, an area larger than the footprint of an individual well pad), inclusive of existing oil and gas wells that may be operating at lower production pressures than new wells.

**Technology Alternatives:**

List of technology alternatives with link to information or contact information for the company/developers.				
Name/Description of Technology	Link (and contact info for company if available)	Availability	Feasibility	Cost Range (choose one)
		In use <u>or</u> in development		Low Medium High
n/a				

What technology alternatives exist to reduce or detect emissions? Please list all alternatives identified along with contact information for further investigation of this technology or process.

n/a

What are the pros and cons of the alternatives?

n/a

What is needed and available for new wells?

n/a

What is needed and available for existing wells?

n/a

What technology alternatives exist for this equipment or process itself?

n/a

What are the pros and cons of the alternatives?

n/a

## Costs of Methane Reductions:

What is the cost to achieve methane emission reductions?

Gas capture planning is already required. Costs from deploying onsite capture or use equipment, re-injecting gas, and/or delaying development of new wells to better align with gathering and/or processing infrastructure development would be associated with requirements to limit venting and flaring rates or volumes, rather than attributed to requirements to improve the infrastructure planning process. Other process changes, for example multi-well “Comprehensive Drilling Plans” or “Master Development Plans” and integration of methane waste capture and marketing provisions in unitization agreements make use of existing oil and gas development decision points. While they impose new requirements that presumably come with additional planning and analytical costs, a front-end investment in planning would presumably lead to additional natural gas capture and thus boost sales and profits. In addition, multi-well “Comprehensive Drilling Plans,” “Master Development Plans,” and unitization agreements are intrinsically designed to promote orderly and efficient development of resources—i.e., they are a wise investment that pays dividends through orderly and efficient resource development.

For reducing emissions from gathering station blowdowns, the Synapse report estimates installing technology for Transmission Station Venting -Redesign Blowdown Systems/ESD Practices to have a unit cost of \$3.84 per mcf of reduced methane and \$199.68 per tonne of reduced methane.<sup>[3]</sup> The Synapse report also estimates the cost of installing LDAR (weighted average) for gathering stations to be \$7.35 per mcf of reduced methane and \$382.20 per tonne of reduced methane.<sup>[4]</sup>

<sup>[1]</sup> Synapse, Cost-Effectiveness of Comprehensive Oil and Gas Emissions Reduction Rules in New Mexico (Sept. 2019), available at <http://blogs.edf.org/energyexchange/files/2019/09/Synapse-Methane-Cost-Benefit-Report.pdf>

<sup>[1]</sup> *Id.*

What would be the implementation cost?

For new wells?

n/a

For existing wells?

n/a

Are there low-cost solutions available?

Yes, improved infrastructure planning and coordination is very low cost.

If a solution is high-cost, why is that the case?

n/a

Are there additional technical analyses needed to refine benefits/costs estimates?

Given the very low cost of and fairly broad agreement on the value of improving infrastructure planning, as well as the difficulty in directly measuring results, it does not appear that this would be a high priority area of focus for refining benefit/cost estimates, relative to other technologies and processes under consideration.

### 3. IMPLEMENTATION

For each piece of equipment or process, please consider the following questions and add other relevant information. If relevant, please identify if the answers are different for large company and small company requirements or are different for well type or basin.

#### Implementation Feasibility:

What is the feasibility of implementation (availability of required technology or contractors, potential permitting requirements, potential for innovation)?

Implementation requires gathering information and developing a plan, both of which are straightforward activities. "In the past, Operators have objected to proposals for gas capture plans with detailed information regarding gathering system availability, asserting that Operators do not have access to some of the information that would be necessary to develop such plans. Specifically, Operators have objected to including the following information: —the name and location of the nearest gas processing plant and the intended destination gas processing plant; —maximum current daily capacity, current throughput, and anticipated daily capacity of the gas pipeline to which the operator plans to connect; and

—any plans known to the operator for expansion of pipeline capacity in the area of the well.

BLM believed that Operators would generally be able to obtain such information from midstream companies. See BLM, *BLM's Responses to Public Comments on Final Rule*, 171-172 (2016).

The commercial agreements between E&P and midstream operators typically dictate what information can and cannot be shared. E&P operators may be constrained to share or provide information during the APD process. Commercial contracts typically restrict the sharing of sensitive or proprietary information, with respect to midstream infrastructure. The constraints could include not knowing downstream details of midstream operator's pipeline or facilities, or details around pipeline or gas plant capacities could be proprietary and not shared with the E&P operators. These details could include information to E&P or midstream operator's competitors and makes it difficult, to share in a public process.

Midstream operators, by virtue of iterative communications with E&P sector operators and completion of hydraulic analysis of pipeline and compressor infrastructure, may be in an excellent position to complement E&P gas capture planning. This could involve an aggregation of reasonably foreseeable regional volumes of natural gas to provide regulators with information pertinent to infrastructure planning across the value chain that nonetheless complies with any legal restrictions on the sharing of sensitive or proprietary information. Also, commercial agreements are adopted by E&P and midstream operators for their mutual benefit and may, of course be modified. To the extent that such commercial agreements may constrain information sharing necessary to comply with any regulatory requirements established for gas capture plans and infrastructure planning, those provisions of the agreements are likely unenforceable and certainly may be changed. Furthermore,

What is the useful life of equipment?

n/a

What are the maintenance and repair requirements for equipment required for methane reduction?

n/a

How would emissions be detected, reductions verified and reported?

## 4. CHALLENGES AND OPPORTUNITIES TO ACHIEVE METHANE REDUCTION IN NEW MEXICO

For each piece of equipment or process, please consider the following questions and add other relevant information. If relevant, please identify if the answers are different for large company and small company requirements or are different for well type or basin.

What regulatory gaps exist for this equipment or process? Are there regulatory gaps filled by the proposed implementation?

Given continuing increases in venting and flaring in states with gas capture plan requirements, this measure has not yet reached its potential to reduce methane waste. See, for example,



"Flaring reaches record high amid pipeline, gas plant shutdowns," Bismarck Tribune, August 15, 2019

[https://bismarcktribune.com/bakken/flaring-reaches-record-high-amid-pipeline-gas-plant-shutdowns/article\\_610d6c94-6b03-57df-b5b2-9a25a82d9271.html](https://bismarcktribune.com/bakken/flaring-reaches-record-high-amid-pipeline-gas-plant-shutdowns/article_610d6c94-6b03-57df-b5b2-9a25a82d9271.html)

"Wyoming Ranks Third Nationally in Natural Gas Flaring," Wyoming Public Media, September 24, 2019

[https://www.wyomingpublicmedia.org/post/wyoming-ranks-third-nationally-natural-gas-flaring?utm\\_source=1500+CWP+List+Daily+Clips+and+Updates&utm\\_campaign=29104083dd-](https://www.wyomingpublicmedia.org/post/wyoming-ranks-third-nationally-natural-gas-flaring?utm_source=1500+CWP+List+Daily+Clips+and+Updates&utm_campaign=29104083dd-)

[EMAIL\\_CAMPAIGN\\_2019\\_09\\_24\\_07\\_51&utm\\_medium=email&utm\\_term=0\\_4369a4e737-29104083dd-75462645#stream/0](https://www.wyomingpublicmedia.org/post/wyoming-ranks-third-nationally-natural-gas-flaring?utm_source=1500+CWP+List+Daily+Clips+and+Updates&utm_campaign=29104083dd-EMAIL_CAMPAIGN_2019_09_24_07_51&utm_medium=email&utm_term=0_4369a4e737-29104083dd-75462645#stream/0)

"Permian gas flaring hits new record highs for 'widespread waste,' pollution." The Houston Chronicle, June 4, 2019

<https://www.houstonchronicle.com/business/energy/article/Permian-methane-emissions-back-on-the-rise-after-14412700.php>

According to research conducted in 2017, compliance with the NM gas capture plan requirement has been uneven.

### APD's and Gas Capture Plans Submitted 9/18/17–11/5/17

Total APDs	GCP submitted		GCP not submitted	
286	132	46%	154	54%

### APD's and Gas Capture Plans By Mineral Owner

	Total APDs	GCPs submitted		GCPs not submitted	
State	100	19	19%	81	81%
Federal	157	110	70%	47	30%
Private	29	3	10%	26	90%

"Curbing Methane Pollution and Waste: New Mexico's Problem and Opportunity," presentation by EDF to the Water and Natural Resources Interim Committee, November 20, 2017 (see Exhibit 4).

A key regulatory gap in gas capture planning is that plans have not been adequate to provide certainty that, at least for development oil wells, takeaway capacity will be in place once the well has been completed and begins producing. Redesigning the gas capture plan template to require additional information and assurance of projected outcomes is needed to close this regulatory gap. For adequate planning, more detailed information is needed on when the proposed well is expected to be completed and the anticipated volume of production, as well as the anticipated capacity of the gathering system to which the operator intends to connect. To ensure results – i.e., that gathering capacity is consistently available when and where it is needed – requires more certainty up front that takeaway capacity will be available when new wells begin production, such as documentation of contracts or agreements indicating that the operator has obtained firm takeaway capacity from a midstream company. To enhance compliance, plans should be a mandatory element of the drilling permit approval process; i.e., APD approvals should be deferred or denied if plans are inadequate. To address changed circumstances, Operators should be required to update plans when material changes occur, such as if drilling is delayed or more information becomes available about well characteristics.

The current gas capture plan requirements also fail to require operators to consider alternatives to venting or flaring where gathering capacity is not available. See the MAP Report on Venting and Flaring for discussion of this issue.

In addition to gas capture planning by operators, planning requirements could also be developed for midstream companies to “plan backwards/upstream” when seeking state approvals, i.e., that they have reviewed gas capture plans for new wells in the locations to be served by their projects. For example, a gas capture planning requirement could be adopted by the State Land Office for ROW applications and by NMED for air permit applications. These plans could also be shared with operators to inform their planning.

A gap also exists in providing information about other wells in the vicinity of the proposed well, both existing wells that may be venting or flaring and new wells that are planned to be developed by the Operator, to provide midstream companies with a more complete picture of production that may be available to be aggregated to support takeaway capacity. This information is not available in piecemeal, well-by-well drilling applications. This gap could be addressed by requirements for Operators to package into a single application all planned/foreseeable drilling/infrastructure approval requests anticipated over a 6- to 12-month time period within a given field or unit based on geographic proximity or potential use of shared infrastructure such as gathering systems, compressor stations, or processing facilities. The U.S. Bureau of Land Management, in its [Gold Book](#) (see p. 8), provides for a “master development plan” type approach that illustrates the utility of moving from well-by-well permitting to multi-well permitting in a developing field. This approach is echoed in Bureau of Land Management [Information Bulletin No. 2018-061 \(June 26, 2018\)](#) which provides, in section III.A., for the consolidation of multiple drilling permit applications in a single Master Development Plan accompanied by a single environmental review process (promoting efficiencies and streamlining the process relative to APD-specific environmental reviews). In accord with this BLM guidance, the Master Development Plan can also encompass sundry notices and proposed oil & gas rights-of-way. If coupled with requirements that such plans account for infrastructure planning to reduce methane pollution and waste, this approach to drilling permits would create incentives for industry to conduct planning, investment, and permitting activities in a more efficient and comprehensive manner. Under this approach OCD would not approve multiple drilling requests in one fell swoop that would fail to address site-level considerations; on the contrary, OCD would still make its drilling approval decisions on an individual-well basis, if based on an omnibus, overarching infrastructure plan. The effectiveness of this state-level comprehensive drilling plan would be optimized by considering the full life-cycle of infrastructure development in a given field or drilling unit, providing information that can be used to synchronize infrastructure development to facilitate methane capture and marketing and to understand how to best reduce the loss of methane as the field declines and its wells are eventually plugged and abandoned. In addition, comprehensive drilling plans should be designed to facilitate multi-jurisdictional coordination between OCD, BLM, SLO, and NMED and to minimize redundancies.

A regulatory gap also exists in preventing methane waste in spacing and density rules. The Oil and Gas Act, N.M. Stat. § 70-2-3, expressly provides that “surface waste” can result from the “manner of spacing.” 19.15.15 NMAC. Yet a gap currently exists in addressing surface waste management issues in OCC and OCD decision-making on well spacing and density rules. This gap could be addressed by placing “surface waste” management on an equal footing with “underground waste” management by requiring oil and gas lessees and operators to identify infrastructure investment and other actions they could take to prevent surface waste in their proposals for spacing and density, and in applications seeking to intensify well density and spacing. This would provide a basis for OCD to consider and impose conditions to minimize surface waste in association with spacing and density decisions. Well spacing and density rules set the spatial pattern of development across a particular oil and gas pool. As such, they provide an early and essential opportunity to consider ways to prevent methane waste across an entire pool.

Similarly, a gap in addressing methane waste exists in unitization or unit agreements. These agreements facilitate the orderly development and reduce the total costs of operating oil and gas fields owned by multiple lessees. They do this by consolidating and coordinating operations across all lessees under a single operator, sharing the risks and costs of development, improving the economics of production, and consolidating infrastructure. In so doing, unit

agreements set the stage for the development and approval of individual drilling permits in specific locations within an oil and gas field. Requirements to include consideration of methane waste in unitization agreements could drive better synchronization of production from unitized fields with midstream companies. Addressing waste in unitization would avoid deferring consideration of the need and opportunity to prevent waste to the drilling stage where unit-level opportunities to prevent waste may be lost. OCC and OCD could exercise authority to deny or condition unit agreements to ensure that they acknowledge and account for methane waste at the field level.

Where do conflicting priorities exist between NMED, EMNRD, and NMSLO? Are there opportunities for coordination between these agencies?

Opportunities exist for integrated data systems, information sharing/notifications, and coordinated approval processes to support achievement of each other's missions:

- SLO could provide information to OCD about planned lease sales, enabling OCD to anticipate APDs, unitization, and spacing applications
- OCD could provide information to SLO about areas with high venting or flaring rates to consider reorienting leasing to areas with more available takeaway capacity.
- OCD could provide Gas Capture Plan information to NMED about planned venting and flaring during well completion and production testing to monitor for AQ violations
- NMED could utilize C-115 venting and flaring data to monitor for AQ violations
- NMED could provide methane emissions data to support OCD verification of C-115 venting and flaring reporting

Are there existing regulations related to methane that do not address the intended purpose? Identify any unintended barriers to methane reductions/capture that may hinder proposed processes.

n/a

Other considerations or comments (e.g. particular design or technological challenges/opportunities, co-benefits, non-air environmental impacts, etc.):

There may be a need to study the end-of-life of the well infrastructure plans for wells as improperly plugged or abandoned well are not done up to standard process that ensures methane is not released. ("Measuring methane emissions from abandoned and active oil and gas wells in West Virginia"

<https://www.princeton.edu/~mauzeral/papers/Measuring%20methane%20in%20West%20Virginia.pdf>;

"Measurement of methane emissions from abandoned oil and gas wells in Hillman State Park, Pennsylvania"

<https://www.tandfonline.com/doi/figure/10.1080/17583004.2018.1443642?scroll=top&needAccess=true>)

The PHMSA Gas Transmission Integrity Management rule resulted in regulations (49 CFR Part 192, Subpart O) which specify how pipeline operators must identify, prioritize, assess, evaluate, repair and validate the integrity of gas transmission pipelines that could, in the event of a leak or failure, affect High Consequence Areas (HCAs) within the United States.

<https://www.phmsa.dot.gov/pipeline/gas-transmission-integrity-management/gas-transmission-integrity-management-gt-im-overview>

## 5. INFRASTRUCTURE - PATH FORWARD<sup>60</sup>

	OPTIONS	DESCRIPTION AND LINK TO INFORMATION IF AVAILABLE. PLEASE LIST THE BENEFIT THAT COULD BE ACHIEVED THROUGH THIS OPTION AND ANY DRAWBACKS OR CHALLENGES TO IMPLEMENTATION	EFFECTIVENESS OF COST NOW (choose one)	REPORTING, MONITORING AND RECORDING OPTIONS, INCLUDING REMOTE DATA COLLECTION	IS THIS OPTION HELPFUL IN THE SAN JUAN BASIN, PERMIAN BASIN OR BOTH
5.1	<p>Statutory/regulatory changes to allow for industry and New Mexico agencies to use third party contractors, who are approved by the State, for surveys and analysis for ROWs and other approvals. This option will help facilitate infrastructure installation.</p> <p>This type of process is currently utilized by NMOCD to help with the approval of surface waste facilities. The industry participant enters into a contract with a local New Mexico college, selected by NMOCD. The NMOCD creates a scope of work and the necessary report is created by the college. This mechanism helps reduce workload burdens on the agency and helps facilitate a timely approval, while ensuring adequate studies are performed.</p>	<p style="font-size: 48px; opacity: 0.3; transform: rotate(-30deg);">DRAFT</p>	<p>1 = Easy 5 = Hard</p> <p>1 – Easy to achieve and cost effective. However, statutory changes may be needed for NMSLO to implement this type of procedure to assist with ROWs for infrastructure needs.</p>	<p>The state would obtain copies of all the work performed and still be responsible for approving the analysis/surveys. This would allow the state to obtain more data from third-party contractors funded by industry bonding or through government contracts.</p>	Both
COMMENTS:			SUGGESTIONS TO MAKE THIS OPTION MORE WORKABLE:		

<sup>60</sup> The format of the Path Forward table evolved over the course of the meetings as the group tried to identify the best method for capturing the most useful information. As a result, there is some variation in the table headers from topic to topic in the final consolidated report.

	A. Where this option is being exercised, it should be noticed and comment allowed for in administrative policy/rule changes that do not already require a public process. [page 108]				
5.2	<p>Reform of PRC statutes to create mandatory deadlines for the approval of electric lines needed to service oil and gas facilities.</p> <p>The creation of an administrative application process for the PRC to issue timely approvals for electrical lines needed to service oil and gas facilities.</p> <p>During the MAP meetings, Xcel Energy indicated that PRC approval times for electric lines can run 18 – 24 months. Industry members indicated that they have experienced delays in ability to install electric lines to service oil and gas facilities – particularly in Southeastern, New Mexico. Creating mandatory deadlines or a shortened administrative approval process will help facilitate the installation of electric lines.</p>		3 – Moderate. Consultation would be required with the PRC and statutory reform would likely need to be supported by utility companies. If deadlines to approve lines can be imposed, this should encourage the use of electricity and result in the potential for emissions reductions.		Both, more so in Permian.
	COMMENTS:		SUGGESTIONS TO MAKE THIS OPTION MORE WORKABLE:		
5.3	<p>A Memorandum of Understanding between BLM, NMSLO, EMNRD, NMED, affected tribes, and BIA regarding ROW and infrastructure coordinated considerations.</p> <p>This MOU could help the agencies prioritize ROW approvals and discuss the timelines for these approvals. In</p>		1 – Easy. This, however, would involve agency coordination, which may create a different assessment of feasibility by each agency. If the	An MOU could also cover data sharing and data collection needs between the agencies.	Both

	particular, NMSLO and BLM may be able to work together or better share data to assist with pipeline ROW projects.		ROW process can be streamlined and coordinated, it will help with the construction of infrastructure which will impact emissions.		
	<p>COMMENTS:</p> <p>A. Ensure that this type of coordination would not alter individual agency's obligations to protect public health and the environment. [page 131]</p>		<p>SUGGESTIONS TO MAKE THIS OPTION MORE WORKABLE:</p>		
5.4	<p>Revise gas capture plan (GCP) requirements. Specify plan elements to include:</p> <ul style="list-style-type: none"> <li>--well location; expected drilling, completion, and first production date; expected volumes and pressures;</li> <li>--from multiple wells for the above if operator is planning multiple wells in same area within relevant timeframe;</li> <li>--information about the operator's other current production, and venting and flaring, in the vicinity of the proposed well;</li> <li>--identification of intended gathering system and processing facility for gas production, including pipeline size, pressure, and available capacity now and for the period over which the well is projected to produce, and plan for additional compression if needed;</li> <li>--showing/certification that the operator has communicated projected gas volumes and timing for all operations in the vicinity of the destination pipeline to</li> </ul>	<p>Compliance with comprehensive GCP requirements would improve greatly information available to midstream operators to plan their systems to align with expected gas production in a timely fashion. It would also document for OCD that the producer has obtained transportation and processing capacity for wells that are drilled at the time they go into production. See ND, BLM 2016 rules. Expanding the elements required for an adequate GCP would ensure that the operator produces a plan that results in capturing (or disposing through a means other than venting / flaring) the projected volumes of gas over the projected lifetime of the well. For operators seeking APDs for wells without a drilling schedule or sufficient information to forecast production, OCD should consider establishing a process for conditional APD approvals with requirements to update the GCP when required information is available before final drilling approval is granted.</p>	<p>LOW MODERATE HIGH</p>	<p>GCPs should be submitted electronically in machine-readable form.</p>	

	<p>the midstream company, including current venting and flaring;  --showing/certification that midstream company projects there will be available capacity to accept the projected gas production from the specified well;  --if pipeline capacity not projected to be available, specific plan for alternative gas use/disposal, with demonstration that the operator has the ability to implement such plan (e.g., if plan to reinject gas, show permit applications submitted; if plan to generate for grid, show communications with grid operator, etc.)  -measures to prevent waste over the life of the well, including additional compression and plugging and abandonment</p>				
COMMENTS:			SUGGESTIONS TO MAKE THIS OPTION MORE WORKABLE:		
5.5	Condition grant of APD on submission of adequate GCP with APD.	Conditioning grant of APD on submission of an adequate GCP provides operators a strong incentive to submit plans that identify firm transportation and processing capacity and makes the submittal of the GCPs readily enforceable with minimal state effort.	LOW MODERATE HIGH	n/a	
COMMENTS:			SUGGESTIONS TO MAKE THIS OPTION MORE WORKABLE:		
5.6	Explore opportunities for sharing information between OCD, NMED, EMNRD, affected tribes, BLM, BIA, and SLO to support permitting and approval processes and achieve methane	Information sources: SLO lease sales and ROWs Form C-115 venting and flaring data Gas Capture Plans NMED excess emissions data	LOW MODERATE HIGH	n/a	

	<p>emissions and waste reductions. For example,</p> <ul style="list-style-type: none"> <li>• SLO could provide information to OCD about lease sales and rights-of-way applications, enabling OCD to anticipate the location and timing of APD, unitization, and spacing applications</li> <li>• OCD could provide information to SLO about areas with high venting or flaring rates to consider reorienting leasing to areas with more available takeaway capacity.</li> <li>• OCD could provide Gas Capture Plan information to NMED about planned venting and flaring during well completion and production testing to monitor for AQ violations</li> <li>• NMED could utilize C-115 venting and flaring data to monitor for AQ violations</li> <li>• NMED could provide excess emissions data to support OCD verification of C-115 venting and flaring reporting</li> </ul>	<p>OCD, NMED and SLO have information that could be useful to their sister agencies. Making this information more easily available could improve agency performance in achieving methane emissions and waste reductions.</p>			
<p>COMMENTS:</p>			<p>SUGGESTIONS TO MAKE THIS OPTION MORE WORKABLE:</p>		
<p>5.7</p>	<p>OCD should commission a study of C-129 Applications for Exception to No-Flare Rule to identify the prevalence of operators and wells seeking repeated exemptions for long-term venting or</p>	<p>Form C-129s are currently part of well files as scanned documents.</p>	<p>LOW MODERATE HIGH</p>	<p>Form C-129s should be submitted electronically in machine-readable form.</p>	



	flaring. Follow-up research could look into the causes of long-term venting and flaring.				
COMMENTS:			SUGGESTIONS TO MAKE THIS OPTION MORE WORKABLE:		
5.8	OCD should issue a Notice to Operators that have reported long-term volumes of vented gas on C-115 reports requiring them to provide OCD with the reasons for such venting to support possible enforcement action	C-115 data on venting is readily available to the agency. Venting is significantly more damaging to the climate than flaring, and near-term action to prevent this form of waste and pollution will provide substantial climate benefits.	LOW MODERATE HIGH		
COMMENTS:			SUGGESTIONS TO MAKE THIS OPTION MORE WORKABLE:		
5.9	Require that well spacing/density for a given pool be set only after consideration by regulators of surface waste concerns, including by requiring that operators provide estimates of natural gas/methane potentially lost from spacing/density and actions/opportunities to prevent waste (operators already provide estimates of underground reservoir recovery efficiency). Ensures “waste” and methane reduction opportunities are considered by operators before well spacing/density pattern is set across a particular oil or gas pool and provides basis for OCD to determine that changes to well spacing/density to improve underground recovery efficiency do not cause undue or unnecessary surface waste of natural gas. At present, OCC/OCD spacing/density decisions are	Oil & Gas Act defines “surface waste” of natural gas as, in part, “resulting from the manner of spacing.” NMSA § 70-2-3(B). The Oil Conservation Commission has, of note, justified a decision between two different proposals by selecting the proposal that they believed would result in greater environmental protection and less surface waste. See OCC Order No. R-14876 (2019).	LOW MODERATE HIGH		

	typically focused on underground reservoir recovery, with surface waste issues given short shrift.				
COMMENTS:			SUGGESTIONS TO MAKE THIS OPTION MORE WORKABLE:		
5.10	Strengthen unitization agreement provisions regarding surface waste prevention, including by requiring information regarding the nature and effectiveness of infrastructure to capture and market (versus vent, flare or leak) natural gas and to better synchronize E&P sector development of that unit with midstream operations.	The model U.S. Bureau of Land Management unit agreement (see 43 C.F.R. § 3186.1) includes provisions regarding the “proper conservation of the oil and gas resources in the unitized area,” requiring information regarding the number and locations of wells, proposed order and time for such drilling, and a summary of operations and production for the previous year.” These elements provide a starting point for providing that unitization agreements, for all oil and gas resources in New Mexico, not just federal public oil and gas resources, account for surface waste of natural gas.	LOW MODERATE HIGH		
COMMENTS:			SUGGESTIONS TO MAKE THIS OPTION MORE WORKABLE:		
5.11	Comprehensive Drilling Plans/Master Development Plans/Geographic Area Plans. These would be mandated for all foreseeable oil & gas infrastructure, ensuring that regulators are afforded a more expansive picture of field-level development and avoid piecemeal review and approvals. These Plans should also be used to assess opportunities to retrofit existing infrastructure that results in vented/flared/leaked natural gas as a condition of approving new	<a href="#">Colorado Oil &amp; Gas Commission Rule 513</a> provides for “Geographic Area Plans” that “are intended to enable the Commission to adopt basin-specific rules” and are intended to cover an entire oil and gas field or geologic basin, likely encompassing the activities of multiple operators, in multiple sub-basins or drainages, over a period of ten (10) years or more.” <a href="#">Colorado Oil &amp; Gas Commission Rule 216</a> provides for voluntary “Comprehensive Drilling Plans” that can encompass multiple operators (but are more typically limited to a single operator)	LOW MODERATE HIGH		

	<p>infrastructure and ensuring that new, high-pressure wells do not “knock off” existing, lower-pressure wells within the same field. Such plans should be designed as opportunities for multi-jurisdictional engagement by OCD, SLO, BLM, and NMED.</p>	<p>and are “intended to identify foreseeable oil and gas activities in a defined geographic area, facilitate discussions about potential impacts, and identify measures to minimize adverse impacts to public health, safety, welfare, and the environment, including wildlife resources, from such activities.” The U.S. Bureau of Land Management’s “<a href="#">Gold Book</a>” also provides for “Master Development Plans” for “all or a portion of the wells proposed in a developing field” (Gold Book, p. 8). <i>See also</i> Bureau of Land Management <a href="#">Information Bulletin No. 2018-061 (June 26, 2018)</a> (providing for consolidation of multiple well applications as well as sundry notices and rights-of-way applications in a given field or area within a single Master Development Plan).</p>			
COMMENTS:		SUGGESTIONS TO MAKE THIS OPTION MORE WORKABLE:			
5.12	<p>Consider more pipeline integrity strategies including iPipe.</p> <p>iPipe (intelligent pipeline integrity program) is an industry-led consortium whose focus is to contribute to the advancement of near-commercial, emerging technologies to prevent and detect gathering pipeline leaks. The program is a direct response to North Dakota Governor Burgum’s May 2017 challenge to industry to think outside the box and apply new technology to address the challenge of eliminating pipeline leaks.</p>	<p><a href="https://www.ipipepartnership.com/">https://www.ipipepartnership.com/</a></p> <p>This unique program is currently funding approximately \$4 million in development and demonstration activities over the course of almost 4 years. As additional pipeline operators join the program as members, additional funding will be applied to pursue more technology development efforts.</p> <p>iPIPE consortium members contribute research and development funding to advance new technologies in pipeline leak detection and leak prevention. Members</p>	MODERATE HIGH		

		participate in research forum meetings, offer operating pipelines upon which new technology can be developed and improved, and have immediate access to research and development results.			
COMMENTS:		SUGGESTIONS TO MAKE THIS OPTION MORE WORKABLE:			
5.13	Work towards providing more grid power through master development plans, faster right of way acquisition for oil and gas and utility providers.	Work towards MOU with SLO, BLM, Tribes to accelerate ROW for utilities to provide grid power.	MODERATE HIGH		
COMMENTS:		SUGGESTIONS TO MAKE THIS OPTION MORE WORKABLE:			
5.14	Consider streamline permit for power generation.	Streamline permitting for onsite power generation may allow creative solutions to exist to prevent venting and flaring by both E&P operators and by midstream operators.	LOW MODERATE	As a result of the permit, this could include permitting calcs, thresholds and/or data collection to quantify or reduce venting and flaring.	
COMMENTS: A. Ensure that this type of coordination would not alter individual agency's obligations to protect public health and the environment. [page 111]		SUGGESTIONS TO MAKE THIS OPTION MORE WORKABLE:			
5.15	Portable flares for pipeline blowdowns	Consider the allowance of a portable flare to be used without permit and reported via a C-129 or C-141.	LOW MODERATE	This may require and update on the C-141 or C-129 depending on implementation.	
COMMENTS:		SUGGESTIONS TO MAKE THIS OPTION MORE WORKABLE:			
5.16	Reduce pigging emissions	Pennsylvania requires the use of a pigging device with 95% control if emissions are 200 tpy of CH <sub>4</sub> , or 2.7 TPY of VOC. If emissions are less than these thresholds, operators must use best management practices to	LOW MODERATE HIGH		

		minimize liquids and emissions. <sup>[1]</sup> In Ohio, operators must use an add-on pigging control which includes flare or vapor recovery to limit VOC emissions to 0.27 tpy, on average, over a rolling 12-month period. <sup>[2]</sup>			
COMMENTS:		SUGGESTIONS TO MAKE THIS OPTION MORE WORKABLE:			
5.17	Reduce blowdown emissions	The EPA's Natural Gas Star program recommends saving the gas from compressors and/or pipeline segments that are taken out of service for operational or maintenance purposes, thereby reducing methane emissions by depressurizing to a connected or nearby low-pressure fuel or product system. <sup>[3]</sup>	LOW MODERATE HIGH		
COMMENTS:		SUGGESTIONS TO MAKE THIS OPTION MORE WORKABLE:			

# SECTION 6, VENTING/FLARING

Discussion for MAP members on October 11, 2019

---

NOTE: The focus of this report is processes, and the associated equipment, directly related to the release or capture of methane gas. We are not requesting information on processes/equipment that are not related to the release or capture of methane gas.

## 1. DESCRIPTION OF PROCESS AND EQUIPMENT

Provide a description of the processes and/or equipment used in oil and/or gas extraction for this topic. Note that this report template will be used for all topics of the MAP review and, thus, not all questions or information may be relevant for each topic. If information is not relevant, indicate N/A. Note any differences expected for differing well types, industry sector, or basin location.

### Technical description of the process or equipment:

In the oil and natural gas industry, flaring is the controlled combustion of natural gas that can occur during drilling and completion activities, oil and natural gas field production, pipeline gas gathering, and facility processing of oil and natural gas. Flaring refers to routing natural gas from anywhere in the flow path to a device where the gas is combusted as it leaves the tip of the flare, typically elevated well above ground level.

As most sources of venting will be addressed in the other topic reports, this document focuses primarily on flaring. Also, tank vapor flaring will be discussed in other topic reports; therefore, the scope will be further limited to associated gas (casinghead gas) flaring, with some discussion of associated gas venting as well. Associated gas described in this report is raw, unprocessed gas from the separator and treater and is not marketable at the wellhead for industrial, power generation, and feedstock applications without the pipeline and gas processing infrastructure that is necessary to reduce the heating content and liquid content suitable to meet downstream pipeline specifications, although there may be other potentially un-economic ways to utilize gas at wellheads

The economics of these alternative means of gas utilization will vary.

Beginning in 2011, the Delaware Basin shale boom in southeast New Mexico resulted in a dramatic increase in oil production along with associated natural gas, which led to capacity constraints in the existing pipeline infrastructure. Since that time, oil and gas (upstream and midstream companies) have permitted significant pipeline and gas plant projects and upgrades to alleviate the constraints.

Monthly Crude Oil Production in New Mexico Since 1981

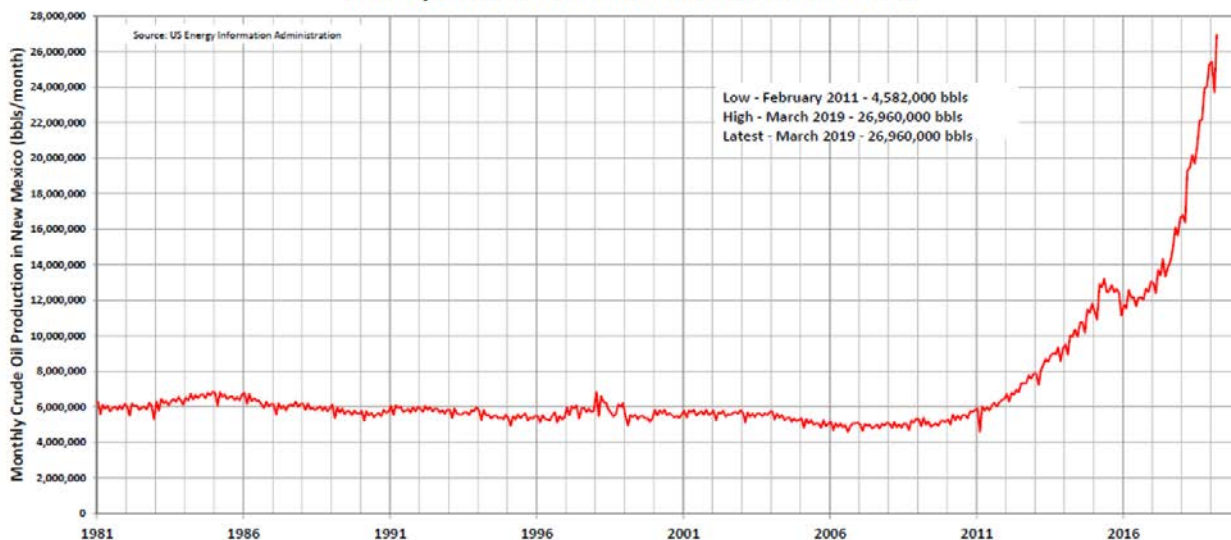

During 2015 Legislative Session, SM 29 was issued requesting EMNRD, NMED, the Indian Affairs Department, and the Department of Finance and Administration to convene a joint task force to study the economic and environmental impact of the increase in natural gas flaring and venting in New Mexico. While SM 29 requested a study to be conducted, the Senate did not allocate funding for such a study. Instead, EMNRD chose to use the committee's time to address the Oil Conservation Division's (OCD) current rules about venting and flaring.

A Gas Capture Plan Committee (GCPC) was formed in July 2015 consisting of NMOCD and Industry representatives. First meeting was held on August 19<sup>th</sup>, 2015. Below is timeline of events of the group:

- November 2015 - Implemented new "F" code for flared volumes to be reported on C-115s.
- November 2015 – The GCPC expanded to include representatives from New Mexico Environment Department (NMED), State Land Office (SLO), Bureau of Land Management (BLM), and Energy Conservation and Management Division (ECMD). The purpose is to inform and ensure that other State Departments/Agencies are working together to achieve same goal in the reduction of flaring without duplicating or conflicting each other.
- May 1, 2016 – Gas Capture Plan required to be submitted for new drill, recomple to new zone, or re-frac applications.
- November 2017 – Sec. McQueen prepared report for House Energy Committee on GCPC efforts.
- November 2017-November 2018 – monitored vented and flared volumes being reported.

Subsequent to the GCPC activities, several other flaring related agency and administration actions have occurred:

- October 5, 2018 – General Construction Permit to allow temporary flares at NOI oil and gas production facilities was issued.
- January 29, 2019 – Executive Order on addressing Climate change and Energy Waste Prevention issued by Governor Lujan Grisham.
- June 2019 – NMED and EMNRD begin statewide public stakeholder engagement meetings.
- August 2019 – NMED and EMNRD convene Methane Advisory Panel as it begins the process of developing new methane emission and flaring reduction rules.

Provide the segment(s) of the industry that the equipment or process is found:

Flares can be found throughout the production and midstream segments.

Describe how the equipment or process is used:

### Equipment

Flaring refers to routing natural gas from anywhere in the flow path to a device where the gas is combusted as it leaves the tip of the flare.

The flare system will consist of a header, stack, tip, and ignition system. Gas is sent to the flare through a header system and is combusted as it exits the flare stack at the tip. The flare tip is designed to ensure the proper mix of gas and air to achieve the proper burn efficiency. Ignition of the gas stream is through the use of a continuously burning pilot or auto-ignition system.

### Process

Flaring is an essential and necessary part of drilling and completion activities, oil and natural gas field production, pipeline gas gathering, and facility processing of oil and natural gas because of safety considerations (personnel and equipment) and its effectiveness in combusting harmful emissions (environmental). Even at the global level, an entity called the World Bank has identified certain categories where flaring is acceptable and necessary as well as acknowledged that some 'routine' flaring was to be anticipated under certain circumstances.

<http://documents.worldbank.org/curated/en/755071467695306362/pdf/106662-NEWS-PUBLIC-GFR-Gas-Flaring-Definitions-29-June-2016.pdf>

The Bank defines routine flaring "of gas at oil production facilities as flaring during normal oil production operations in the absence of sufficient facilities or amenable geology to re-inject the produced gas, utilize it on-site, or dispatch it to a market." It includes "flaring from oil/gas separators; flaring of gas production that exceeds existing gas infrastructure capacity; and flaring from process units such as oil storage tanks, tail gas treatment units, glycol dehydration facilities, produced water treatment facilities, except where required for safety reasons." The Bank is calling upon governments, development institutions, and oil companies to endorse the "Zero Routine Flaring by 2030 Initiative." <https://www.worldbank.org/en/programs/zero-routine-flaring-by-2030>.

There are several reasons why natural gas may be flared at any step during producing and processing of crude oil and natural gas. The following is a list of situations where flaring may be necessary. Data currently reported on C-115 does not provide enough detail to differentiate what would or would not constitute waste.

- Temporary flaring during drilling and completion activities or flowback/well testing.
- To protect personnel or the public from potentially unsafe conditions that would result in exceeding the maximum allowable operating pressure (MAOP) of vessels or components. For example, natural gas processing plants rely on safety flares in emergency situations in which piping becomes over-pressured to mitigate risks of fires and explosions.
- To combust gas that may have hydrogen sulfide or other contaminants that are unsafe to human health.
- Required maintenance outages. Maintenance on equipment at any step in the gas transportation process may result in flaring (e.g. transmission pipelines must be taken out of service for inspections causing a cascading effect on production all the way back to the wellhead). For producers this might be maintenance at a gathering/processing facility. For gathering/processing companies this might be maintenance by the downstream gas/NGL pipeline operators resulting in flaring at a gas plant, perhaps shutting down the gas plant, which can then cause producers to flare.
- Instances where the gas takeaway capacity is interrupted with little notice for a variety of reasons. Examples can include, but are not limited to, unplanned upsets or malfunctions at gas gathering or processing facilities. When the flow of gas through a facility is stopped due to an unplanned upset or malfunction, the flow of gas is shut off immediately resulting in quickly increasing upstream pressures, potentially all the way back to the



wellhead. Flaring the gas released by the pressure control valves or the pressure safety valves is the safest, most expedient way to handle that situation.

- Regulatory constraints, including permitting, may impact any step in the development and production of crude oil and natural gas. The long lead time to receive Right of Ways (ROWs) necessary to construct and install electrical infrastructure and natural gas pipelines and facilities cause delays that may lead to flaring if well development and completion moves forward without supporting infrastructure in place.
- Limited infrastructure capacity to move natural gas or natural gas liquid (NGL) volumes out of NM Basins, including gas gathering capacity, gas processing capacity and/or capacity on long haul transmission pipelines for natural gas or NGL. Takeaway restrictions may not be predictable. For example, gas processing plants may experience limits on takeaway volumes when the sales valve is suddenly closed by the pipeline operator, resulting in the gas plant flaring, perhaps shutting down, which can then cause producers to flare. Or, oil and gas producers may experience capacity limitations on common gathering pipelines when higher than expected volumes of gas enter the lines by other operators, resulting in insufficient take-away capacity for the natural gas produced.
- Valuable information is needed in order to make decisions regarding future well and infrastructure requirements in step out or wildcat areas; therefore, flaring may be prevalent until the field fills in and infrastructure is built out.
- During pigging operations, additional backpressure on the system may cause flaring. Pigging is a necessary maintenance procedure to manage liquids buildup in the gathering lines.
- Flaring may also occur during hydrate remediation on gathering lines.
- Gas quality or composition can vary such that the gas is not suitable for pipeline transportation, processing plants, or for sales (e.g., H<sub>2</sub>S from the reservoir, oxygen introduced into the line via vapor recovery unit and other processes, temperature), that leads to flaring.
- Gas pressure at the well or facility is insufficient and the gas cannot be routed to a sales line. This is an issue for both the producer and the midstream operators.
- Electrical infrastructure issues
  - Lightning strikes and localized weather events that knock out power to compression facilities and require the use of flares.
  - Power availability and reliability needed to transport, treat, and process the hydrocarbon vapors and natural gas.

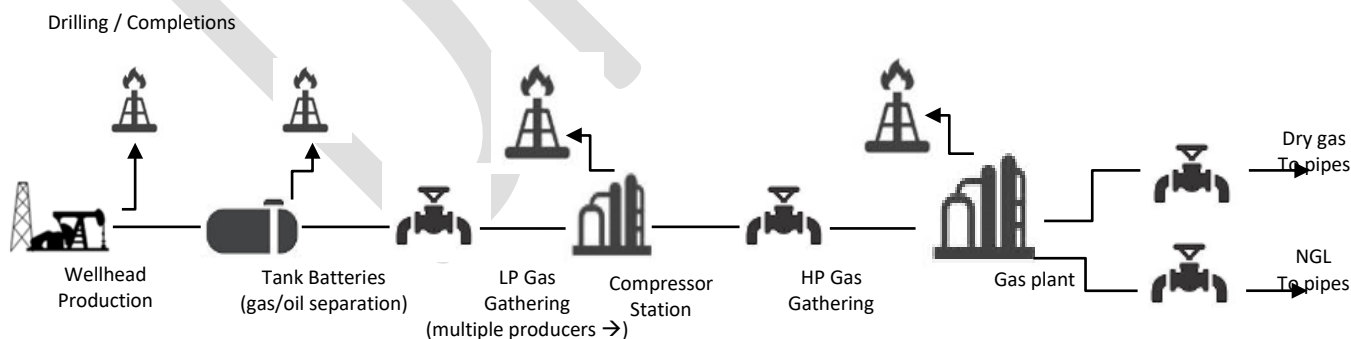

**Provide the common process configurations that use this equipment or process:**

Flaring is a common process as it is the safer alternative to venting. The figure below shows a simplified oil and gas production operation with a number of wells connected to a central tank battery by flowlines. The wellhead fluids flow to the battery where separation can occur in one or more vessels. Each vessel will be designed for a maximum allowable operating pressure (MAOP) and the system will be equipped with a variety of safety relief devices to ensure

safe operation. Safety relief devices include pressure control valves that can either stop the flow of fluids through the vessel or route excess fluid to a safety system which typically results in vapor flowing to a flare and the liquids to a tank.

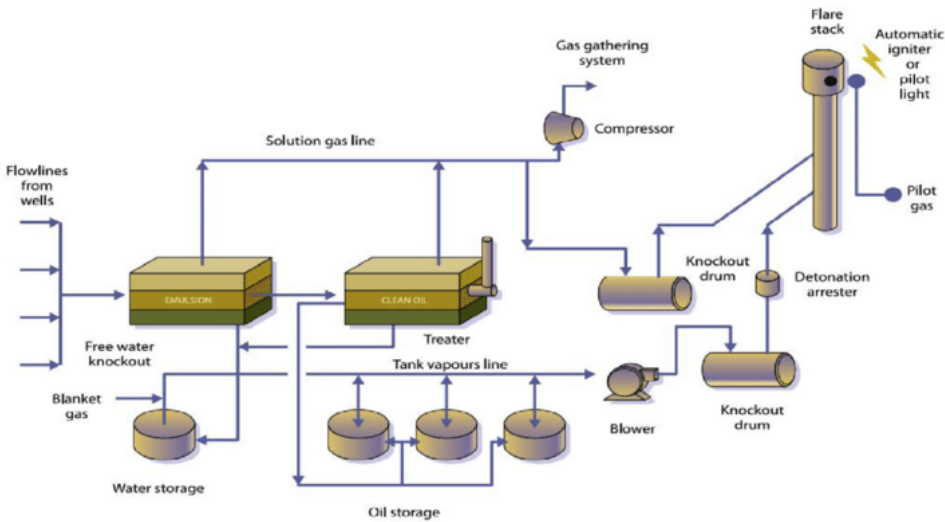

<http://dx.doi.org/10.1016/j.jestch.2016.09.012>

#### What is the distribution of the equipment or process across business segments?

Although flaring occurs in the production segment, flaring also occurs in the midstream segment. Midstream activities may include any or all of the following: compression; dehydration; treating to remove any contaminants; and processing the hydrocarbons to recover natural gas liquids (NGL's) and saleable residue natural gas. At any of those steps, if the flow of the gas through a facility is stopped due to an unplanned upset or malfunction, the flow of gas is shut off immediately resulting in quickly increasing upstream pressures, potentially all the way back to the wellhead. Flaring the gas released by the pressure control valves or the pressure safety valves is the safest, most expedient way to handle that situation.

Note: Natural gas flared in the midstream operations is downstream of the sales meter.

#### How has this equipment or process evolved over time?

##### Equipment

Over the past several years, there have been advancements in tip design in order to yield a broader range of smokeless burn, as well as advancements in the accessories associated with the flare that aid in their reliability. Auto-ignition pilots, thermocouples, pressure switches, feasible flow measurement, malfunction alarms, etc. are technical advances that have improved operation of flares, both on location and remotely.

##### Process

In November 2015, flared volumes began to be reported as a separate non-transported disposition (F code) on the NMOCD C-115 Form (Operators Monthly Report). Prior to November 2015, vented and flared volumes were reported as one non-transported disposition. NMOCD posts the vented and flared volumes on their website at this link:

<http://www.emnrd.state.nm.us/OCD/documents/C-115Non-TransportedProductDispositionFlared2016-2019.pdf>

The current Gas Capture Plan was made part of the application process through "Notice to Operators" issued on April 8, 2016, with an effective date of May 1, 2016.

- Per the Notice to Operators - The Gas Capture Plan outlines actions to be taken by the Operator to reduce well/production facility flaring and venting, for new completion (new drill, recomple to new zone, re-frac)

activity. The requirement applies to Federal, State, Fee, & Tribal Wells.

- A Gas Capture Plan's purpose is to ensure that operators are working with gatherers/processors to provide a way to get the gas to market for sales rather than flare.

## 2. INFORMATION ON EQUIPMENT OR PROCESS COSTS, SOURCES OF METHANE EMISSIONS, AND REDUCTION OR CONTROL OPTIONS

Identify the capital and operating costs for the equipment or the process. Identify how methane is emitted or could be leaked into the air. Please **prioritize** the list to identify first the largest source of methane from the process or equipment and where there is **potential** for the greatest reduction of methane emissions. Note any differences expected for differing well types, industry sector, or basin location.

### Sources of Methane:

Provide an overview of the sources of methane from this equipment or process:

The flare is elevated well above ground level, and combusted. Modern, properly operated flares have a destruction efficiency of at least 98%, thus reducing the methane and volatile organic compounds (VOCs) that would otherwise be emitted to the atmosphere had the gas been vented (the destruction efficiency of older flares generally ranges from 95%-98%). The remaining 2-5% of uncombusted gas contains methane, and is reported to EPA under the GHGRP.

A recent study of flaring in the Bakken found that while the median destruction efficiency for methane and ethane was 98%, "the efficiency distribution is skewed, exhibiting log-normal behavior." The researchers concluded: "this suggests incomplete combustion from flares contributes almost 1/5 of the total field emissions of methane and ethane measured in the Bakken shale, more than double the expected value if 98% efficiency was representative."<sup>61</sup>

Also, some flares have one or more continuously burning pilot flames, while others automatically ignite pilot flames in preparation for use. Pilots can be blown out by wind and gas is occasionally released to an unlit flare. In addition to the volume of methane that is vented when the pilot is blown out, there are emissions from incomplete combustion of the fuel gas used for the pilot.

Venting of associated gas directly releases methane (and other pollutants) into the atmosphere. Flaring releases methane from the unburned portion of the gas, and whenever the flare sputters or is unlit, such as when the pilot light goes out. Flaring also results in the loss of large quantities of natural gas through intentional combustion for means of disposal, and flaring is a significant source of the GHG CO<sub>2</sub> and many other pollutants.

Venting and flaring of associated gas largely occurs in situations where oil development outpaces infrastructure to take the gas to market. In the Permian, while almost all of the producing wells are connected to gas-gathering infrastructure, gas production growth is nonetheless overwhelming the capacity of the gathering system.<sup>62</sup> This is

<sup>61</sup> [Gvakharia et al, Methane, Black Carbon, and Ethane Emissions from Natural Gas Flares in the Bakken Shale, North Dakota, Environ. Sci. Technol.](https://pubs.acs.org/doi/10.1021/acs.est.6b05183#) 2017, 51, 9, 5317-5325 (April 12, 2017) (<https://pubs.acs.org/doi/10.1021/acs.est.6b05183#>).

<sup>62</sup> See BLM, Waste Prevention, Production Subject to Royalties, and Resource Conservation; Proposed Rule, 81 Fed Reg. 6616, 6638 (Feb. 8, 2016) (<https://www.federalregister.gov/documents/2016/02/08/2016-01865/waste-prevention-production-subject-to-royalties-and-resource-conservation>) (hereinafter BLM Proposed Rule).

also true in North Dakota, where the North Dakota Industrial Commission noted that “the majority of the gas flared . . . is from wells already connected to a gas gathering system.”<sup>63</sup>

Inadequate pipeline/gathering capacity is commonly identified as a reason for venting and flaring, and certainly, given the choice, operators would prefer to sell gas to market than flare it. But even as substantial additional gathering, processing, and pipeline capacity has come online in recent years, associated gas production has increased more rapidly and outpaced available capacity.<sup>64</sup> This mismatch between the volume of gas being produced and the available midstream or downstream capacity is occurring in part because the volume and timing of gas production in areas such as the Permian and Bakken is being driven not by the value of the gas, but the value of oil.<sup>65</sup> Because oil prices are relatively so much higher than gas prices, there is an incentive for operators in certain basins to pursue oil development and treat associated gas as a waste product. As noted by the Government Accountability Office, even though it may be profitable for operators to make investments to capture gas, it can be even more profitable for operators to invest in further oil development instead.<sup>66</sup> Absent a regulatory requirement or price incentive to capture associated gas (or significant changes in the relationship between oil and gas prices), operators are likely to continue to ramp up associated gas production faster than gas takeaway capacity is expanded in oil-producing basins, all else being equal.

The conclusions in the October 2010 GAO report mentioned above and throughout this document assumed the following gas prices. More recent data from the U.S. Energy Information Administration is included below:

	GAO	U.S. Energy Information Administration
Natural Gas	\$4.01/MMBtu	\$1.44/MMBtu. <sup>67</sup> - Southwest

This is not the only factor driving flaring, however. There is frequently a time lag between initial production or expansion of associated gas production in a given area and the development of additional gathering system capacity, as various barriers may prevent midstream companies from acquiring adequate information about operators’ production plans and midstream companies do not generally build infrastructure without some assurance of supply.

Also, even when there is sufficient capacity on a gathering system as a general matter, new hydraulically fractured wells initially produce at very high pressures and can bump older, lower-pressure wells off the system until pressures decline (or until operators boost compression at the older wells), effectively creating takeaway capacity shortfalls for a period of time.<sup>68</sup>

Finally, planned or unplanned maintenance or upsets on gathering lines, processing plants, and pipelines also temporarily reduce takeaway capacity and drive flaring.

<sup>63</sup> North Dakota Industrial Commission Order 24665 Policy/Guidance Version 102215.

<sup>64</sup> See North Dakota Department of Mineral Resources, Oil & Gas Update (Oct. 25, 2018)

(<https://www.dmr.nd.gov/oilgas/policies.asp>, link to Gas Capture Background Sheet) (“From 2014-2017 midstream built out 1 BCFD of processing capacity.”); Bismark Tribune, Industrial Commission gives oil industry more flexibility on flaring (Nov. 20, 2018) (ND Governor “commended the industry for investing nearly \$5 billion in gas capture infrastructure”).

<sup>65</sup> See Energywire, Texas’ gas glut is so bad, drillers pump it down wells (June 10, 2019) “prices have cratered, dropping as low as minus \$9 per [mmBtu] in early April” 2019).

<sup>66</sup> GAO, Federal Oil and Gas Leases: Opportunities Exist to Capture Vented and Flared Natural Gas Which Would Increase Royalty Payments and Reduce Greenhouse Gases, GAO-11-34, 24 (Oct. 2010) (<https://www.gao.gov/products/GAO-11-34>).

<sup>67</sup> <https://www.eia.gov/todayinenergy/prices.php>

<sup>68</sup> See North Dakota Department of Mineral Resources, Oil & Gas Update (Oct. 25, 2018)

(<https://www.dmr.nd.gov/oilgas/policies.asp>, link to Gas Capture Background Sheet) (“Seeing increased frequency of new high-producing wells and historically compliant wells in non-compliance due to their location on the same gathering system.”).

### New Wells:

Flares are used at both new and existing wells.

Venting and flaring occurs at new and existing wells. New wells may not be connected to gathering lines, or the capacity of those lines may not have been expanded to handle the additional gas being produced.

### Existing Wells:

Flares are used at both new and existing wells.

Venting and flaring occurs at new and existing wells. Existing lower pressure wells that are connected to gathering systems may be bumped off the system by new wells operating at much higher pressures.

### How are the emissions calculated for this equipment or process?

Flaring volumes may be included in any of these three categories; well testing venting and flaring, associated gas flaring, and/or flare stacks.

### Equations from GHGRP Subpart W:

(l) *Well testing venting and flaring.* Calculate CH<sub>4</sub> and CO<sub>2</sub> annual emissions from well testing venting as specified in paragraphs (l)(1) through (5) of this section. If emissions from well testing venting are routed to a flare, you must calculate CH<sub>4</sub>, CO<sub>2</sub>, and N<sub>2</sub>O annual emissions as specified in paragraph (l)(6) of this section.

(3) Estimate venting emissions using Equation W-17A (for oil wells) or Equation W-17B (for gas wells) of this section.

$$E_{a,n} = GOR * FR * D \quad (\text{Eq. W-17A})$$

$$E_{a,n} = PR * D \quad (\text{Eq. W-17B})$$

Where:

$E_{a,n}$  = Annual volumetric natural gas emissions from well(s) testing in cubic feet under actual conditions.

GOR = Gas to oil ratio in cubic feet of gas per barrel of oil; oil here refers to hydrocarbon liquids produced of all API gravities.

FR = Average annual flow rate in barrels of oil per day for the oil well(s) being tested.

PR = Average annual production rate in actual cubic feet per day for the gas well(s) being tested.

D = Number of days during the calendar year that the well(s) is tested.

(m) *Associated gas venting and flaring.* Calculate CH<sub>4</sub> and CO<sub>2</sub> annual emissions from associated gas venting not in conjunction with well testing (refer to paragraph (l): Well testing venting and flaring of this section) as specified in paragraphs (m)(1) through (4) of this section. If emissions from associated gas venting are routed to a flare, you must calculate CH<sub>4</sub>, CO<sub>2</sub>, and N<sub>2</sub>O annual emissions as specified in paragraph (m)(5) of this section.

(3) Estimate venting emissions using Equation W-18 of this section.

$$E_{s,n} = \sum_{q=1}^Q \sum_{p=1}^P [(GOR_{p,q} * V_{p,q}) - SG_{p,q}] \quad (\text{Eq. W-18})$$

Where:

$E_{s,n}$  = Annual volumetric natural gas emissions, at the facility level, from associated gas venting at standard conditions, in cubic feet.

GOR<sub>p,q</sub> = Gas to oil ratio, for well p in sub-basin q, in standard cubic feet of gas per barrel of oil; oil here refers to hydrocarbon liquids produced of all API gravities.

$V_{p,q}$  = Volume of oil produced, for well p in sub-basin q, in barrels in the calendar year during time periods in which associated gas was vented or flared.

$SG_{p,q}$  = Volume of associated gas sent to sales, for well p in sub-basin q, in standard cubic feet of gas in the calendar year during time periods in which associated gas was vented or flared.

x = Total number of wells in sub-basin that vent or flare associated gas.

y = Total number of sub-basins in a basin that contain wells that vent or flare associated gas.

(n) *Flare stack emissions.* Calculate CO<sub>2</sub>, CH<sub>4</sub>, and N<sub>2</sub>O emissions from a flare stack as specified in paragraphs (n)(1) through (9) of this section.

(5) Calculate GHG volumetric emissions from flaring at standard conditions using Equations W-19 and W-20 of this section.

$$E_{s,CH_4} = V_s * X_{CH_4} * [(1-\eta) * Z_U + Z_L] \quad (\text{Eq. W-19})$$

$$E_{s,CO_2} = V_s * X_{CO_2} + \sum_{j=1}^5 (\eta * V_s * Y_j * R_j * Z_L) \quad (\text{Eq. W-20})$$

Where:

$E_{s,CH_4}$  = Annual CH<sub>4</sub> emissions from flare stack in cubic feet, at standard conditions.

$E_{s,CO_2}$  = Annual CO<sub>2</sub> emissions from flare stack in cubic feet, at standard conditions.

$V_s$  = Volume of gas sent to flare in standard cubic feet, during the year as determined in paragraph (n)(1) of this section.

$\eta$  = Flare combustion efficiency, expressed as fraction of gas combusted by a burning flare (default is 0.98).

$X_{CH_4}$  = Mole fraction of CH<sub>4</sub> in the feed gas to the flare as determined in paragraph (n)(2) of this section.

$X_{CO_2}$  = Mole fraction of CO<sub>2</sub> in the feed gas to the flare as determined in paragraph (n)(2) of this section.

$Z_U$  = Fraction of the feed gas sent to an un-lit flare determined by engineering estimate and process knowledge based on best available data and operating records.

$Z_L$  = Fraction of the feed gas sent to a burning flare (equal to 1 -  $Z_U$ ).

$Y_j$  = Mole fraction of hydrocarbon constituents j (such as methane, ethane, propane, butane, and pentanes-plus) in the feed gas to the flare as determined in paragraph (n)(1) of this section.

$R_j$  = Number of carbon atoms in the hydrocarbon constituent j in the feed gas to the flare: 1 for methane, 2 for ethane, 3 for propane, 4 for butane, and 5 for pentanes-plus).

Metering of gas sent to flares. In some cases, vented or flared amounts are calculated using gas/oil ratios (GORs) that are measured periodically, with gas then calculated from measured oil production. In cases where a portion of gas from a system is sold, this portion will be metered, and operators may calculate vented or flared volumes by subtracting the captured portion from the total volume. These approaches are generally less accurate than direct metering of flared or vented streams because of issues such as temporal variation in GOR, the accuracy of emissions factors for gas diverted to use for engines and such, and other problems.

In the final 2016 BLM Methane and Waste Prevention Rule, BLM allowed for “either metering or a GOR-based calculation of flare volumes in circumstances where a GOR-based approach would allow the BLM to independently verify the volume, rate, and heating value of the flared gas.”<sup>69</sup>

<sup>69</sup> BLM, Waste Prevention, Production Subject to Royalties, and Resource Conservation; Final Rule, 81 Fed Reg. 83008, 83053 (Nov. 18, 2016) (<https://www.federalregister.gov/documents/2016/11/18/2016-27637/waste-prevention-production-subject-to-royalties-and-resource-conservation>).

During the 2016 BLM Waste Prevention, Production Subject to Royalties, and Resource Conservation rulemaking, BLM acknowledged that due to the performance limitations of many commonly used meters, a properly designed GOR based approach to estimating flare volumes could also produce adequately accurate results.<sup>70</sup> A GOR-based method for calculating volumes of flared gas uses known GOR and measured volumes of oil production and sold gas. The GOR itself is determined based on a test that directly measures in a controlled manner all of the oil and gas produced by the well over a given period of time. Calculating the volumes of flared gas based on GOR can be quite accurate, if the GOR value used is accurate and the well conditions are relatively stable. This is consistent with BLM's long standing (January 1, 1980) policy.<sup>71</sup>

BLM continued: "Since the GOR will vary as well conditions change, the accuracy of the GOR value for a well can be enhanced by more frequent GOR testing, either on a set frequency and/or in response to changes in the well's production. The BLM expects that to meet the standards of § 3179.9, GOR tests would need to be performed at least monthly for most wells."<sup>72</sup>

Both the state of North Dakota also considers calculation methods to be an acceptable method for compliance with NDIC Order #24665 as outlined in implementation Flaring Questions.<sup>73</sup>

Below is an example of the subtraction method:

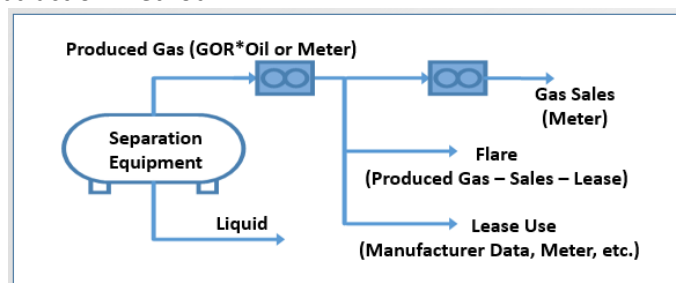

**What data is available to quantify emissions/waste for this equipment or process?**

The US EPA publishes most of the emission information and activity data that it receives as part of the US GHG Reporting Program annually ([https://ghgdata.epa.gov/ghgp/main.do?site\\_preference=normal#](https://ghgdata.epa.gov/ghgp/main.do?site_preference=normal#)). By March 31<sup>st</sup> of each year, operators upload their emission information to the EPA website for the previous year (i.e. 2018 emission information was reported in March 2019), EPA undertakes a quality assurance process, and uploads the information in October to a publicly accessible website. Care should be taken in estimating emissions from this inventory for New Mexico since both the Permian and San Juan Basins span multiple states and it is challenging to separate emissions between states for all source categories.

Here, we present an analysis of methane emissions from the oil and gas production and gathering & boosting (G&B) segments as reported to the EPA's Greenhouse Gas Reporting Program (GHGRP). GHGRP reporting began in 2011 for the production segment and in 2016 for the G&B segment. Operators with less than 25,000 MT CO<sub>2</sub>e emissions are exempt from reporting emissions to the GHGRP.

<sup>70</sup> BLM, Waste Prevention, Production Subject to Royalties, and Resource Conservation; Final Rule, 81 Fed Reg. 83053 (Nov. 18, 2016) (<https://www.federalregister.gov/documents/2016/11/18/2016-27637/waste-prevention-production-subject-to-royalties-and-resource-conservation>).

<sup>71</sup> Notice to Lessees and Operators of Onshore Federal and Indian Oil and Gas Leases, Royalty or Compensation for Oil and Gas Lost

<sup>72</sup> BLM, Waste Prevention, Production Subject to Royalties, and Resource Conservation; Final Rule, 81 Fed Reg. at 83053 (Nov. 18, 2016) (<https://www.federalregister.gov/documents/2016/11/18/2016-27637/waste-prevention-production-subject-to-royalties-and-resource-conservation>).

<sup>73</sup> Hicks, Bruce E. "NDPC Flaring Questions ICO#24665." Letter to Mr. Ron Ness. 4 July 2014.

However, it is important to note that in this analysis we have scaled emissions to account for exempt operators by basin.

In 2011, 50% of wells in the Permian basin were included in GHGRP reporting, and by 2017 coverage increased to 72%. In the San Juan Basin, over 85% of wells have been included in GHGRP reporting since 2011. For the production segment, we have scaled all emissions in each year up to the total well count reported by the New Mexico Oil Conservation Division (NMOCD) (EIA for national). For the G&B segment, no information to enable scaling-up GHGRP reported emissions is available and raw GHGRP reported emission quantities are shown.

In 2017, scaled-up New Mexico statewide GHGRP reported methane emissions totaled 205,470 metric tonnes (MT's). Of these, associated gas flaring accounted for approximately 3,536 metric tons. This amounts to 1.7% of the total New Mexico statewide methane emissions.

In 2017, scaled-up New Mexico Permian GHGRP reported methane emissions totaled 48,805 metric tonnes (MT's). Of these, associated gas flaring accounted for approximately 3,536 metric tons. This amounts to 7.2% of the total New Mexico Permian methane emissions.

\*This data does not include CO2 emissions from flaring. CO2 equivalent data is of interest as well.

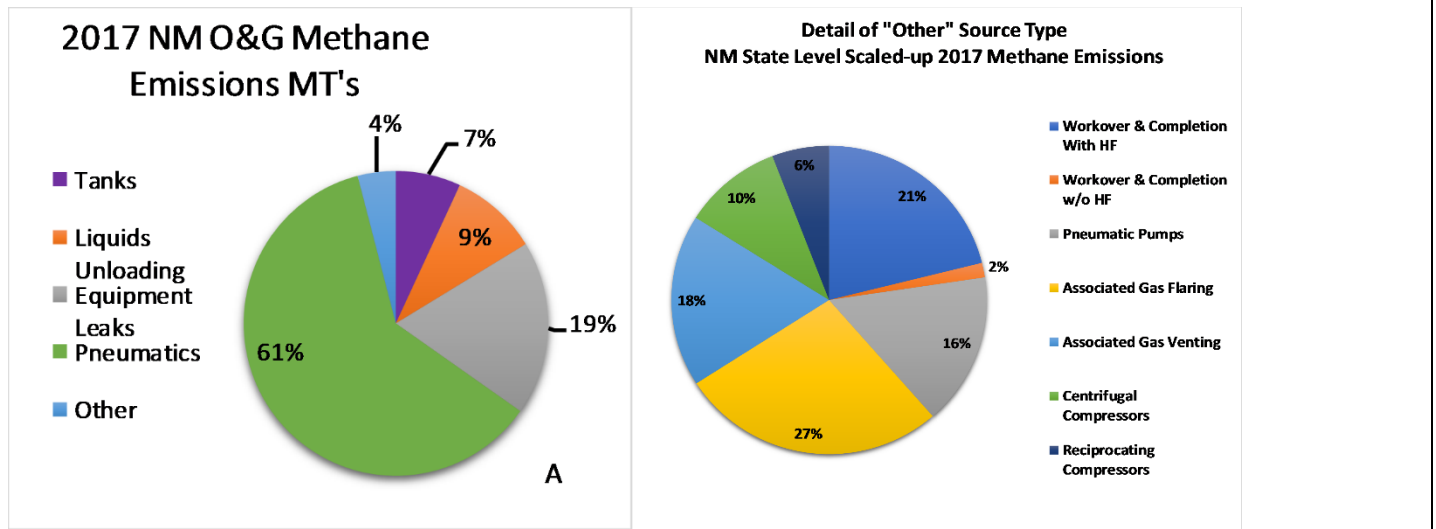



## 2017 Permian NM O&G Methane Emissions MT's

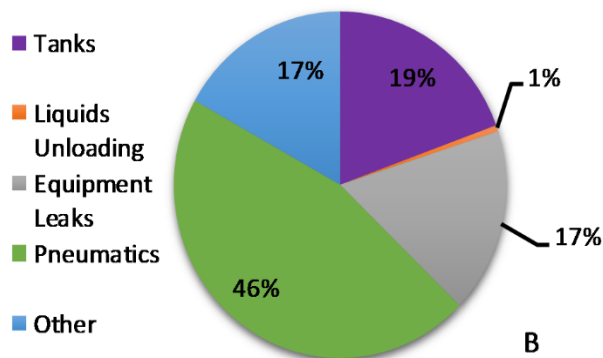

## Detail of "Other" Source Type Permian Basin NM Scaled-up 2017 Methane Emissions

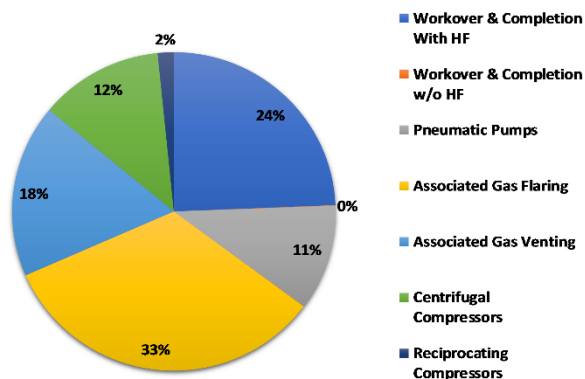

When both methane and carbon dioxide are considered, flaring contributes a larger portion of Oil and Gas greenhouse gas. For example, considering GHGRP data for 2018 for Permian wellpads, 29% of reported greenhouse gas emissions is from associated gas venting and flaring (considering the sum of CO<sub>2</sub>-equivalent emissions, using a GWP of 25 to convert methane emissions to CO<sub>2</sub>e):

Permian Wide-Emissions by Category, 2018	GHG, tCO <sub>2</sub> e	%
Combustion Equipment	7,449,180	32%
<b>Associated Gas Venting and Flaring</b>	<b>6,684,148</b>	<b>29%</b>
Natural Gas Pneumatic Devices	2,260,725	10%
Atmospheric Storage Tanks	2,237,552	10%
Flare Stacks [98.236(n)]	1,840,021	8.0%
Completions and Workovers with Hydraulic Fracturing	1,257,098	5.5%
Equipment Leaks Surveys and Population Counts	714,443	3.1%
Centrifugal Compressors	312,546	1.4%
Natural Gas Driven Pneumatic Pumps	112,017	0.5%
Well Venting for Liquids Unloading	41,775	0.2%
Other Equipment	82,542	0.4%
<b>SUM</b>	<b>22,992,045</b>	<b>100%</b>

Data downloaded from Envirofacts and summarized by CATF. GWP of 25 used to convert methane emissions to CO<sub>2</sub>e.

While this data is Permian-wide and therefore not specific to NM, the large contribution from associated gas venting & flaring to basin-wide greenhouse gas indicates that this source is an important GHG source.

A primary source of data on the quantities of gas vented and flared are the producers' C-115 reports, which require reporting of the volumes of produced gas disposed of through flaring and, separately, through venting. In addition, the report template provides disposition codes for "gas lift," "lost," "repressurizing," "used on property," and "other." As discussed elsewhere in this section, US EPA Greenhouse Gas Reporting Program data is another source of data on methane emissions, although it does not include data from smaller entities.

As shown in Table 1 and Figure 1 below, reported venting and flaring increased significantly since 2016 (even with a small decline in the first half of 2019). Reported venting has declined significantly since early 2016, which indicates that operators have reduced the practice of simply venting gas. However, the increase in reported flaring has more

than made up for the decreased venting; as gas production from oil wells has increased, development has outpaced infrastructure to handle the increased gas production. However, in New Mexico, capacity constraints may not be the main or only cause of flaring (see section on “Describe how the equipment or process is used”).

Table 1*	Total Reported Volume (mcf)		
	Vented	Flared	Vented + Flared
2019 Q2	724,641	8,319,266	9,043,907
2019 Q1	711,939	8,472,053	9,183,992
2018 Q4	613,390	11,499,805	12,113,195
2018 Q3	638,211	8,775,299	9,413,510
2018 Q2	880,210	7,828,529	8,708,739
2018 Q1	983,923	5,317,869	6,301,792
2017 Q4	544,849	4,418,534	4,963,383
2017 Q3	486,144	3,689,663	4,175,807
2017 Q2	669,194	3,774,982	4,444,176
2017 Q1	423,251	3,002,997	3,426,248
2016 Q4	521,433	4,886,637	5,408,070
2016 Q3	466,377	5,290,614	5,756,991
2016 Q2	1,020,546	5,702,331	6,722,877
2016 Q1	1,361,619	5,919,156	7,280,775

\*Data derived from C-115 reports.

Figure 1\*

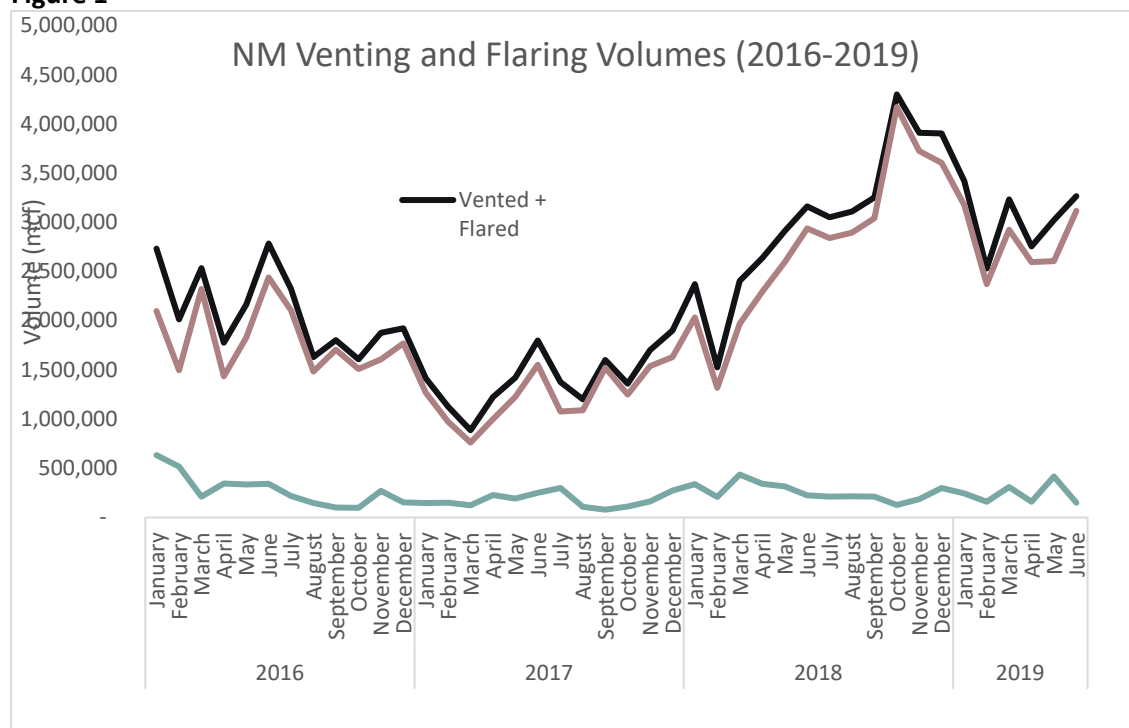

\*Data derived from C-115 reports.

As shown in Table 2, the average rate of reported venting and flaring for the past four years is over 4% (as a percent of gas production at oil wells<sup>74</sup>). While the data shows some monthly and quarterly fluctuations, the overall story is clear -- venting and flaring rates are high, and the situation is not improving.

Table 2*	% of oil well gas production		
	Vented	Flared	Vented + Flared
2019 Q2	0.3%	3.6%	3.9%
2019 Q1	0.3%	4.1%	4.5%
2018 Q4	0.3%	5.9%	6.2%
2018 Q3	0.4%	4.9%	5.2%
2018 Q2	0.5%	4.6%	5.1%
2018 Q1	0.6%	3.5%	4.2%
2017 Q4	0.4%	3.0%	3.4%
2017 Q3	0.4%	2.7%	3.0%
2017 Q2	0.5%	2.8%	3.3%
2017 Q1	0.3%	2.3%	2.6%
2016 Q4	0.4%	3.8%	4.2%
2016 Q3	0.4%	4.0%	4.3%
2016 Q2	0.8%	4.3%	5.1%
2016 Q1	1.1%	4.9%	6.0%

\*Data derived from C-115 reports.

Table 3 shows Operators vary widely in the amount of production they report as vented or flared as shown in Tables 3 and 4, with several major producers significantly increasing the amount of gas flared and vented so far in 2019.<sup>75</sup>

Top 10 Flaring Companies (January - June) *			
Anonymized Company	2018	2019	Percent Change '18-'19
1	2,207,775	2,250,606	2%
2	494,948	1,541,514	211%
3	1,302,579	1,470,907	13%
4	685,554	1,418,580	107%
5	816,429	1,401,131	72%

<sup>74</sup> Note: We calculate these rates as a percent of reported gas production at oil wells because the significant majority of the venting and flaring problem occurs at these oil wells and the discussion in this MAP report focuses on the associated gas problem. While there is a small amount of flaring occurring at gas wells, we assume that this is mainly driven by upsets and emergency situations rather than routine well operation. There is also non-trivial venting from gas wells, from activities such as liquids unloading and maintenance operations. This produces methane emissions, but is addressed in other MAP reports.

<sup>75</sup> Note: Company names have been removed and replaced with a number.

6	516,427	1,289,238	150%
7	300,128	1,064,029	255%
8	1,915,770	1,042,110	-46%
9	1,156,207	999,721	-14%
10	297,487	912,654	207%

\*Data derived from C-115 reports.

Top 10 Venting Companies (January - June)*			
Anonymized Company	2018	2019	Percent Change '18-'19
42	806,124	621,981	-23%
10	791,003	166,101	-79%
46	26,367	132,888	404%
4	6,191	121,443	1862%
47	None reported	110,758	X
2	135,473	109,856	-19%
18	None reported	73,000	X
3	1,353	21,855	1515%
48	31,317	21,788	-30%
49	None reported	18,794	X

\*Data derived from C-115 reports.

Note that as a generality, about half of the lifetime well production of associated gas occurs in the first two years of production, which has important implications for the timing of flaring reduction measures.<sup>76</sup> Gas-to-oil ratios and production decline vary greatly by well and basin.

Given the lack of consistency and standardization of reporting vented and flared volumes, it is difficult to make conclusions with the existing C-115 dataset. Industry supports a more detailed reporting program to establish consistency across the state.

#### What are the data gaps in quantifying emissions/waste for this equipment?

When reporting of flared volumes (F code) was rolled out, the only guidance given to operators was “The new code “F” is to be used to report the volume of gas that is flared on a well basis, or total volume if flared at a common battery or gathering system and reported under one point of disposition.” There was no formal standard or protocol that detailed what types of flaring to report or how to measure or estimate flared volumes.

Also, C-115s are a requirement for operators of oil and gas wells. Midstream flaring is either permitted or reported to NMED.

<sup>76</sup> Carbon Limits, Improving utilization of associated gas in US tight oil fields, 8 (April 2015)

([https://www.google.com/url?sa=t&rct=j&q=&esrc=s&source=web&cd=2&ved=2ahUKewiEw6T9j\\_vkAhVyU98KHWW5DSkQFjABegQIABAC&url=http%3A%2F%2Fwww.catf.us%2Fresources%2Fpublications%2Ffiles%2FFlaring\\_Report.pdf&usg=AOvVaw3ishdgM\\_o2N8haqov8YIBf](https://www.google.com/url?sa=t&rct=j&q=&esrc=s&source=web&cd=2&ved=2ahUKewiEw6T9j_vkAhVyU98KHWW5DSkQFjABegQIABAC&url=http%3A%2F%2Fwww.catf.us%2Fresources%2Fpublications%2Ffiles%2FFlaring_Report.pdf&usg=AOvVaw3ishdgM_o2N8haqov8YIBf)). Carbon Limits, a consultant to Clean Air Task Force, is headquartered in Oslo, Norway.

The quality of the data from C-115 reports is not robust, for several reasons. First, incomplete or inaccurate reporting results in incomplete data, which biases the emissions/waste estimates downwards. We do not know the extent of such reporting noncompliance, but in the past, it has been substantial, and there is no basis to conclude that the problem has been fully corrected.<sup>77</sup>

Second, there is a lack of guidance to operators from OCD on how to categorize the various losses of gas. Consequently, it is highly likely that there are inconsistencies across operators regarding whether all disposed gas is actually reported, and which disposition codes are used for which sources of gas. For example, it appears likely that most operators include as “vented” only the intentional direct venting of associated gas, but this excludes gas vented at temporarily unlit flares and the portion of gas that is emitted unburned from operating flares. It is also unclear whether all operators include in the flared or vented volumes gas that is flared or vented, for example, during completions or well-testing. It is also unclear, for example, whether operators are including in their C-115 reports flaring volumes that they reported on their C-129s (requests for approval to flare) or C-141s (release notification and corrective action), or whether operators are including in their C-115s only volumes that they have not otherwise reported.

Third, this data may depend to some extent on estimates of flared and vented volumes. For example, some operators may calculate flared/vented volume based on periodic GOR tests and ongoing measurement of quantities of oil production, not direct metering, as described above.

Fourth, according to OCD, it has had little capacity to audit or verify reported quantities, and operators do not generally use third party audits to spot check the accuracy of their venting and flaring reporting. As a result, there is little external incentive for operators to prioritize complete and accurate reporting of venting and flaring volumes.

Finally, it is worth noting that C-115s do not include data on venting and flaring that occurs during midstream operations. It is not clear what data is available on those volumes, although it may be possible to derive data on this from NMED permits, excess emissions reporting, and/or the GHGRP.

The likelihood that C-115 data captures only a subset of overall venting and flaring from oil and gas activities is reinforced by NOAA satellite flaring data for recent years, which indicates that that OCD flaring data is too low.<sup>78</sup>

#### NOAA Quantification of Flaring from NM

---

<sup>77</sup> For example, in a Notice to Operators in 2017, OCD “determined that not all Operators are following the requirement to report flared and vented volumes. Out of 603 well Operators active in the state, only 51 Operators are reporting volumes using the “V” and “F” code. It is very important that all Operators in New Mexico report flared and vented volumes since part of the evaluation will help determine any policy or requirements setting goals for reduction of flared gas. We urge all companies to work with their operations and production accounting groups to ensure proper production reporting.” Notice to Oil and Gas Operators, Vented & Flared Volumes Reporting Communication, March 8, 2017. Available at <http://www.emnrd.state.nm.us/OCD/documents/20173-8NoticetoOperators.pdf>

<sup>78</sup> [https://www.ngdc.noaa.gov/eog/viirs/download\\_global\\_flare.html](https://www.ngdc.noaa.gov/eog/viirs/download_global_flare.html); see also Elvidge et al Methods for Global Survey of Natural Gas Flaring from Visible Infrared Imaging Radiometer Suite Data, *Energies* **2016**, 9(1), 14; <https://doi.org/10.3390/en9010014>.

Year	Bcf gas flared
2012	14.4
2013	24.3
2014	31.3
2015	41.2
2016	30.5
2017	22.4
2018	41.5

These NOAA estimates are derived from radiance measurements in the SWIR part of the spectrum (nonvisible light, falling roughly between 1400 and 3000 nanometers) measured by the VIIRS instrument (whiskbroom scanning radiometer that collects imagery and radiometric measurements) at night. There are several steps that are required to derive flaring emission estimates from radiance measurements from VIIRS:

1. First, a determination as to which bright pixels are flares or fires – this requires a certain set of assumptions that introduce uncertainty;
2. Once a determination of whether a bright pixel is a flare, flaring duration must be assessed. VIIRS provides data for one second of a day unless a cloud is blocking the bright pixel. Based upon that one second, a determination as to whether the observed flare is persistent or intermittent must be made. The easiest assumption is persistence, but may not always be valid and could lead to overestimates of flared gas.
3. The next step requires a conversion of flare radiance to an emission rate. This conversion is performed by a logarithmic fit between measured radiance-derived Fire Radiative Power and reported flared gas volumes from the Cedigaz database. Such a calibration neglects very real variability in flare combustion efficiency as well as variability in gas composition (gas heating values). Also, the Cedigaz database includes both flaring and venting, however, this study assumed venting was negligible in the Cedigaz numbers.

In summary the emissions estimates presented here are only as good as the aforementioned assumptions used to derive them. In the table below, it is important to note that there is no uncertainty of ranges included. Without a secondary verification through correlating direct measurement at these bright pixelated locations, it is impossible to determine the accuracy of these emissions estimates. Emissions estimates such as these may be more useful in understanding year-to-year trends in flared gas volume, rather than the absolute amount of gas flared.

**Economic Description of the Process or Equipment:**

<u>What is the per unit cost of the equipment or the costs associated with the process?</u>
Equipment costs for flares vary greatly and must be determined on a case-by-case basis.
<u>What are the annualized operating costs for the equipment or costs associated with the process?</u>
Equipment costs for flares vary greatly and must be determined on a case-by-case basis.
<u>If the equipment or process is powered, what are the costs?</u>
N/A
<u>What are the maintenance and repair costs for existing or new equipment?</u>

Maintenance costs for flares vary greatly and must be determined on a case-by-case basis.

#### **Existing Reduction Strategies:**

##### How has industry reduced emissions/waste from this equipment or process historically?

Engineering advancements of flare tip designs to improve combustion efficiency. Also, Gas Capture Plans ensure operators are working with gatherers/processors to develop solutions to get the gas to market for sales rather than flare. Operators are proactively working with midstream solution providers, internal and 3<sup>rd</sup> party, to construct and commission facilities and pipelines in advance of drilling. Leases and other oil and gas agreements often require operators to drill in given time frames, although these terms may be subject modification by regulations. When possible, operators are shifting drilling and production schedules to minimize the number of stranded wells and the need to flare gas due to a lack of take away pipelines or downstream facilities.

Operators are designing multiple well pads which provide additional time to install the required pipelines and facilities and reduce the number of stranded wells. Operators will occasionally shut in production to mitigate a flaring event. However, shutting in production results in the loss of royalties paid to all interest holders, including the public if the New Mexico State Land Office or Federal Bureau of Land Management receive revenue from that particular lease and may result in formation damage which could impact total recovered hydrocarbons.

Companies also utilize several technological advancements to increase the destruction and removal efficiency of flares and identify beneficial uses in oil and gas operations.

It is important to note that the best solution to flaring is always having a sales pipeline.

With respect to temporary shut in of production, royalties should be considered deferred, not lost, as the production from the well is delayed, not ended.

##### New Wells:

##### Existing Wells:

##### How have the emission/waste reductions been measured?

Emissions from a flare rely heavily upon flow to the flare which can be estimated or measured. Estimation in this instance involves the use of known well or reservoir information such as periodic well tests or a well's gas to oil ratio to estimate a well's gas production rate. For example, if a production flow test is conducted monthly on a well, the resulting rate could provide a reliable basis to calculate the well's gas production for the entire month. Similarly, if a well has a gas to oil ratio that is uniform over time, the operator could estimate the rate of gas production based on the measured rate of oil production and the gas to oil ratio. Gas volume estimation using these protocols is suitable for reporting flared gas volumes in many cases.

There are also various technologies for measuring flow to the flare. Measurement options are primarily limited to volumes sent to the high pressure flare. In these operating circumstances there is enough volume and energy in the

process stream to measure the flowrate. However, in low pressure conditions, such as storage tank vent headers, emissions/flare volumes are typically calculated from process conditions using EPA guidance due to technical feasibility issues with measurement of these low flow, low energy flows.

High pressure flare volumes fluctuate widely: from small volumes under normal conditions to full gas stream under upset or emergency conditions, even changing repeatedly throughout the day depending on sales line capacity. Any meter for a high pressure flare must accurately accommodate this broad production range.

Conversely, to improve accuracy at low volumes, a smaller orifice size is required but such a restriction in the flare piping introduces intolerable safety concerns when flow increases. Furthermore, an orifice meter will restrict the line to the flare such that when large volumes are flared for emergency purposes, it will result in an explosion. Other meter options such as ultrasonic or thermal mass can be more costly, and depending on technology, can be very sensitive to operating and ambient conditions at low flow conditions, e.g. thermal mass meter.

North Dakota Petroleum Council Summary			
Common Meter Types	Accuracy	Limitations	Cost
Differential Pressure (Orifice)	Poor	Adds pressure drop (safety), poor for high variability, calibration challenge	Low - High
Thermal Mass	Poor	Gas composition, moisture	Medium
Ultrasonic	<10%	Low velocity, moisture	High

API Manual of Petroleum Measurement Standards (MPMS) Chapter 14, Section 10, Measurement of Flow to Flares addresses measurement of flow to flares and includes:

- application considerations,
- selection criteria and other considerations for flare meters and related
- instrumentation,
- installation considerations,
- limitations of flare measurement technologies,
- calibration,
- operation,
- uncertainty and propagation of error, and
- calculations.

Technology	Sensitivity to Entrained Mist or Liquid	Sensitivity to Fouling	Ability to Detect Fouling
Differential Pressure	Low to Moderate (varies with liquid load)	Moderate	Physical Inspection
Thermal Flow	High	High	Physical Inspection
Optical	Moderate	High	Meter Diagnostics
Ultrasonic	Low (unless sensor is immersed in liquid, then very high)	High	Meter Diagnostics
Vortex	Low (if meter is installed in horizontal line and bluff body is horizontal)	Low to High (varies with meter design)	Physical Inspection

Waste reductions are measured as the change in the measured volumes and percentages of produced gas that are vented or flared per well/lease/operator/state over time.



How have states and the federal government reduced emissions/waste from this equipment or process historically?  
In addition, please identify voluntary reductions achieved whether or not they were in response to a regulatory action/requirement.

#### **VOLUNTARY**

Some oil and gas companies have committed to voluntary initiatives to reduce flaring. Companies also utilize several technological advancements to increase the destruction and removal efficiency of flares and identify beneficial uses in oil and gas operations. (See “Existing Reduction Strategy” section above).

#### **FEDERAL - BLM**

43 CFR Subpart 3179 Waste Prevention and Resource Conservation includes requirements and determinations of waste for oil well flaring.

- §3179.4(a) & (b) outline what is considered avoidable (royalty bearing) and unavoidable (non-royalty bearing) lost production.
- §3179.6(b). The operator must flare, rather than vent, any gas that is not captured, except under certain circumstances.
- §3179.101 – 104 outlines “Authorized Flaring and Venting of Gas.” “Authorized” is described as being unavoidable royalty-free gas.
  - §3179.101 Initial production testing
  - §3179.102 Subsequent well tests
  - §3179.103 Emergencies
  - §3179.104 Downhole well maintenance and liquids unloading
- §3179.201(a) Oil-well gas
  - Except as provided in §§ 3179.101, 3179.102, 3179.103, and 3179.104, vented or flared oil-well gas is royalty free if it is vented or flared pursuant to applicable rules, regulations, or orders of the appropriate State regulatory agency or tribe. Applicable State or tribal rules, regulations, or orders are appropriate if they place limitations on the venting and flaring of oil-well gas, including through general or qualified prohibitions, volume or time limitations, capture percentage requirements, or trading mechanisms.

#### BLM

Prior to 2016, BLM addressed venting and flaring of associated gas under NTL-4A, which prohibited operators from venting or flaring oil well gas unless approved in advance by BLM. Approval could be granted if justified by “(1) an evaluation report supported by engineering, geologic, and economic data which demonstrates to the satisfaction of [BLM] that the expenditures necessary to market or beneficially use such gas are not economically justified and that conservation of the gas, if required, would lead to the premature abandonment of recoverable oil reserves and ultimately to a greater loss of equivalent energy than would be recovered if the venting or flaring were permitted to continue or (2) an action plan that will eliminate venting or flaring of the gas within 1 year from the date of application.”<sup>79</sup> NTL-4A further provided that “[w]hen evaluating the feasibility of requiring conservation of the gas, the total leasehold production, including both oil and gas, as well as the economics of a field wide plan shall be considered by [BLM] in determining whether the lease can be operated successfully if it is required that the gas be conserved.”<sup>80</sup> Thus, the text of NTL-4A required an assessment of whether the operator could still successfully operate the entire leasehold, including the profits from both oil and gas production, while conserving gas (not merely a showing that it would cost the operator more to conserve the gas than to capture it, as has at times been asserted).

---

<sup>79</sup> NTL-4A, 3-4.

<sup>80</sup> NTL-4A, 4.

In practice, however, BLM appears to have accepted more minimal showings as a basis for routinely approving requests to allow venting and flaring.

Concerned about growing volumes of waste of gas, particularly from venting and flaring of associated gas, and with reforms urged by oversight entities such as the Government Accountability Office (GAO) and the IG Inspector General, BLM undertook a multi-year rulemaking to replace NTL-4A with far more effective requirements to control the waste of natural gas.<sup>81</sup> The final Methane and Waste Prevention Rule, issued in November 2016, established new controls on venting and flaring of associated gas.<sup>82</sup> With respect to venting and flaring, the rule: (1) required operators to file Waste Minimization Plans as a condition of receiving approval of an Application for Permit to Drill (43 CFR 3162.3-1); (2) prohibited flaring or venting of gas well gas, except where the gas was “unavoidably lost” as defined in the regulations (43 CFR 3179.6(a)); (3) required operators to flare rather than vent any gas that is not captured, except under specific circumstances detailed in the regulations (43 CFR 3179.6(b)); and (4) established gas capture requirements to ensure that operators must, over time, capture rather than flare an increasing volume of their gas (43 CFR 3179.7).

Specifically, the percentage of gas that operators were required to capture (which includes beneficial on-lease use) ratcheted up from 85% beginning in 2018, to 90% in 2020, to 95% in 2023, to 98% in 2026. These percentages applied to the “adjusted total volume of gas produced” by an operator each month. This “adjusted total volume of gas produced” was the operator’s total volume of gas captured, plus the total volume of gas flared from high pressure flares from development oil wells, minus an allowable amount of flaring per well, all calculated on a monthly basis. The allowable amount of flaring per well ratcheted down over time (as the percentage capture requirement ratcheted up) from 3,600 Mcf/well beginning in 2019, to 1,800 Mcf/well in 2020, to 1,500 Mcf/well in 2021, to 1,200 Mcf/well in 2022, to 900 Mcf/well in 2024, to 750 Mcf/well from 2025 on.<sup>83</sup> Operators had the option of complying on a lease-by-lease, county-by-county, or state-wide basis, which gave operators the maximum flexibility to average capture volumes across all of an operator’s wells within each state.

Note that because the BLM rule applied to then-current conditions across multiple states, it was calibrated to assure feasibility even in the most extreme venting and flaring circumstances, which were then (and still are) occurring in North Dakota. Absent those circumstances, BLM’s flaring data analysis underlying the rule would likely have supported lower limits. The percentage and volume limitations considered appropriate for a national rule promulgated in 2016 would not necessarily be directly applicable for a single state-specific rule promulgated in 2020. The BLM 2016 percent gas capture rule dataset was limited to federal minerals and relied upon the broad application of uneconomic temporary capture technologies and unrealistic market assumptions. These percent capture provisions were stayed by a federal district court on April 4, 2018, therefore, were never observed for effectiveness in any real-world field-wide practice.

---

<sup>81</sup> See, e.g., GAO, Federal Oil and Gas Leases: Opportunities Exist to Capture Vented and Flared Natural Gas Which Would Increase Royalty Payments and Reduce Greenhouse Gases, GAO-11-34, 24 (Oct. 2010) (<https://www.gao.gov/products/GAO-11-34>). CITE GAO, IG reports.

<sup>82</sup> BLM, Waste Prevention, Production Subject to Royalties, and Resource Conservation; Final Rule, 81 Fed Reg. 83008 (Nov. 18, 2016) (<https://www.federalregister.gov/documents/2016/11/18/2016-27637/waste-prevention-production-subject-to-royalties-and-resource-conservation>).

<sup>83</sup> BLM selected these values based on its analysis of flaring rates of gas from oil wells in 15,530 records from data of the Office of Natural Resources Revenues, representing monthly flared volumes on a lease or unit basis from over 2,000 unique leases or units over a yearlong period from October 1, 2013 to September 30, 2014, as well as BLM data on the number of wells per lease. BLM Proposed Rule at 6639.

The rule also established measurement and reporting requirements for all volumes of gas vented or flared (43 CFR 3179.9).

In 2018, BLM largely rescinded the 2016 rule, although the constraints on venting remain in place (43 CFR 3179.6).<sup>84</sup> The 2018 rule provides that venting or flaring oil-well gas does not require approval from BLM and is royalty free, “if it is vented or flared pursuant to applicable rules, regulations, or orders of the appropriate State regulatory agency or tribe.” (43 CFR 3179.201)

## **NEW MEXICO**

Current NMOCD regulation:

The current regulatory framework in New Mexico requires approval from the NMOCD if an operator needs to flare beyond the first 60 days after completion (NMAC 19.15.18.12.A & B).

- 19.15.18.12.A. NMAC An operator shall not flare or vent casinghead gas produced from a well after 60 days following the well’s completion.
- 19.15.18.12.B. NMAC An operator seeking an exception to Subsection A of 19.15.18.12 NMAC shall file an application for an exception on form C-129 with the appropriate division district office. The district supervisor may grant an exception when the flaring or venting casinghead gas appears reasonably necessary to protect correlative rights, prevent waste or prevent undue hardships on the applicant. The district supervisor shall either grant the exception within 10 days after the application’s receipt or refer it to the director who shall advertise the matter for public hearing if the applicant desires a hearing.

In addition, current NMOCD regulation authorizes flaring and requires volumes to be reported on C-115 (NMAC 19.15.18.12.F.)

- 19.15.18.12.F. NMAC Pending connection of a well to a gas-gathering facility, or when a well has been excepted from the provisions of Subsection A of 19.15.18.12 NMAC, the operator shall burn all gas produced and not used, and report the estimated volume on form C-115.

From a midstream perspective, NMOCD requires notification of prolonged mechanical difficulties or plant shut downs (NMAC 19.15.18.12.E.)

- 19.15.18.12.E. NMAC In the event of a more prolonged mechanical difficulty or in the event of plant shut-downs or curtailment because of scheduled or non-scheduled maintenance or testing operations or other reasons, or in the event a plant is unable to accept, process and market all of the casinghead gas produced by wells connected to its system, the plant operator shall notify the division as soon as possible of the full details of the shut-down or curtailment, following which the division shall take such action as is necessary to reduce the total flow of gas to the plant.

Current NMAC 19.15.7.24. Operators Monthly Report (Form C-115) requires complete information and data indicated, which includes Non-transported volumes (disposition codes F-flared and V-vented), on the forms to be submitted. Also, NMOCD has authority to cancel the operator’s authority to transport from or inject into all wells it operates for failure to file an acceptable and complete form C-115 (19.15.7.24.C. NMAC).

- 19.15.7.24.A. NMAC An operator shall file a form C-115 for each non-plugged well completion for which the division has approved a form C-104 and for each secondary or other enhanced recovery project or pressure maintenance project injection well or other injection well within the state, setting forth complete information and data indicated on the forms in the order, format and style the director prescribes. The operator shall

---

<sup>84</sup> BLM, Waste Prevention, Production Subject to Royalties, and Resource Conservation; Rescission or Revision of Certain Requirements; Final Rule, 83 Fed Reg. 83008 (Sept. 28, 2018) (<https://www.federalregister.gov/documents/2018/09/28/2018-20689/waste-prevention-production-subject-to-royalties-and-resource-conservation-rescission-or-revision-of>).

estimate oil production from wells producing into common storage as accurately as possible on the basis of periodic tests.

- 19.15.7.24.C. NMAC If an operator fails to file a form C-115 that the division accepts, the division shall, within 30 days of the appropriate filing date, notify the operator by electronic mail or letter of its intent to cancel the operator's authorization to transport or inject if the operator does not file an acceptable and complete form C-115. The notice shall inform the operator of the right to request a hearing pursuant to 19.15.4.8 NMAC. If the operator does not either file an acceptable and complete form C-115 or request a hearing on the proposed cancellation within 60 days of the original due date of the form C-115, the division may cancel the operator's authority to transport from or inject into all wells it operates.

The current Gas Capture Plan was made part of the application process through "Notice to Operators" issued on April 8, 2016, with an effective date of May 1, 2016.

- Per the Notice to Operators - The Gas Capture Plan outlines actions to be taken by the Operator to reduce well/production facility flaring and venting for new completion (new drill, recomple to new zone, re-frac) activity. The requirement applies to Federal, State, Fee, & Tribal Wells.
- A Gas Capture Plan purpose is to ensure operators are working with gatherers/processors to provide a way to get the gas to market for sales rather than flare.

Current NMED regulations:

Emissions from venting and flaring is authorized by NMED:

- 20.2.72.200. Permits must be obtained from the department by: (1) Any person constructing a stationary source which has the potential emission rate greater than 10 pounds per hour or 25 tons per year of any regulated air contaminant for which there is a National or New Mexico Ambient Air Quality Standard.
- Combustion emissions resulting from routine flaring is authorized through one or more air permits.
  - The GCP-Temporary Control Major and Minor permits authorize the flaring or combustion of stranded gas for a period not to exceed 12 consecutive months.
  - The GCP-Oil & Gas may also be used to authorize routine process flaring.
  - The GCP-6 permit authorizes flares and other methods to reduce emissions from oil and gas storage tanks.
  - Per 20.2.70, an NSR/Title V Operating Permit is required for stationary sources that have actual or potential emissions equal to or greater than 100 tons per year of any regulated air pollutant.
- The flaring emissions to be authorized will be dependent on specific facility configuration, operating conditions, gas composition, and volume of gas sent to the flare.
- Per 20.2.7, flaring in excess of an authorization is required to be reported to NMED as an excess emission event.

#### New Mexico

The applicable NM law defines "surface waste" to include "the unnecessary or excessive surface loss of destruction without beneficial use . . . of natural gas of any type or in any form . . . including the loss or destruction, without beneficial use, resulting from evaporation, seepage, leakage or fire, especially such loss or destruction incident or resulting from the manner of spacing, equipping, operating or producing, well or wells, or incident to or resulting from . . . the production of . . . natural gas in excess of the reasonable market demand."<sup>85</sup> The NM regulations clearly prohibit "the production or handling" of gas "in a manner, under conditions or in an amount as to constitute or result

---

<sup>85</sup> New Mexico Statutes Annotated, section 70-2-3 B.

in waste.”<sup>86</sup> The regulations further provide that operators “shall conduct their operations in or related to the drilling, equipping, operating, producing . . . of oil, gas . . . wells or other facilities . . . in a manner that prevents waste of oil and gas . . . ” and bar operators from “wastefully utiliz[ing] oil or gas or allowing either to leak or escape” from reservoirs, wells and other operating equipment.<sup>87</sup>

In general, the New Mexico Oil and Gas Act requires the New Mexico Oil Conservation Commission (NMOCC) and New Mexico Oil Conservation Division (NMOCD) to prohibit production and oil and gas handling practices which constitute or result in waste. NMSA 1978, § 70-2-2. The concept of “waste” has been statutorily defined by the New Mexico Legislature to include both underground waste and surface waste. NMSA 1978, § 70-2-3. Underground waste can consist of any practice that reduces or tends to reduce the total quantity of crude oil or natural gas ultimately recovered from a reservoir, e.g. shutting in a well; whereas surface waste consists of unnecessary or excessive surface loss or destruction of oil or gas, without beneficial use. Thus, NMOCC and NMOCD are required by statute to encourage the optimum recovery of oil and gas resources. The federal government and other oil and gas producing states similarly prohibit the creation of waste. *See e.g.*, 30 U.S.C. § 187; 30 U.S.C. § 225; WYO. STAT. ANN. § 30-5-101.

For the purpose of limiting venting and flaring, “waste” has historically been defined by the federal government and other oil and gas producing jurisdictions as a “preventable loss of [oil or gas] the value of which exceeds the cost of avoidance.” Stephen L. McDonald, *Petroleum Conservation in the United States, and Economic Analysis*, Johns Hopkins Press, 1971 (Reprinted in 2011 by Resources for the Future) (“Petroleum Conservation Economics”), at 129. NMOCD regulations have likewise allowed flaring in situations where “the flaring or venting casinghead gas appears reasonably necessary to protect correlative rights, prevent waste or prevent undue hardships” on the operator. 19.15.18.12.B NMAC. Indeed, flare may provide environmental benefits in certain situations. The New Mexico Environment Department (NMED) has approved flaring in a variety of situations, and the federal government specifically requires flaring in certain situations. *See* NMED, Air Quality Bureau General Construction Permits; 43 C.F.R. § 3179.6(b).

The current NM regulations on casinghead gas also generally bar flaring or venting of casinghead gas, beginning 60 days after the well’s completion.<sup>88</sup> In addition to the exemption for the first 60 days of production, these provisions allow for an exception wherever flaring or venting “appears reasonably necessary” to “prevent undue hardships on the applicant.”<sup>89</sup> If the application for an exception is not granted in 10 days, it must be referred to the director, who must hold a hearing the matter if the applicant wishes.<sup>90</sup> In effect, this means that to maintain the general prohibition on flaring, the director would have to hold a hearing on and make the decision to reject each individual flaring application. This is simply untenable from an agency workload perspective, and it is no surprise that OCD routinely grants most or almost all flaring exception applications.

Thus, current OCD regulations have not been effective in limiting venting and flaring of associated gas.

## WYOMING

Wyoming Oil and Gas Conservation Commission rules ([055-3 WYO. CODE R. § 39](#)) impose restrictions on venting and flaring. The Wyoming rules authorize venting and flaring under the following circumstances: (1) emergencies, (2) well purging and evaluation tests, and (3) production tests (for 15 days, unless a longer period is authorized). In addition, the rules authorize the flaring of up to 60 Mcf of gas per day from individual oil wells. (Associated gas may be vented where the rate does not exceed 20 Mcf per day.) An operator may also apply for authorization to flare in other circumstances. An operator’s application for authorization to flare must include, among other information, a gas

---

<sup>86</sup> NMAC 19.15.2.8.

<sup>87</sup> *Id.*

<sup>88</sup> NMAC 19.15.18.12.

<sup>89</sup> *Id.*

<sup>90</sup> *Id.*

capture plan identifying gas gathering and transportation facilities in the area, the name of gas gatherers providing “gas take-away capacity,” and information on the gas gathering line to which the operator proposes to connect.

## **COLORADO**

Colorado Oil and Gas Conservation Commission regulations restrict the venting or flaring of natural gas. [2 COLO. CODE REGS. § 404-1-912](#). Under those regulations, “[t]he unnecessary or excessive venting or flaring of natural gas from a well is prohibited.” An operator must obtain prior approval from the Commission for venting or flaring, “[e]xcept for gas flared or vented during an upset condition, well maintenance, well stimulation flowback, purging operations, or a productivity test.” Gas flared, vented, or used on the lease must be estimated using a gas-to-oil ratio test or other approved method and reported on a monthly basis.

## **NORTH DAKOTA**

North Dakota’s statutory restrictions on the flaring of associated gas are found in North Dakota Century Code section [38-08-06.4](#).

- Under this statute, operators are allowed to flare associated gas for a period of one year from the date of first production of the well. After that period, the well must be: (1) capped, (2) connected to a gathering line, (3) equipped with an electrical generator that consumes 75% the gas, (4) equipped with an approved process that reduces the volume or intensity of the flare by 60%, or (5) equipped with a system that captures 75% of the gas for consumption by means of use as fuel, transport to processing, production of chemicals/fertilizer, or separating and collecting over 50% of the propane and heavier hydrocarbons. Operators who violate section 38-08-06.4 must pay royalties and taxes on the flared gas.
- An operator may obtain an exemption from section 38-08-06.4 from the North Dakota Industrial Commission by showing “that connection of the well to a natural gas gathering line is economically infeasible at the time of the application or in the foreseeable future or that a market for the gas is not available and that equipping the well with an electrical generator to produce electricity from gas or employing a collection system . . . is economically infeasible.”

The North Dakota Industrial Commission has established a special policy for wells in the Bakken, Bakken/Three Forks, and Three Forks Pools. See [NDIC Order 24665](#).

- In those fields, wells are allowed to produce at the maximum efficient rate for the first 90 days, after which the wells may continue to produce at the maximum efficient rate only if the well or operator meets or exceeds Commission approved gas capture goals. (This restriction does not apply to (1) the first horizontal well completed in a non-overlapping spacing unit, or (2) wells that have received an exemption from North Dakota Century Code section 38-08-06.4.) The NDIC has established the following gas capture goals:

74% October 1, 2014 through December 31, 2014  
77% January 1, 2015 through March 31, 2016  
80% April 1, 2016 through October 31, 2016  
85% November 1, 2016 through October 31, 2018  
88% November 1, 2018 through October 31, 2020  
91 % beginning November 1, 2020

North Dakota Industrial Commission Order 24665 [Policy/Guidance](#) Version 102215 (Oct. 22, 2015).

- North Dakota requires that Applications for a Permit to Drill (APD) be accompanied by a Gas Capture Plan containing the following: (1) affidavit indicating coordination with a mid-stream company, (2) a detailed gas gathering pipeline system location map, (3) information on the gathering line to which the operator proposes to connect, (4) the anticipated date of first production and the anticipated production rates, (5) the amount of gas the applicant is flaring, and (6) explanation of alternatives to flaring.

## North Dakota

In response to very high flaring rates of associated gas, the North Dakota Industrial Commission adopted in July 2014, Order 24665 to limit flaring.<sup>91</sup> The Commission supplemented this order with guidance and several letters to operators, which the Commission has modified over time. As supplemented, the order provides that operators in the Bakken/Three Forks areas must capture 74% of gas by Oct. 1, 2014; 77% by Jan. 1, 2015; 80% by April 1, 2016; 85% by Nov. 1, 2016; 88% by Nov. 1, 2018, and 91% by Oct. 1, 2020, with potential for 95% capture as attainable.<sup>92</sup>

The guidance requires:

- gas capture plans for increased density and spacing cased and a sworn affidavit that the operator has provided gas production forecast data to midstream gas gathering companies;
- gas capture plans “for all applications for a permit to drill filed by an operator who has failed to meet gas capture goals in any of the most recent three months;”
- meeting the gas capture goals on a monthly basis, statewide, by county, by field, or by well for each operator.<sup>93</sup>

In calculating compliance with the capture goals, operators were initially allowed to remove: the initial 14 days of flowback; flaring due to a force majeure event on the gas gathering system; and the flared remainder after application of a “value-added” process (such as stripping out the NGLs) that reduces flare volume or intensity by over 60%.<sup>94</sup>

If an operator fails to meet the gas capture goals, the guidance states that “well(s) will be restricted to 200 barrels of oil per day if at least 60%” of the gas is captured, or 100 barrels per day otherwise.<sup>95</sup> In practice, however, production restrictions have been applied to very small quantities of production for limited time frames. In part this is because the guidance allows operators to exempt substantial quantities of flared gas from their compliance calculations, and in part this is because even when operators are not in compliance, the Commission appears to have applied production restrictions only rarely.<sup>96</sup>

Initially, it appeared that the new requirements were having some effect – the percentage of produced gas that was flared fell from roughly a third in 2013 to a low of slightly less than 10% in one month in 2015. Since then, however, the percentage of produced gas flared has risen again, rather than continuing to improve, and it has been falling further short of the percentage capture goals.<sup>97</sup> Analysis conducted by Clean Air Task Force on production and flaring in 2017 showed that a number of operators producing oil and gas from the Bakken/Three Forks formations consistently failed to meet the Commission’s Gas Capture standard (even considering the provisions allowing operators to exclude certain flared gas volumes when calculating their gas capture percentage), yet they did not suffer any sanction from NDIC.<sup>98</sup> Note that no information is publicly available on why NDIC chose not to sanction operators that fail to meet the Gas Capture standard or on related matters such as declared force majeure events.

<sup>91</sup> Industrial Commission of the State of North Dakota, Order No. 24665 (July 1, 2014);

<sup>92</sup> Industrial Commission of the State of North Dakota, Order No. 24665 (July 1, 2014); North Dakota Industrial Commission Order 24665 Policy/Guidance Version 102215 (Sept. 2015); see also, Reuters, North Dakota postpones deadline for natural gas flaring rules (Sept. 24, 2015) (<https://www.reuters.com/article/us-north-dakota-flaring-idUSKCNORO2KX20150924>).

<sup>93</sup> North Dakota Industrial Commission Order 24665 Policy/Guidance Version 112018 (Nov. 20, 2018).

<sup>94</sup> North Dakota Industrial Commission Order 24665 Policy/Guidance Version 102215 (Sept. 2015).

<sup>95</sup> North Dakota Industrial Commission Order 24665 Policy/Guidance Version 112018 (Nov. 20, 2018).

<sup>96</sup> See Bismarck Tribune, Oil industry missed October’s flaring target, revised numbers show (Jan. 19, 2018) (reporting that in October 2017, 11 companies exceeded the 15% flaring limit, but none were ordered to limit oil production because they met one of the conditions in the policy).

<sup>97</sup> See North Dakota Department of Mineral Resources, Oil & Gas Update (Oct. 25, 2018) (<https://www.dmr.nd.gov/oilgas/policies.asp>, link to Gas Capture Background Sheet).

<sup>98</sup> See Citizen Groups Commenter’s 2018 Comments on BLM’s “Waste Prevention, Production Subject to Royalties, and Resource Conservation: Rescission or Revision of Certain Requirements,” page 68-75. Available at: [https://www.catf.us/wp-content/uploads/2018/09/CATF\\_Filing\\_BLMOilGasDrilling\\_CitizenGroupComments.pdf](https://www.catf.us/wp-content/uploads/2018/09/CATF_Filing_BLMOilGasDrilling_CitizenGroupComments.pdf).

Given the virtual absence of sanctions for exceedances, it is not surprising that ND's approach has failed to solve the problem.

At the same time, the Commission has softened the requirements, making companies substantially less likely to be in violation, even as the problem has worsened. The current applicable goal is for operators to capture 88% of produced gas. In March 2019, however, operators flared about 20% of the produced gas, and at that time, operators had exceeded the target for the past 13 months in a row.<sup>99</sup>

For the first four years, the guidance stated that the policy goals were to reduce the flaring volume, duration, and number of wells.<sup>100</sup> In November 2018, however, the Commission changed the goals to "increase the volume of captured gas and reduce the percentage of flared gas," and to "incentivize investment in gas capture infrastructure," dropping the goals of reducing the volume and duration of flaring.<sup>101</sup> In addition, in April 2018 and November 2018, the Commission substantially expanded the quantities of flared gas that operators could remove from their compliance calculations.<sup>102</sup> In addition to the exemptions detailed above, operators may now remove: 60 days of flaring during initial production (versus 14 days); flaring where "gas gathering and processing capacity curtailment" is documented; flaring from existing wells bumped off the gathering system by new wells; and flaring under the following documented circumstances:

- landowner, tribal or federal right-of-way delays;
- midstream down-time for upgrades/maintenance;
- federal regulatory restrictions/delays
- safety issues;
- delayed access to electrical power; or
- possible reservoir damage.<sup>103</sup>

Also, outside of the "Bakken core area" or in a previously undrilled township, an operator may apply to designate gas from up to 6 horizontal wells as "stranded gas," which allows the operator to exclude the first year of production from those wells from compliance calculations and bars curtailment of those wells. It is difficult to conceive of situations in which an operator could not plausibly assert that one or more of the broad range exemptions apply.

## UTAH

Utah's regulatory restrictions on the flaring of associated gas are found in section [R649-3-20](#) of the Utah Administrative Code. That regulation allows for up to 1,800 Mcf of associated gas to be flared from an individual well on a monthly basis without approval. The regulation also allows for necessary flaring during production tests and for the "unavoidable or short-term" venting or flaring of gas without approval. "Unavoidable or short-term" venting or flaring includes (1) venting from storage tanks (unless the division determines that the recovery of such gas is warranted), and (2) venting or flaring during line failures, equipment failures, blowouts, or other emergencies if shutting in the well would cause waste or an adverse impact on the reservoir. Venting or flaring is allowed during well purging or evaluation tests for a period not to exceed 24 hours or a maximum of 144 hours in a month. If an operator wishes to vent or flare associated gas in circumstances not expressly provided for in the regulation (e.g., where the operator finds conservation of the gas to be not economically viable), then the operator may request approval for such venting or flaring from the state regulatory agency.

<sup>99</sup> Associated Press, North Dakota oil producers are wasting billions of cubic feet of natural gas (May 27, 2019) (<https://www.apnews.com/9855f0f8c6f146dbb1ebcc92cca3617a>).

<sup>100</sup> North Dakota Industrial Commission Order 24665 Policy/Guidance Version 102215 (Sept. 2015).

<sup>101</sup> North Dakota Industrial Commission Order 24665 Policy/Guidance Version 112018 (Nov. 20, 2018).

<sup>102</sup> North Dakota Industrial Commission Order 24665 Policy/Guidance Version 041718 (Apr. 17, 2018); North Dakota Industrial Commission Order 24665 Policy/Guidance Version 112018 (Nov. 20, 2018).

<sup>103</sup> North Dakota Industrial Commission Order 24665 Policy/Guidance Version 112018 (Nov. 20, 2018).



## **CALIFORNIA**

The California Public Resources Code prohibits the “unreasonable waste of natural gas.” [CAL. PUB. RES. CODE § 3300](#). The “blowing, release or escape of gas into the air” is considered prima facie evidence of “unreasonable waste.” Upon complaint or petition to the state regulatory agency showing probable cause that the unreasonable waste of gas is occurring or is threatened, the state regulatory agency will order a public hearing to determine whether such waste is in fact occurring or threatened. *Id.* §§ 3302, 3306. If the waste of gas is found to be unreasonable, the state regulatory agency will issue an order directing the waste to be discontinued or curtailed. *Id.* § 3308.

Even in the absence of the hearing process described above, the director of the state regulatory agency may institute an action to enjoin the unreasonable waste of gas when he or she determines that such waste is occurring. *Id.* § 3312.

## **MONTANA**

Montana regulations limit the flaring of associated gas from a well to 100 Mcf per day (after a 60-day well test period). [MONT. ADMIN. R. 36.22.1220](#). However, if the operator finds it necessary to flare more than 100 Mcf a day, it may seek approval for such additional flaring from the state regulatory agency. In order to obtain approval, the operator must submit an application “justifying” the need to flare more than 100 Mcf per day. The regulations identify certain information that must be included in the application (e.g., estimated gas reserves, proximity of the well to market, reinjection potential) and also ask for “any other information pertinent to a determination of whether marketing or not marketing or otherwise conserving the associated gas is economically feasible.”

Montana regulations require gas to be flared rather than vented when the volume of gas exceeds 20 Mcf per day for a period in excess of 72 hours. MONT. ADMIN. R. 36.22.1221. An operator may apply for a variance from this requirement. The application for a variance must include information on the potential for human exposure, the relative isolation of the location, restriction of access to the location, low gas volume, and low BTU content.

## **TEXAS**

The Railroad Commission of Texas – the state regulatory agency for oil and gas production in Texas – regulates the venting and flaring of gas pursuant to “Statewide Rule 32” ([16 TEX. ADMIN. CODE § 3.32](#)).

In general, Rule 32 requires operators to flare (rather than vent) all gas releases greater than 24 hours in duration. Released gas must be measured (or estimated) and reported to the Commission. Leaks and gas releases associated with storage tanks, well drilling, well completions, and blowdowns are exempted from the requirements of Rule 32. 16 TEX. ADMIN. CODE § 3.32(d). However, Rule 32 provides that the commission may require such releases to be flared for safety reasons.

Rule 32 authorizes the release of gas under the following circumstances: (1) gas may be flared for up to 10 producing days following initial completion, recompletion, or workover; (2) gas may be vented during unloading/clean-up for a period not to exceed 24 hours in a single event or 72 hours in one month; (3) gas may be released for up to 24 hours in the event of a full or partial shutdown of a gas gathering system, compression facility, or gas plant servicing the well (the operator may request an extension of the 24-hour period); and, (4) low pressure separator gas may be released up to 15 Mcf/day/well or 50 Mcf/day/lease. 16 TEX. ADMIN. CODE § 3.32(f)(1).

The Commission may authorize additional venting or flaring when the operator makes a showing of the “necessity of the release.” 16 TEX. ADMIN. CODE § 3.32(f)(2). Situations where additional venting or flaring is a “necessity” include: (1) cleaning of well solids or fluids; (2) unloading excess formation fluid buildup; releases of low-pressure gas that cannot be captured due to “mechanical, physical, or economic impracticality”; and (3) (for casinghead gas only) the unavailability of a gas pipeline or other marketing facility.

## **ALASKA**

Alaska regulations place significant restrictions on venting and flaring. [20 ALASKA ADMIN. CODE § 25.235](#). Under those regulations, gas that is vented or flared constitutes waste, except that: (1) flaring or venting for up to one hour as the result of an emergency or operational upset is authorized for safety purposes; (2) flaring or venting for up to one hour as the result of a planned lease operation is authorized for safety purposes; (3) flaring pilot or purge gas to

test or fuel the safety flare system is authorized for safety, and (4) de minimis venting of gas incidental to normal oil field operations is authorized.

### Alaska

In response to high rates of flaring, Alaska adopted regulations in the 1970s that largely prohibit venting or flaring. All flaring or venting is waste except:

- (1) flaring or venting for no more than 1 hour needed for safety due to either “an emergency or operational upset,” or “a planned lease operation;”
- (2) “flaring pilot or purge gas to test or fuel the safety flare system;”
- (3) “de minimis venting . . . incidental to normal oil field operations;” and
- (4) flaring or venting with approval from the commission for well testing before regular production.

The commission may also authorize flaring or venting for a period of more than 1 hour based on a report describing why the gas was flared or vented, the beginning and ending time, the volume, and actions taken to minimize the volume, if the flaring or venting is:

- (1) “necessary for facility operations, repairs, upgrades or testing procedures;”
- (2) required by “an emergency that threatens life or property,” unless failure to operate in a safe and skillful manner causes the emergency; or
- (3) “necessary to prevent loss of ultimate recovery.”

In addition, operators are required to act “in accordance with good oil field engineering practices and conservation purposes to minimize the volume of gas released, burned, or permitted to escape in the air.”

According to the Alaska Oil and Gas Conservation Commission, the effect of the prohibition on venting and flaring has been widespread reinjection of associated gas for conservation and oil recovery, and Alaska estimates that roughly 0.4 percent of gas production is flared.<sup>104</sup>

It should be noted that the vast majority of gas produced on the north slope of Alaska is stranded because there is no pipeline to take the gas to market, and north slope production exceeds local demand for power generation and petroleum industry needs. Nevertheless, Alaska has effectively banned routing flaring as a means to dispose of gas. Most north slope gas is re-injected (and therefore has some value for maintaining reservoir pressure).

### **OKLAHOMA**

Oklahoma regulations allow an operator to vent or flare up to 50 Mcf/day without a permit where it is not economically feasible to market the gas. [OKLA. ADMIN. CODE § 165:10-3-15\(b\)](#). Operators are allowed to “blow down” a well for up to 72 hours, and operators may vent or flare during initial flowback following completion or recompletion for a 14-day period (which may be extended by up to 30 days) if it is not economically feasible to market the gas. OKLA. ADMIN. CODE § 165:10-3-15(a), (d), (e).

An operator may apply for a permit to vent or flare in excess of 50 Mcf/day where “it is not economically feasible to capture the gas.” OKLA. ADMIN. CODE § 165:10-3-15(c). The operator’s application for the permit to flare must list the maximum daily volume of gas to be vented or flared.

### What are examples of process changes/modifications that reduce or eliminate emissions/waste from this equipment or process?

It is important to note that the best solution to flaring is always having a sales pipeline. However, as an industry we continue to investigate new techniques and technologies that reduce flaring. An example is the onsite generation of

<sup>104</sup> BLM, Waste Prevention Rule; proposed rule at 6633 (citing telephone communication with Alaska Oil and Gas Conservation Commission, April 30, 2015); see also, Hoffman et al., The Benefits of Reinjecting Instead of Flaring Produced Gas in Unconventional Oil Reservoirs, Unconventional Resources Technology Conference, 1640, 1642 (Aug. 25-27, 2014).

power production using produced hydrocarbon vapors as fuel. NM electric power provider's willingness to accept distributed generation from oil and gas sites with stranded gas or limited takeaway capacity could allow the gas to be utilized to support the electrical demands of the state, thus offsetting flaring. Distributed generation could allow for on-site equipment to utilize electricity reducing demand on diesel generators or the grid and supplement the grid with power generated in excess of site demand.

Some operators have pilot programs planned to inject gas for Enhanced Oil Recovery projects. Re-injecting the gas versus putting in the pipeline, could help alleviate some of the pipeline capacity constraints.

Planning the location and timing of the development of new/recompleted wells based on the projected or confirmed present and future availability of takeaway capacity allows operators of such wells to largely avoid routine flaring of associated gas. In making decisions about where to develop the next new wells or set of wells, or in making decisions on whether and when to pursue and sign agreements with midstream companies, the degree to which operators explicitly weigh takeaway capacity availability is unclear. If, however, operators were to optimize their development planning and processes around maximizing capture of associated gas, along with return on capital etc., it appears highly likely that operators would be very successful in increasing gas capture.

For existing wells, operators can add compression to counter the effect of higher pressure new wells pushing lower pressure older wells off the gathering system. While, as noted below, there are limits to the overall pressures and throughputs allowed on gathering systems, adding compression to boost the pressure of gas from lower pressure wells is a reasonable low cost strategy that operators already use at times and might use more frequently if flaring were not an extremely low cost alternative.

Operators providing information on planned development and expected volumes and timing to midstream operators can facilitate midstream investment aligned with future production and minimize any time lag between increased volumes of associated gas production and expansion of takeaway capacity.

When wells are first completed, the pressure into the gas sales line may exceed the gas sales pressure of neighboring well locations. It is not possible to create a system to manipulate well pressures to ensure that all leases connected to a given gas pipeline have access to it. Also, because leases may consist of federal and non-federal leases, where the lateral section of the horizontal well may pass through and drain more than one mineral estate, all royalty owners in that lateral would have an interest in the production. Therefore, it would be an inaccurate assumption that a gas system can be pressure balanced in the form of curtailment of production as a means of preventing loss associated with lack of access to pipeline capacity. Also, the MAOP of gathering lines limits the amount of compression that can be introduced to ensure gas is being produced into the gathering system.

Entering into contractual arrangements with midstream operators that guarantee access to the gathering system and processing facilities would provide far greater certainty regarding available takeaway capacity for both new and existing wells. Alternatively, or in addition, larger operators could directly invest in additional takeaway capacity.

Operators can coordinate with midstream companies regarding planned maintenance and arrange for reduced production or temporary alternative on-site capture technologies, such as CNG trucking, during those periods.

## **Technology Alternatives:**

List of technology alternatives with link to information or contact information for the company/developers.

Name/Description of Technology	Link (and contact info for company if available)	Availability	Feasibility	Cost Range (choose one)
		In use <u>or</u> in development		Low Medium High
University of North Dakota's Energy & Environmental Research Center provides a database containing vendor-supplied technical and economic information regarding gas utilization technologies	Database <a href="#">Link</a> Report <a href="#">Link</a>	Varies	Varies	Varies
Department of Energy's funded work with Houston Advanced Research Center is evaluating technologies that address flaring. An update of HARC's 2015 white paper, <i>'Recommendations to Address Flaring Issues, Solutions and Technologies'</i> will be published in Fall, 2019.	<a href="#">Link</a>			
Auto igniters for new flares	<a href="#">Link</a>	In use	Feasible	Low
Auto Igniters (including requirements to retrofit older existing flares)	<a href="#">Link</a>	In use in some flare designs, but not all	Feasible for some flare designs, but not all	Medium to high
NGL recovery		In use – e.g., in ND	Scaleable; effective; best for rich gas; reduces only a portion of the associated gas. Well pads designed for hydraulic fracturing equipment will have additional available space when that equipment is removed.  Residue gas contains methane, ethane and small amounts of propane; too "rich" for natural gas vehicles. Equipment footprint and spacing requirements often	Low to negative  High

			present challenges, especially after interim reclamation Increases product storage and truck traffic at production site.	
Compressed natural gas (CNG) transported to processing plant or other input point on gathering system by truck.		In use Operating at 5 or more well sites in 2015.	Scalable; works for all gas compositions; best for wells within 20-25 miles of gathering system/processing plant access; can address all of the associated gas.  CNG marketed for vehicle engines is challenged as infrastructure is lacking and fuel standards require high-purity methane. CNG viability vs. diesel is dependent upon CNG transportation costs.	Low to negative  High
Gas to power generation for on-site use		In use	saleable; effective; best with lean gas; can pair with NGL recovery; uses only a portion of the associated gas.  Reliability of generation system is critical to ensuring power for production equipment. On well by well basis cannot capture all gas to generate power.	Low to negative  High
Gas to power generation for grid		In use	Requires multiple wells for viable scale and location near grid  Low price for power makes economics of grid-interconnect challenging at the wellsite. NM electric power provider's	Low to negative  High

			willingness to accept distributed generation is not widespread.	
Reinjection of associated gas for EOR		In use At least 5 producers in TX; <sup>105</sup> long-term use in Alaska	Long-established technology for conventional wells. Requires available depleted oil fields or other reservoirs, capital investment, compressors, possibly additional flow lines; effectiveness depends on particular formation. <sup>106</sup>	Low to negative Profitable where effective in boosting oil recovery (e.g., potential for “significant” additional recovery; “30-70% gain in oil output from older wells”). <sup>107</sup>
Reinjection of associated gas for storage		Long-term use in AK	Long-established technology. Requires available depleted oil fields or other reservoirs, capital investment, compressors. If reinjected into a different reservoir (salt cavern, aquifer) would require new well.	??
Reinjection solutions that have been presented to NMOCD. These may require development of appropriate permitting procedures.				

What technology alternatives exist to reduce or detect emissions? Please list all alternatives identified along with contact information for further investigation of this technology or process.

It is important to note that the best solution to flaring is always having a sales pipeline. Industry proactively employs science, innovation, technology, and collaboration to prevent waste and reduce environmental impacts. Some oil and

<sup>105</sup> Energywire, Texas’ gas glut is so bad, drillers pump it down wells (June 10, 2019).

<sup>106</sup> Hoffman et al., The Benefits of Reinjecting Instead of Flaring Produced Gas in Unconventional Oil Reservoirs, Unconventional Resources Technology Conference, 1640, 1645 (Aug. 25-27, 2014); Energywire, Texas’ gas glut is so bad, drillers pump it down wells (June 10, 2019).

<sup>107</sup> Hoffman et al., The Benefits of Reinjecting Instead of Flaring Produced Gas in Unconventional Oil Reservoirs, Unconventional Resources Technology Conference, 1640 (Aug. 25-27, 2014); Energywire, Texas’ gas glut is so bad, drillers pump it down wells (June 10, 2019); Carbon Limits, Improving utilization of associated gas in US tight oil fields, Appendix 2, 10 (April 2015).

gas companies have committed to voluntary initiatives to reduce flaring without regulatory requirements. Companies also utilize some of these technology alternatives in the EERC and HARC databases to increase the destruction and removal efficiency of flares and identify beneficial or lease uses of gas in oil and gas operations.

There are a number of technologies in use today that can assist companies with gathering associated gas that might otherwise be flared in the absence of adequate infrastructure. These technologies utilize mobile conditioning and processing equipment to produce a marketable product transportable by truck:

- Natural Gas Liquids (NGL) Skids – liquids (e.g. C3+) are extracted from the gas phase (typically through mechanical refrigeration or JT (Joule-Thompson) effect) and hauled by truck off location, leaving a leaner residue gas phase on site; liquids are delivered to a plant or pipeline for sales.
- Compressed Natural Gas (CNG) – gas is compressed to reduce shipping volume and transported in special trailers where it can be delivered to a plant or used for power generation for production operations or hydraulic fracturing or other gas use.
- Liquefied Natural Gas (LNG) – lean gas is cooled to approximately -260°F to convert to a liquid state so it can be transported in special trailers to a gas plant for sales or to a remote location for power generation or other gas use; the liquid will be re-gasified at these destinations.

Another example is the onsite generation of power production using produced hydrocarbon vapors as fuel mentioned above. See section above for more details.

Auto igniters can also assist in maintaining the pilot. This technology replaces the intermittently or continuously burning flare pilots with electrical sparking pilots similar to a modern gas stove. These sparking pilots require low electrical power that can be supplied from a battery with solar recharge in remote sites. In addition to using electronic flare ignition devices for pilots, facilities may also install sensors to detect the pilot flame and shut off fuel gas if the pilot is extinguished.

#### What are the pros and cons of the alternatives?

Each technology alternative has its own pros and cons. Featured below are the pros and cons of two specific alternatives.

##### **Natural Gas Liquids Skids**

It is only possible to install temporary capture equipment (such as a natural gas liquids (NGL) extraction skid) on locations that are large enough to accommodate the NGL skid, ancillary equipment, and tanks and still meet spacing and safety requirements.

NGL Skids will not operate at very low flows (there is a minimum turndown rate), meaning that these units cannot reasonably be used to process the sometimes small flare volumes occurring when sales lines are at maximum capacity. Gas production may quickly decline to rates much lower than the temporary capture equipment's minimum turndown rate necessary for operation. When the production rate declines, the unit must be moved to a new location, which incurs relocation costs and requires an active drilling program to provide new pads with adequate volumes to justify equipment deployment and operation based on sufficient gas production. Otherwise the equipment would need to be on standby, and operators would be required to pay significant costs to guarantee immediate deployment when the equipment is necessary.

Furthermore, as referenced in the North Dakota's Energy and Environment Research Center study, it has been shown that NGL operations in the Bakken have poor runtime under some operational scenarios.

[https://undeerc.org/flaring\\_solutions/pdf/CW\\_Tech\\_Study\\_April-2013.pdf](https://undeerc.org/flaring_solutions/pdf/CW_Tech_Study_April-2013.pdf)

Due to high temporary capture equipment cost, economics may be poor, especially during periods of low gas and NGL commodity pricing. Third party companies offering turnkey temporary capture solutions often charge high premiums to cover capital and operating costs that will not be offset by liquids revenue in today's market. Furthermore, pairing two or more technologies such as NGL and CNG for liquids recovery and sales of the gas may compound the economic infeasibility of temporary capture technology. This is a case-by-case assessment for individual operators.

Liquid recovery equipment, including compression and refrigeration hardware for NGL, CNG, or LNG, is not designed to operate as an interruptible service. When employed as a backup to a primary gas gathering pipeline, all inlet gas supply to the temporary capture equipment is interruptible. The equipment will not function properly with an interruptible gas supply and will shut down when the gas supply is interrupted. Most liquid recovery equipment requires an operator onsite to manually restart the equipment following a shutdown of the gas supply, meaning that widespread usage of liquid recovery units as a backup to the primary gas gathering pipeline would require an unreasonable number of operators, which is another factor potentially impacting economics.

In addition to requiring a constant gas supply, liquid recovery equipment also requires a consistent rate of gas supply. Due to fluctuating sales capacity on the gathering pipelines, the gas stream to the liquid recovery equipment is highly variable and would not allow for proper equipment function when temporary capture equipment is used for capturing any excess gas not sold via permanent gas gathering lines. Liquid recovery equipment relies on trucking to remove liquids offsite, which can be unreliable during wintertime. In addition, trucking is an expensive mode of transportation, particularly relative to low liquids prices.

NGL, CNG, or LNG produced would still need to find an end market to absorb the product. For example, NGLs will still have to be fractionated. Gas plants are not normally designed to handle large and frequent truck volumes of NGLs. CNG and LNG will have to find a use or available reinjection point (which then requires further equipment).

#### **Onsite Electrical Power Generation**

Onsite electrical power generation, in excess of that required onsite, can only be used where there is acceptance by electrical power providers of electrical power generated by burning hydrocarbon vapors on-site at production facilities. The power produced would help alleviate electrical power supply constraints in areas where crude oil and natural gas production activities place the highest demands on the grid.

NM electric power provider's willingness to accept distributed generation from oil and gas sites with stranded gas or limited takeaway capacity could allow the gas to be utilized to support the electrical demands of the state, thus offsetting flaring. Distributed generation could allow for on-site equipment to utilize electricity, reducing demand on diesel generators or the grid and supplement the grid with power generated in excess of site demand.

#### **Reinjection and on-site capture technologies**

Reinjecting associated gas for storage and/or EOR avoids the waste of such gas, except for the small portion that may be released during production using EOR, and EOR can significantly boost oil production.<sup>108</sup> Reinjection for EOR has long been used in conventional oil production, and is currently being used by at least five producers of tight oil in Texas.<sup>109</sup> It requires availability of appropriate oil reservoirs or other reservoirs. Operators would have to incur the capital costs of developing an injection well (or adapting older wells to be used as injection wells), as well as operating costs of

---

<sup>108</sup> Hoffman et al., The Benefits of Reinjecting Instead of Flaring Produced Gas in Unconventional Oil Reservoirs, Unconventional Resources Technology Conference, 1640 (Aug. 25-27, 2014); Energywire, Texas' gas glut is so bad, drillers pump it down wells (June 10, 2019).

<sup>109</sup> Texas' gas glut is so bad, drillers pump it down wells (June 10, 2019).



compressors.<sup>110</sup> For EOR, some make up gas and additional flow lines might also be needed at single well sites.<sup>111</sup> The effectiveness for EOR depends upon the particular formation targeted to enhance oil production.<sup>112</sup> Reinjection for EOR could be profitable where effective in boosting oil recovery. One study found the potential for “significant” additional recovery, a payback period of 7 years, and a 17% rate of return at \$55/barrel oil.<sup>113</sup> Recent use in the Eagle Ford has shown a “30-70% gain in oil output from older wells,” and that it “can potentially extend crude production volumes in older wells by 18 to 24 months.”<sup>114</sup>

Operators can also use alternative on-site capture technologies to beneficially use the gas on-site or reduce the flared volumes. Proven technologies already in use include:

- NGL recovery, which reduces the volume/intensity of the flare, while recovering higher value product for sale;<sup>115</sup>
- Compressed natural gas (CNG) trucking;<sup>116</sup> and
- Gas to power generation, at a local or grid level.<sup>117</sup>

These technologies would not replace traditional gas gathering, but give operators flexibility in finding ways to utilize gas from a pad. For example, if build-out of a gathering system is delayed, these portable approaches could be used to utilize gas in the gap period.

NGL recovery is portable, scalable and low or negative cost. It works best with rich gas. It is only a partial solution, as it eliminates only a portion of the flare (from 5% to 21% depending on the type of NGL system and whether it is a single or multiple wells), but it also works well in combination with other alternative technologies, such as power generation for local load, because the remaining gas is more suitable for engines and compressors. NGL recovery can use a simpler or more complex system. A simpler system is smaller and requires less capital, but also eliminates less of the flaring volume.<sup>118</sup> If allowed, the use of NGL recovery on wells selling gas into gathering systems could also increase the throughput of the gathering system by reducing liquids drop-out in gathering pipelines.

With respect to potential space constraints noted above, the well sites at issue are designed to accommodate fracking equipment at the time of completion/recompletion, which means additional space is available on most sites. However, safety setbacks do impact space constraints for the various equipment types. It is unclear how many sites would be precluded from deploying this option due to space constraints.

With respect to concerns noted above regarding decline rates, NGL skids are designed to be mobile and moved from site-to-site to address that reality, and many or most operators in the Permian do have “active drilling programs,” which means that equipment could be moved to new sites if the operator continues to need to reduce flaring volumes.

<sup>110</sup> Carbon Limits, Improving utilization of associated gas in US tight oil fields, Appendix 2, 10 (April 2015)

<https://www.carbonlimits.no/project/improving-utilization-of-associated-gas-in-us-tight-oil-fields/>

<sup>111</sup> Hoffman et al., The Benefits of Reinjecting Instead of Flaring Produced Gas in Unconventional Oil Reservoirs, Unconventional Resources Technology Conference, 1645 (Aug. 25-27, 2014);

<sup>112</sup> Hoffman et al., The Benefits of Reinjecting Instead of Flaring Produced Gas in Unconventional Oil Reservoirs, Unconventional Resources Technology Conference, 1645 (Aug. 25-27, 2014); Energywire, Texas’ gas glut is so bad, drillers pump it down wells (June 10, 2019).

<sup>113</sup> Hoffman et al., The Benefits of Reinjecting Instead of Flaring Produced Gas in Unconventional Oil Reservoirs, Unconventional Resources Technology Conference, 1640 (Aug. 25-27, 2014);

<sup>114</sup> Energywire, Texas’ gas glut is so bad, drillers pump it down wells (June 10, 2019);

<sup>115</sup> Carbon Limits, Improving utilization of associated gas in US tight oil fields, 27 (April 2015).

<sup>116</sup> Carbon Limits, Improving utilization of associated gas in US tight oil fields, 33 (April 2015).

<sup>117</sup> Carbon Limits, Improving utilization of associated gas in US tight oil fields, 36 (April 2015).

<sup>118</sup> Carbon Limits, Improving utilization of associated gas in US tight oil fields, 27 (April 2015).

Note that cost of transport can create a significant discount to benchmark prices and negatively impact an already uneconomic technology.<sup>119</sup>

Note that the study cited as support for the previous sentence concludes: “NGL removal will not single-handedly reduce the number of flares, but it will reduce the overall quantity of flared gas and will create a viable secondary revenue stream for wells for which gathering pipelines have not yet been installed. In fact, several companies are now pursuing this business opportunity within the Bakken region.”<sup>120</sup>

CNG trucking is portable, scalable and low or negative cost. It works with all gas compositions, and is most feasible at wells that are within 20-25 miles of a processing plant or other point that the gas can be put into the gathering system. It can reduce the flared volume by 91% to 98%, depending on the composition of the gas and whether it is deployed for a single or multiple wells.<sup>121</sup> This option would be most effective not as an intermittent backup for temporary upsets in the gathering system, but rather as a longer term (but not long-term) alternative if a planned capacity increase is delayed for a period.

Gas to power generation for on-site loads is portable, scalable and low or negative cost, with significant cost savings from substitution for diesel. It works best with lean gas, and thus can be coupled with NGL recovery. It can reduce the flare volume by an estimated 18% to 22%, depending on the electricity load of the site, and can use either a reciprocating engine or gas turbine.<sup>122</sup> Generation for use on-site can also support other methane emission reduction efforts such as using electric power rather than pneumatic power to run equipment such as pumps and controllers. In addition, generation for local use might potentially help provide electricity used in gathering systems as well.

Gas to power generation for the grid is low or negative cost (due to electricity generation revenues) where deployable, but requires a larger quantity of gas from multiple wells and proximity to the grid.<sup>123</sup>

Additional alternatives that are less well-proven but have potential include: ammonia production; mini gas-to-liquids – methanol; mini gas-to-liquids – Fischer Tropsch; and mini-liquefied natural gas.<sup>124</sup>

Better development planning, communication with midstream companies, and focus on optimizing the timing of new production with the availability of takeaway capacity offers the potential for substantial reductions in flaring, at potentially low or negative costs. To the extent that this is implemented through better communication with midstream operators and realignment of how the operator prioritizes the next project for development, it could require managerial resources. Where aligning new production with takeaway capacity availability may involve some delays and/or additional investment in gathering systems, there is potential cost to operators. Similarly, entering into contractual arrangements to ensure access to the gathering system would impose some costs. Some of these costs would be recouped by selling rather than flaring the gas.

As discussed above, all of the technological alternatives discussed in detail here use proven technologies that are in use or have been used by some operators. Some technological alternatives work best for rich or lean gas, while others work with all gas compositions. All of the alternatives discussed above (except power generation for the grid) can be deployed at single well sites or scaled up to multiple well sites. Analyses indicate that each of these alternatives have low to negative costs. Some, such as NGL recovery or local power generation are only partial

<sup>119</sup> [https://undeerc.org/flaring\\_solutions/pdf/CW\\_Tech\\_Study\\_April-2013.pdf](https://undeerc.org/flaring_solutions/pdf/CW_Tech_Study_April-2013.pdf)

<sup>120</sup> EERC, End Use Technology Study – An Assessment of Alternative Uses for Associated Gas, 90-91 (April 2013) ([https://undeerc.org/flaring\\_solutions/pdf/CW\\_Tech\\_Study\\_April-2013.pdf](https://undeerc.org/flaring_solutions/pdf/CW_Tech_Study_April-2013.pdf)).

<sup>121</sup> Carbon Limits, Improving utilization of associated gas in US tight oil fields, 33 (April 2015).

<sup>122</sup> Carbon Limits, Improving utilization of associated gas in US tight oil fields, 36 (April 2015).

<sup>123</sup> Carbon Limits, Improving utilization of associated gas in US tight oil fields, Appendix 1, 7 (April 2015).

<sup>124</sup> Carbon Limits, Improving utilization of associated gas in US tight oil fields at 11-12 (April 2015).

solutions, but if low cost, that would still be worthwhile, and they would be more effective in combination. Some alternatives are relatively technologically straightforward, such as NGL recovery, CNG trucking, and power generation, while the effectiveness of gas reinjection for EOR in tight oil formations appears to depend upon the specific formation in which it is used and may well improve with additional testing and refinement.

Below is a summary of the 2015 market prices assumed in the Carbon Limits report as compared to current market prices:

	Carbon Limits <sup>125</sup>	U.S. Energy Information Administration
Natural Gas	\$4.00/MMBtu	\$1.44/MMBtu <sup>126</sup> - Southwest
Natural Gas Liquids	\$13/MMBtu	\$4.62/MMBtu <sup>127</sup> - July 2019

What is needed and available for new wells?

See Table

What is needed and available for existing wells?

See Table

What technology alternatives exist for this equipment or process itself?

See Table

What are the pros and cons of the alternatives?

See Table

### Costs of Methane Reductions:

What is the cost to achieve methane emission reductions?

As of August 2019, the EERC's Flaring Solutions database contained 33 companies with technologies in the following categories. Approximately 50% of these companies have had units deployed at some point in time.

- NGL recovery
- Power production
- CNG or LNG production
- Gas conversion to chemicals or fuels

Below is a summary of the EERC NGL Liquid Recovery Economics for the Bakken from August 2019. The Key Challenge: Low NGL and ethane value, and large distance from Bakken formation to market (transportation cost)

	August 2019
Total gas treated <sup>1</sup>	1000 mcf

<sup>125</sup> Carbon Limits, Improving utilization of associated gas in US tight oil fields at 57 (April 2015).

<sup>126</sup> <https://www.eia.gov/todayinenergy/prices.php>

<sup>127</sup> [https://www.eia.gov/dnav/ng/hist/ngm\\_epg0\\_plc\\_nus\\_dmmbtum.htm](https://www.eia.gov/dnav/ng/hist/ngm_epg0_plc_nus_dmmbtum.htm)

NGL Recovery <sup>2</sup>	3 gal/mcf
NGL Value <sup>3</sup> (net back)	<\$0.20/gal
Annual costs <sup>4</sup> (lease, mobilization, royalty)	\$569,520
Annual NGL Revenue <sup>5</sup>	\$196,800
Net Profit <sup>6</sup> (Loss)	(\$372,720)

Assumptions:

<sup>1</sup> Larger systems have few locations where 100% capacity is achievable. Smaller systems suffer from economy of scale.

<sup>2</sup> Higher recovery efficiency typically results in higher ethane content and value deduction.

<sup>3</sup> NGL over supply and cost of transport can create a significant discount to benchmark prices.

<sup>4</sup> Annual costs ranging from \$0.75-2.00/mcfd capacity (\$22,500/mo. - \$60,000/mo); three mobilizations/yr at \$60k each; and royalty of 15% on NGLs sold.

<sup>5</sup> Annual NGL revenue assumes 90% capacity factor

<sup>6</sup> NGL recovery systems provide challenged economics under the best conditions.

[https://undeerc.org/flaring\\_solutions/pdf/CW\\_Tech\\_Study\\_April-2013.pdf](https://undeerc.org/flaring_solutions/pdf/CW_Tech_Study_April-2013.pdf)

Note that the scenario presented above (recovery of 3000 gallons of NGL per day for a year, with an annual cost of \$373,000, rather than combusting those NGLs if left in the gas sent to the flare) would prevent significant amounts of pollution. Assuming a density of NGLs of ~0.6 (relative to water) and that the NGL is 83% carbon by weight (based on the elemental ratio of butane), flaring 3000 gallons of NGLs a day for one year would emit 7,500 tons of carbon dioxide, assuming perfect combustion. (To the degree combustion is not perfect, the flare is emitting other pollutants aside from CO<sub>2</sub>.)

As discussed above, more and better coordination with midstream companies and engaging in development planning to better align the location and timing of new associated gas production with available takeaway capacity are approaches to reducing venting and flaring that operators can use at negative cost. If operators delay production at wells where, for example, projected takeaway capacity has not yet become available, that will impose costs, with the magnitude depending on multiple economic factors regarding the financing of the well, as well as the length of delay. If, however, as a technical matter, operators can deploy other alternative technologies such as NGL recovery, CNG trucking, gas to power generation, or reinjection at a lower cost than the cost imposed by delaying production, those alternative costs, rather than the cost of delay, should be considered the applicable cost of ensuring capture in such situations.

As noted above, for reinjection for EOR, one study found the potential for “significant” additional recovery, a payback period of 7 years, and a 17% rate of return at \$55/barrel oil.<sup>128</sup> Recent use in the Eagle Ford has shown a “30-70% gain in oil output from older wells,” and that it “can potentially extend crude production volumes in older wells by 18 to 24 months.”<sup>129</sup>

Carbon Limits’ report on alternatives to flaring for tight oil formations.<sup>130</sup> provides extensive cost information for CNG trucking, NGL removal, and on-site electrical generation, where the cost of the measure depends upon many factors such as the amount of gas available at the site, composition of the gas, location and configuration of the sites, etc.

<sup>128</sup> Hoffman et al., The Benefits of Reinjecting Instead of Flaring Produced Gas in Unconventional Oil Reservoirs, Unconventional Resources Technology Conference, 1640 (Aug. 25-27, 2014);

<sup>129</sup> Energywire, Texas’ gas glut is so bad, drillers pump it down wells (June 10, 2019);

<sup>130</sup> [http://www.catf.us/wp-content/uploads/2015/04/CATF\\_Pub\\_PuttingOuttheFire.pdf](http://www.catf.us/wp-content/uploads/2015/04/CATF_Pub_PuttingOuttheFire.pdf)

Using data from the Carbon Limits study, MJ Bradley and Associates (MJB&A) calculated the costs of the flaring rule that BLM proposed in early 2016. They concluded that CNG trucking would be an appropriate way for operators to comply with the rule, and calculated that costs of the rule assuming that all capture of gas (relative to current flaring levels at BLM leases) would occur via CNG trucking. This is a conservative assumption, since many operators will get pipelines hooked up to wells under a gas capture standard, and pipeline transport will be more efficient than CNG trucking in many cases. MJB&A also used conservative (high) cost assumptions for CNG trucking. They found that the standards, as BLM proposed them, would have low or negative cost for operators (maximum *nationwide* cost to operators of the BLM gas capture requirement would have been \$1.5 million, according to MJB&A). However, we note that MJB&A was using a discounted projection of Henry Hub prices for gas, which are higher than current Waha hub prices. Finally, MJB&A found that when avoided damages from climate pollution were included (i.e., using the social cost of CO<sub>2</sub>, the flaring standard BLM proposed would have an overall benefit to society of about \$100 million per year.

When BLM finalized the 2016 flaring standard, the agency modeled the costs and benefits of the finalized standard (which was slightly modified from the proposed standard that MJB&A analyzed).<sup>131</sup> BLM's analysis assumed that the predominant response by operators to the flaring standard would be CNG trucking (but unlike MJB&A's analysis, BLM did not assume that 100% of operator response would be CNG trucking). BLM also used costs from the Carbon Limits report for the CNG trucking portion of operator response. Depending on discount rate, and neglecting the societal benefit from reduced pollution, BLM estimated that over a ten year period, the rule would have had a low benefit to operators if CNG trucking costs are low, and would have had a net nationwide cost to operators of ~\$250 million over ten years if CNG trucking costs are high.

What would be the implementation cost?

For new wells?

See Technology Alternatives Above

For existing wells?

See Technology Alternatives Above

Are there low-cost solutions available?

See Technology Alternatives Above

If a solution is high-cost, why is that the case?

See Technology Alternatives Above

Are there additional technical analyses needed to refine benefits/costs estimates?

---

<sup>131</sup> See pages 45-50 of BLM's Regulatory Impact Analysis for 2016 Final Venting and Flaring Rule (available here: <https://www.regulations.gov/document?D=BLM-2016-0001-9127>).

### 3. IMPLEMENTATION

For each piece of equipment or process, please consider the following questions and add other relevant information. If relevant, please identify if the answers are different for large company and small company requirements or are different for well type or basin.

#### Implementation Feasibility:

What is the feasibility of implementation (availability of required technology or contractors, potential permitting requirements, potential for innovation)?

It should be noted that the various technologies are engineered solutions and are site specific with respect to current facility design, economics and technical feasibility.

See Technology Alternatives Above

See discussion of better planning and alternative technologies above, as well as the discussion of the pros and cons of alternatives.

What is the useful life of equipment?

See Technology Alternatives Above

What are the maintenance and repair requirements for equipment required for methane reduction?

See Technology Alternatives Above

How would emissions be detected, reductions verified and reported?

Avoided venting and flaring would reduce reported venting and flaring volumes. There would not be a need to separately report the volumes avoided by specific activities.

### 4. CHALLENGES AND OPPORTUNITIES TO ACHIEVE METHANE REDUCTION IN NEW MEXICO

For each piece of equipment or process, please consider the following questions and add other relevant information. If relevant, please identify if the answers are different for large company and small company requirements or are different for well type or basin.

What regulatory gaps exist for this equipment or process? Are there regulatory gaps filled by the proposed implementation?

When reporting of flared volumes (F code) was rolled out, the only guidance given to operators was “The new code “F” is to be used to report the volume of gas that is flared on a well basis, or total volume if flared at a common battery or gathering system and reported under one point of disposition.” There was no formal standard or protocol that detailed what types of flaring to report or how to measure or estimate flared volumes.

Also, C-115s are a requirement for operators of oil and gas wells. Midstream flaring is either permitted or reported to NMED.

Because the aforementioned technology alternatives may not be cost effective in all instances, regulatory incentives should be considered to assist in promoting their use. For example, North Dakota recognizes the following as surplus gas being utilized in a beneficial manner that may be considered as captured gas:

- Equipping the well(s) with an electrical generator that consumes surplus gas
- Equipping the well(s) with a system that intakes the surplus gas and natural gas liquids volume from the well for beneficial consumption by means of compression to liquid for use as fuel, transport to a processing facility, production of petrochemicals or fertilizer, conversion to liquid fuels, separating and collecting the propane and heavier hydrocarbons.
- Equipping the well(s) with other value-added processes as approved by the Director which reduce the volume or intensity of the flare by more than 60%.

Where do conflicting priorities exist between NMED, EMNRD, and NMSLO? Are there opportunities for coordination between these agencies?

The oil and natural gas industry (industry) and royalty interest owners, including the State of New Mexico have an aligned and vested interest in capturing the natural gas produced. The industry has invested billions of dollars, and continues to invest in infrastructure to capture the gas, gather it from thousands of well sites, and transport it through pipelines to sales. When gas cannot be gathered and transported to market for sales, industry has made further substantial investments in flare and combustion devices and gas capture technology to minimize its impact to the environment.

Since some of the flaring is temporary, if there are air permitting requirements for some of these alternative technologies (NGL Skids, etc.), the timing for NMED air permitting approval may not accommodate timely placement of the equipment.

NM contains approximately 27 million acres of Federal Land. The Bureau of Land Management (BLM) manages all permitting of ROWs on federal land. The NEPA process is triggered when a federal agency develops and/or is presented with a proposal for a federal action (e.g., ROW application). There are different levels and scope of a NEPA Review: Environmental Impact Statement (EIS) is the most rigorous; Environmental Assessment (EA) is the most common, and Categorical Exclusions (CEs). The level of NEPA review required will determine the timeframe for approval, which can vary greatly. Consequently, the timing of ROW approval hinders the construction of infrastructure that is needed to reduce flaring.

NMSLO is proposing a rule for cultural properties on trust land which includes an element of landscape planning at the same time it has implemented a policy related to species surveys.

While the NM statute and regulations prohibit waste of gas, as discussed above, the current regulations allow for almost unlimited exceptions and have failed to adequately control venting and flaring.

In addition, the current regulations do not clearly require operators to flare in lieu of venting in all situations in which flaring is possible (exceptions should be limited to situations such as emergencies, where quantities are too small to route to a flare, or where flaring is prohibited (such as due to wildfire risk)). 19.15.18.12.F. NMAC states that "Pending connection of a well to a gas-gathering facility, or when a well has been excepted from the provisions of Subsection A of 19.15.18.12 NMAC, the operator shall burn all gas produced and not used, and report the estimated volume on form C-115." Additionally, BLM's 2018 rule in §3179.6(b). "The operator must flare, rather than vent, any gas that is not captured, except under certain circumstances."

The current regulations require operators to submit a gas capture plan, but the form provided has failed to generate meaningful or effective plans.<sup>132</sup> It requires a simple statement that the gas will be connected to a gas transporter (who is supposed to be identified) and that the operator believes the system can take the gas, but there is nothing that would require an operator to make a real inquiry or analysis of whether the system is expected to have available capacity at the time the well is to come on line, much less provide any such assurance. There is also a section titled “Alternatives to Reduce Flaring” which lists “alternatives considered from a conceptual standpoint to reduce the amount of gas flared.” The form itself lists the alternatives *along with reasons to reject them* (e.g., for NGL Removal the form states “Plants are expensive, residue gas is still flared, and uneconomical to operate when gas volume declines”). Since the operator has to provide no information for that section and the form itself rejects the alternatives, it appears highly unlikely that the requirement to file a Gas Capture Plan has incentivized any operator to consider, let alone seriously evaluate the feasibility and economic implications of, implementing any of the listed alternatives.

Reducing venting and flaring reduces resource waste and air pollution, and where the gas is captured, increases the production of gas resources and the resulting revenues without additional land disturbance. Thus, policies to reduce venting and flaring should be regarded as win-win-win, and there should be no conflicting priorities among these agencies.

Are there existing regulations related to methane that do not address the intended purpose? Identify any unintended barriers to methane reductions/capture that may hinder proposed processes.

Other considerations or comments (e.g. particular design or technological challenges/opportunities, co-benefits, non-air environmental impacts, etc.):

All policies to reduce venting and flaring reduce not only methane, but also VOCs, NOx and toxic air pollutants, producing improved air quality and health benefits for nearby residents.

#### **SHUTTING IN A WELL OR CURTAILING PRODUCTION**

In general, the New Mexico Oil and Gas Act requires the New Mexico Oil Conservation Commission (NMOCC) and New Mexico Oil Conservation Division (NMOCD) to prohibit production voluntarily to address various conditions including poor price environments and downstream upset conditions. and oil and gas handling practices which constitute or result in waste. NMSA 1978, § 70-2-2. The concept of “waste” has been statutorily defined by the New Mexico Legislature to include both underground waste and surface waste. NMSA 1978, § 70-2-3. Underground waste can consist of any practice that reduces or tends to reduce the total quantity of crude oil or natural gas ultimately recovered from a reservoir, e.g. shutting in a well; whereas surface waste consists of unnecessary or excessive surface loss or destruction of oil or gas, without beneficial use. Thus, NMOCC and NMOCD are required by statute to encourage the optimum recovery of oil and gas resources. The federal government and other oil and gas producing states similarly prohibit the creation of waste. *See e.g.*, 30 U.S.C. § 187; 30 U.S.C. § 225; WYO. STAT. ANN. § 30-5-101.

For the purpose of limiting venting and flaring, “waste” has historically been defined by the federal government and other oil and gas producing jurisdictions as a “preventable loss of [oil or gas] the value of which exceeds the cost of avoidance.” Stephen L. McDonald, Petroleum Conservation in the United States, and Economic Analysis, Johns Hopkins Press, 1971 (Reprinted in 2011 by Resources for the Future) (“Petroleum Conservation Economics”), at 129. NMOCD regulations have likewise allowed flaring in situations where “the flaring or venting casinghead gas appears reasonably necessary to protect correlative rights, prevent waste or prevent undue hardships” on the operator. 19.15.18.12.B NMAC. Indeed, flare may provide environmental benefits in certain situations. The New Mexico Environment Department (NMED) has approved

<sup>132</sup> See Gas Capture Plan (ADD LINK TO FORM).



flaring in a variety of situations, and the federal government specifically requires flaring in certain situations. See NMED, Air Quality Bureau General Construction Permits; 43 C.F.R. § 3179.6(b).

Shutting-in production to avoid flaring would lead to unmanageable gathering system swings. If all operators in the area were to shut-in wells throughout the day to avoid flaring, there would be unmanageable swings on the wells and the pipeline system, with high frequency starts/stops, as all operators shut-in at high pressures, resume production when pressure drops, and immediately back up the pipeline system again when flowing, which again causes all wells in the area to shut-in. This can also lead to frequent trips at the compressor station and additional delays as equipment must be restarted, often manually.

Shutting-in production would affect necessary and routine maintenance operations like pigging. Pigging is the process of launching a malleable or hard plug (called a pig) from an upstream location and allowing pressure to carry the pig to a receiver. The pig sweeps liquid forward and thus reduces liquid in the line. As the pig and liquid front sweep through the system, pressure increases upstream and can thus reduce sales volumes. In areas with rich produced gas (high liquid content), the gas gatherers must frequently pig their lines to manage liquid buildup. Shutting in wells can cause the pig to become stuck because the pressure is too low to drive the pig. Once a pig is stuck, flaring is exacerbated as it is infeasible to override the shut-in valve when pigging occurs with high frequency.

Shutting-in production can also lead to lease default and/or lease maintenance issues. This could ultimately lead to suspended production and the royalties on that production, and wells being shut in (or otherwise cease producing) beyond the term of the lease or leases in question.

Frequent shut-ins can kill a flowing well and lead to premature installation of artificial lift at a significant cost. When a new well is still naturally flowing, artificial lift is unnecessary. Any shutdown poses a risk of liquid loading up in the wellbore and liquid head is greater than available pressure. This is known as “killing” the well. To resume production, a swabbing rig is brought on site to unload the liquids or some means of artificial lift (temporary or permanent) is utilized. If the well has been naturally flowing for a few months, an extended shut-in may require the well be prematurely put on a continuous artificial lift at a cost (gas lift, electric submersible pump, rod pump, etc.). Frequent swabbing increases venting of methane or premature installation of artificial lift again adversely affect well economics. Given lead times and rig schedules, it may take several months to install artificial lift, during which time the well is not producing and may be shut-in or otherwise cease producing.

Shut-in events have the potential to impact the productivity of low permeability hydraulically fractured reservoirs due to various reservoir and mechanical causes. These effects, either individually or combined, have often resulted in a negative effect on productivity of the well and/or an increase in operating costs. It has been well documented in the technical literature that several mechanistic effects associated with shut-in of hydraulically fractured wells can impact productivity and ultimate oil recovery<sup>133</sup>. The damage from repeat shut ins is irreversible and permanent, and is likely to lead to lower ultimate recovery and increased waste. Examples of mechanistic effects include:

---

<sup>133</sup>S. A. Holditch and D. M. Blakeley, “Flow Characteristics of Hydraulic Fracture Proppants Subjected to Repeated Production Cycles,” SPE 19091, 1992.

M. R. Besler, “Bakken Completion Challenges,” The Bakken Shale Forum, University of North Dakota Energy and Environmental Research Center, Grand Forks, ND USA. November 6, 2007.

G. R. Coulter, and R. D. Wells, “The Advantage of High Proppant Concentration in Fracture Stimulation,” SPE 3298, SPE Journal, June 1972.

J. L. Gidley, G. S. Penny, and R. R. McDaniel, “Effect of Proppant Failure and Fines Migration on Conductivity of Propped Fracture,” SPE 24008, 1995.

J. Terracina, “Effects of Proppant Selection on Shale Fracture Treatments,” JPT Update, May 2011.

- Mechanical stress cycling on the proppant
- Generation of fines
- Potential damage due to fracture fluids
- Need to restore the productivity of the shut-in well through intervention.

### **PERCENT GAS CAPTURE REQUIREMENTS**

Without a robust dataset and a long term coordinated effort including producers, midstream companies and state agency leadership, percent gas capture goals would have no basis in NM. This is why these data improvement changes, as well as better gas capture planning, are noted below as Paths Forward. Informing an appropriate and achievable percent capture goal requires a robust toolkit in a manner that considers anti-trust laws.

- Comprehensive, accurate, consistent and reason based flare volume reports
- Detailed information on current market, pipeline, compression & plant capacity constraints
- Comprehensive overlay of forecasted infrastructure and production data
- Detailed understanding of compression and electrical grid reliability
- Streamlined right-of-way permitting and execution process
- Comprehensive understanding of gas-to-oil ratios (SE NM has 10+ producing zones)
- Incentives for alternative technologies
- Comprehensive gas capture plans that enable best case scenario gas contracts to prevent as much flaring as possible and a hydraulic analysis by my midstream entity, along with the impact of expected volumes from other operators

It is important to note that BLM and North Dakota are the only entities to have attempted to implement a percent capture goal. The BLM's scheme was stayed by a federal district court, thus, the effectiveness and viability was never tested. As explained below and in the case of North Dakota, there are market, rights-of-way, political and other conditions that have impacted the ability for North Dakota to achieve the established goals.

In the fall of 2013, the North Dakota Petroleum Council formed the Flaring Task Force. Members of the task force sought to pool the knowledge and experience of producers and midstream companies operating in the Bakken to identify solutions to better optimize the resource at the wellhead and increase and improve existing infrastructure to transport gas for processing elsewhere. The Task Force's goals were to offer balanced, effective solutions for policy makers and regulators. The Flaring Task Force addressed the North Dakota Industry Commission on January 29, 2014, which resulted in the first of its kind percent gas capture requirements.

In North Dakota, the Pipeline Authority provides monthly updates to the public. The updates provide an overlay of associated gas forecasts and infrastructure buildout as well as month to month maps of where flaring is occurring. NDPA's purpose is to diversify and expand the North Dakota economy by facilitating development of pipeline facilities to support the production, transportation, and utilization of North Dakota energy-related commodities. NDPA is a non-policy, non-regulatory entity.

<https://northdakotapipelines.com/directors-cut/>

---

S. Agrawal and M. Sharma, "Impact of liquid Loading in Hydraulic Fracture on Well Productivity," SPE 163837, 2013.

J. W. Crafton, and S. L. Noe, "Impact of Delays and Shut-Ins on Well Productivity," SPE 165705, 2013.

## Solving the Flaring Challenge

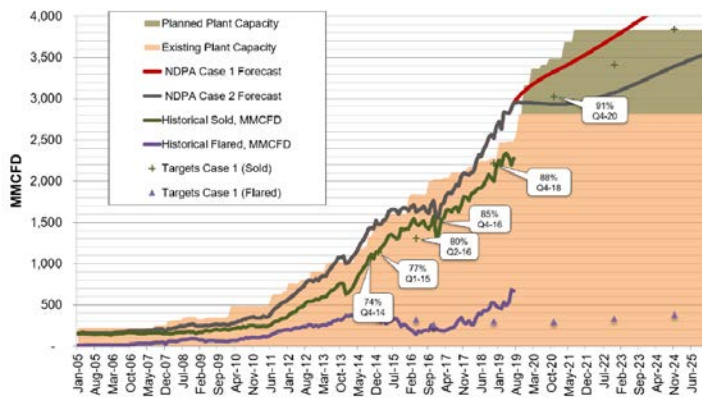

JJ Kringstad - North Dakota Pipeline Authority

14

Despite efforts described above, ND is still struggling with meeting gas capture limits. In addition, the depressed market inhibited investment in gas processing and transmission assets. Also exacerbating the issue were 2 rights-of-way issues that amounted to a total of 6% of the total gas flared in ND. Industry reactivated the Task Force with 6 separate committees to assess infrastructure buildout, right-of-way and tribal regulatory challenges, H<sub>2</sub>S contamination, remote capture technologies, new operator engagement, and reworking of the gas capture plan requirements. In the fall of 2015, the Flaring Taskforce provided the updated information to the North Dakota Industrial Commission in the fall of 2015, which resulted in the adjustment of the gas capture goals.

Note that the near-absence of any sanctions or penalties for companies that fail to meet the targets, as discussed above, means that the regulation as implemented provides little incentive for companies to expend resources on compliance. Given that compliance is likely to involve some cost, while noncompliance involves little to no cost, a profit-maximizing entity will be acting rationally in failing to comply. NDIC guidance updates indicate their enforcement mechanism is production curtailment but it has only issued an enforcement action a handful of times despite clear violations. Data for voluntary curtailment is not available.

## 5. VENTING AND FLARING - PATH FORWARD<sup>134</sup>

	OPTIONS	DESCRIPTION AND LINK TO INFORMATION IF AVAILABLE. PLEASE LIST THE BENEFIT THAT COULD BE ACHIEVED THROUGH THIS OPTION AND ANY DRAWBACKS OR CHALLENGES TO IMPLEMENTATION	EFFECTIVENESS OF COST NOW (choose one)	REPORTING, MONITORING AND RECORDING OPTIONS, INCLUDING REMOTE DATA COLLECTION	IS THIS OPTION HELPFUL IN THE SAN JUAN BASIN, PERMIAN BASIN OR BOTH
6.1	More detailed reporting on C-115 form (production report)	Developing more consistency across the state in how flared gas volumes are reported (i.e., measurement v. estimation, source of gas reported, requirement to report) will benefit the state as it establishes future rules, requirements, and reduction targets.	HIGHLY COST EFFECTIVE	The reporting requirement should include a protocol that establishes consistent reporting, specifies types of flaring that should be reported and an approved standard for measuring flared gas (or accepted methodology for estimating and verifying flared gas volumes).	
COMMENT: A. Clarify scope of C-115 – This is currently a production report and it would be helpful to keep that scope rather than adding additional scope (tank vapors, etc.) to this specific report. A separate report for NMED would be appropriate for an emissions inventory.			SUGGESTION TO MAKE THIS OPTION MORE WORKABLE:		
6.2	Establishing requirement to submit Gas Capture Plan with APD through rulemaking	Making it a requirement to submit a Gas Capture Plan through rulemaking makes the submittal of the Gas Capture plan enforceable	HIGHLY COST EFFECTIVE	Submittal of Gas Capture Plan	
COMMENT:			SUGGESTION TO MAKE THIS OPTION MORE WORKABLE:		

<sup>134</sup> The format of the Path Forward table evolved over the course of the meetings as the group tried to identify the best method for capturing the most useful information. As a result, there is some variation in the table headers from topic to topic in the final consolidated report.

6.3	Operators do not vent when gas can be flared instead.	See BLM rules. Substantial methane reductions. Consistent with best safety practices, which already strongly discourage venting methane.	Operators do not vent when gas can be flared instead.	See BLM rules. Substantial methane reductions. Consistent with best safety practices, which already strongly discourage venting methane.	
COMMENT:			SUGGESTION TO MAKE THIS OPTION MORE WORKABLE:		
6.4	Operators engage with midstream in more active development planning [Addressed in MAP infrastructure planning report]				
COMMENT:			SUGGESTION TO MAKE THIS OPTION MORE WORKABLE:		
6.5	Current regulation (19.15.18.12A NMAC) prohibits an operator from flaring or venting casinghead gas produced from a well after 60 days of the well's completion. Provided the exception process is better defined and includes a notice provision, a reduction to 30 days from the 60 days currently authorized is proposed.	Prevention/reduction of waste Consistent with BLM requirement	HIGHLY COST EFFECTIVE	To be reported as a non-transported volume on C-115	
COMMENT:			SUGGESTION TO MAKE THIS OPTION MORE WORKABLE:		
6.6	Auto igniters for new flares	Ensures pilots are lit, minimizing venting from unlit flares	HIGHLY COST EFFECTIVE		
COMMENT:			SUGGESTION TO MAKE THIS OPTION MORE WORKABLE:		
6.7	Ensure that all venting and flaring from oil and gas production and gathering upstream of the processing plant is reported on a monthly basis, consistent with clear standards, and made publicly available online. Clarify that C-115 (or another appropriate form) should include venting and flaring that occurs:	Developing more consistency across the state in how flared gas volumes are reported (i.e., measurement v. estimation, source of gas reported, requirement to report) will reduce ambiguity and confusion for industry on what they are required to report, enhance data quality, help the state to develop the most efficient and effective future rules, requirements, and reduction targets, and benefit the public in better understanding how NM's natural resources are	HIGHLY COST EFFECTIVE	The reporting requirement should include a protocol that establishes consistent reporting, specifies types of flaring that should be reported and an approved standard for measuring flared gas (or accepted	

	<p>--due to lack of connection with a pipeline</p> <p>-- during completions/recompletions, including during initial flowback;</p> <p>-- in response to upsets, disruptions, capacity constraints anywhere in the system;</p> <p>--in the course of maintenance activities;</p> <p>--from operation of pneumatics, tank vapors, and flaring of such vapors (Note that BLM considers these volumes unavoidable lost or beneficial use. Also, low pressure flaring is out of scope for this report.);</p> <p>--each of operator's temporarily abandoned well, if venting occurs; and</p> <p>-- any other sources of venting and flaring that can be measured or estimated.</p> <p>--Adopt third-party audit or verification program to ensure that operators are complying with reporting requirements (given past high levels of non-compliance and also compliance with the exception criteria).</p>	<p>being used, conserved, or wasted. See Norway (monthly reporting and public reporting)</p>		<p>methodology for estimating and verifying flared gas volumes). Reports should be certified by appropriate officers of reporting company. Aggregated reports should be compared to satellite data and any discrepancies investigated promptly. Third-party audit or verification program to ensure that operators are complying with reporting requirements (given past high levels of non-compliance). Regulatory consequences must be strong for inaccurate reporting. Reports should be public.</p>	
	COMMENT:		SUGGESTION TO MAKE THIS OPTION MORE WORKABLE:		
6.8	<p>Include, in reporting specifications, standards for measurement and/or highly reliable estimation approaches based on measurement of other known variables, such as oil production volumes and frequent</p>	<p>Providing industry clear guidance for reporting estimation and measurement methodologies will reduce ambiguity and confusion for industry, enhance data quality, allow the state to better target prevention efforts, and enhance public understanding.</p>	<p>HIGHLY COST EFFECTIVE</p>		

	(e.g., monthly) measurements of gas-to-oil ratio.				
COMMENT:		SUGGESTION TO MAKE THIS OPTION MORE WORKABLE:			
6.9	Require use of reliable tools for measuring or estimating flared volumes; require regulatory oversight of purchase and calibration of measurement tools (It is important to note that OCD has no authority over purchasing of equipment and BLM requires use of approved equipment under the new measurement rules. )	Norway requires that a regulator is present from the moment the operator places an order to buy instruments (design phase) to calibration of the instruments and tools to decommissioning.	HIGH COST EFFECTIVENESS	Robust recordkeeping and reporting of flared volumes necessary to ensure compliance.	
COMMENT:		SUGGESTION TO MAKE THIS OPTION MORE WORKABLE:			
6.10	Establish electronic reporting system for all sources of venting and flaring (e.g., including C-129s and C-141s) upstream of processing plants and make results publicly available online. Note that C-129s are submitted by operators as a “just in case” and volumes are estimated. C-141s are after-the-fact and volumes reported as a non-transported disposition code “L” for lost. Therefore, any actual volumes are reported on C-115s. See “enhanced reporting and measurement protocols.”	Reporting all venting and flaring information electronically would reduce administrative burdens for industry and the state, greatly facilitate data analysis, and make results accessible to the public	HIGHLY COST EFFECTIVE		
COMMENT:		SUGGESTION TO MAKE THIS OPTION MORE WORKABLE:			
6.11	Condition grant of APD on submission of adequate Gas Capture Plan with APD.	Conditioning grant of APD on submission of an adequate Gas Capture Plan provides operators a strong incentive to submit adequate gas capture plans and makes the submittal of the Gas Capture plan readily enforceable with minimal state effort.	HIGHLY COST EFFECTIVE	Submittal of Gas Capture Plan	
COMMENT:		SUGGESTION TO MAKE THIS OPTION MORE WORKABLE:			

6.12	<p>Specify gas capture plan elements to include (items highlighted below are already part of the NM Gas Capture Plan):</p> <ul style="list-style-type: none"> <li>--well location; expected drilling, completion, and first production date; expected volumes and pressures;</li> <li>--from multiple wells for the above if operator is planning multiple wells in same area within relevant timeframe;</li> <li>--information about the operator's other current production, and venting and flaring, in the vicinity of the proposed well;</li> <li>--identification of intended gathering system and processing facility for gas production, including pipeline size, pressure, and available capacity now and for the period over which the well is projected to produce, and plan for additional compression if needed;</li> <li>--showing/certification that the operator has communicated projected gas volumes and timing for all operations in the vicinity of the destination pipeline to the midstream company, including current venting and flaring;</li> <li>--showing/certification that midstream company projects there will be available capacity to accept the projected gas production from the specified well;</li> <li>--if pipeline capacity not projected to be available, specific plan for alternative gas use/disposal, with demonstration that the operator has</li> </ul>	<p>Compliance with comprehensive GCP requirements would greatly improve information available to midstream operators to plan their systems to align with expected gas production in a timely fashion. It would also document for OCD that the producer has obtained transportation and processing capacity for wells that are drilled at the time they go into production. However, the data supplied during this phase of planning is a snapshot in time and may or may not be drilled. See ND, BLM 2016 rules. Expanding the elements required for an adequate GCP would ensure that the operator produces a plan that results in capturing (or disposing through a means other than venting / flaring) the projected volumes of gas over the projected lifetime of the well. For operators seeking APDs for wells without a drilling schedule or sufficient information to forecast production, OCD should consider establishing a process for conditional APD approvals with requirements to update the GCP when required information is available before final drilling approval is granted.</p>	HIGHLY COST EFFECTIVE		
------	---	---	-----------------------	--	--



	<p>the ability to implement such plan (e.g., if plan to reinject gas, show permit applications submitted; if plan to generate for grid, show communications with grid operator, etc.)</p> <p>-measures to prevent waste over the life of the well, including additional compression and operator elected proper plugging and abandonment to avoid the rare instance of orphan well venting scenarios.</p>				
	COMMENT:		SUGGESTION TO MAKE THIS OPTION MORE WORKABLE:		
6.13	<p>Define “undue hardships” (e.g. maintenance, emergencies) as per 19.15.18.12.B NMAC while maintaining the ability to apply for an exception.</p>	<p>Provides regulatory certainty on flaring events that establishes a basis for NMOCD to make an inform decision to grant or deny an exception.  <u>See: “Describe how the equipment or process is used:” section starting on page 3 that describes “When Flaring is Necessary”.</u></p> <p>Consistent with some NMED exceptions.</p> <p>Note that other recommendations below would move the state away from case-by-case exemptions to reduce administrative burden on the state and industry and boost overall effectiveness of limits on venting and flaring.</p>	HIGHLY COST EFFECTIVE	Documentation and notification of events, record keeping limits	
	COMMENT:		SUGGESTION TO MAKE THIS OPTION MORE WORKABLE:		

6.14	Prohibit operators from venting whenever gas can be flared instead; i.e., only allow venting when flaring is not possible as a technical matter or where flaring is prohibited due, e.g., to wildfire risk. Note that both the BLM and OCD have rules requiring flaring rather than venting. See page 162 for BLM rule §3179.6(b) and page 163 for NMOCD rule 19.15.18.12.F.	See BLM rules. Substantial methane reductions. Consistent with best safety practices, which already strongly discourage venting methane.	HIGH COST EFFECTIVENESS	Report all venting events, volumes and circumstances allowing (e.g., liquids recovery operation). Continue remote sensing/satellites to track area-wide decreases in methane emissions.	
COMMENT:			SUGGESTION TO MAKE THIS OPTION MORE WORKABLE:		
6.15	Adopt performance standard for new and existing flares to ensure high destruction removal efficiency (minimum 98%) and continuous burning pilots.	Minimizes excess emissions due to incomplete combustion and improperly operating flares. See CO, WY, ND.	HIGH COST EFFECTIVENESS	Require operators provide manufacturer specification for flares demonstrating compliance with DRE and require operators inspect flares routinely to ensure proper operation	
COMMENT:			SUGGESTION TO MAKE THIS OPTION MORE WORKABLE:		
6.16	Set overall limit (with no exceptions for specific activities/circumstances) on the gas flared by each operator. Limit could take the form of a minimum percentage and/or volume of total gas production from the operator in the State that must be captured. If apply sufficiently stringent overall percentage limits, could potentially allow for a limited volume of flaring/well on average over all of an operator's wells (note that C-115s are required to be	See ND and 2016 BLM rules, and specifically 2016 BLM rule set volume of allowed flaring rather than case-by-case exemptions. Allows market to optimize approach rather than requiring the state to select or mandate use of particular technologies or practices. For example, had operators been limited to flaring no more than 1% of their reported associated gas in 2018, this measure would have avoided the waste of 77% or 28 bcf of gas in that year, as well as the associated volumes of CO <sub>2</sub> , NO <sub>x</sub> and other pollutants. <sup>135</sup> This approach still recognizes that avoiding flaring in some circumstances, such as emergencies, may	HIGH COST EFFECTIVENESS	Report all flaring volumes, without exceptions. Robust recordkeeping and reporting of flared volumes necessary to ensure compliance.	

<sup>135</sup> Calculation by Clean Air Task Force based on C-115 data.

	submitted the 15 <sup>th</sup> day of the second month following the month of production, therefore, an average will not be based on most current volumes) that may be deducted from the capture percentage compliance calculation (in lieu of requiring burdensome case-by-case requests and approvals for emergencies, maintenance, and force-majeure events etc.), and ratchet that deductible volume down over time, giving operators an incentive and opportunity to fine-tune operations to reduce such events.	not be cost-effective or even possible, but it does so without requiring industry and OCD to engage in the burdensome process of case-by-case requests for exemptions, reviews, and determinations.			
	COMMENT:		SUGGESTION TO MAKE THIS OPTION MORE WORKABLE:		
6.17	Establish automatic consequences for failure to meet capture percentage standards. E.g., set a meaningful fee per mcf gas flared/vented in contravention of applicable capture standard, due upon notice of exceedance; and/or require operator to be in compliance with capture percentage standard as a pre-condition for issuance of any new APD for such operator. Ensure flaring policy is enforceable and penalties sufficient to outweigh financial incentives to flare rather than capture.	Effectiveness of ND rules has been severely undermined by lack of enforcement or even consequences for operators that consistently fail to achieve capture standards. OCD has very limited enforcement resources. Establishing automatic penalties would provide a clear, consistent incentive for operators and minimize implementation burden on OCD. Limiting production as a penalty for failing to meet capture standards may be less effective than (meaningful) financial penalties, as both the state and the industry aim to increase, not reduce, production.	HIGH COST EFFECTIVENESS	Robust recordkeeping and reporting of flared volumes necessary to ensure compliance.	
	COMMENT:		SUGGESTION TO MAKE THIS OPTION MORE WORKABLE:		
6.18	Assess severance tax and royalties on all gas produced rather than only on gas produced or sold	May require legislative fix to change tax and royalty policy.	HIGH COST EFFECTIVENESS	Calculate additional revenues from alternative tax and royalty levels.	

	COMMENT:		SUGGESTION TO MAKE THIS OPTION MORE WORKABLE:		
6.19	Prohibit flaring unless permitted by OCD. Only permit flaring required for specific delineated circumstances (e.g., safety emergencies, unplanned infrastructure maintenance, upset conditions, etc.). Permit would specify volume and/or time limit. Consider exempting defined de minimis amount of flaring from permit requirement. Monitor to avoid repeat exemptions and long-term flaring.	See Alaska (clear prohibition on flaring other than in narrow circumstances); Norway (extends capture requirements to all phases of production) Ensures any allowable flaring, in particular during emergencies or for safety, is kept to a minimum.	HIGH COST EFFECTIVENESS	Robust recordkeeping and reporting of flared volumes necessary to ensure compliance. System to flag repeat applications to flare.	
	COMMENT:		SUGGESTION TO MAKE THIS OPTION MORE WORKABLE:		
6.20	Create permitting options for some of the more recent reinjection solutions that have been presented to NMOCD.	New EOR projects by injecting produced gas may reduce flaring by not crowding pipeline capacity.		UIC permit application type and requirements.	
	COMMENT:		SUGGESTION TO MAKE THIS OPTION MORE WORKABLE:		
6.21	Approve alternative technology by more streamlined NMED permitting process.	Once alternative technology is proven, permitting process should be expedited to accommodate temporary flaring events.	HIGH COST EFFECTIVENESS	Document proven alternative technologies and make available via NMED website.	
	COMMENT:		SUGGESTION TO MAKE THIS OPTION MORE WORKABLE:		
6.22	Clarify the definition of waste in venting/flaring regardless of whether or not it is an authorized exemption.	Identify/define "waste" for the purposes of royalty reporting.	HIGHLY COST EFFECTIVE	Line by line C-115 reporting	
	COMMENT A. Evaluate compatibility with existing statutes/regulations.		SUGGESTION TO MAKE THIS OPTION MORE WORKABLE:		
6.23	Ability to amend C-115 by line to ensure accurate reporting/ability to amend reports vs. requiring a company's statewide C-115 production to be re-submitted.	The benefit would be that agencies could more readily assess line by line modifications and would also minimize production inaccuracies for both the company and the agencies.			
	COMMENT:		SUGGESTION TO MAKE THIS OPTION MORE WORKABLE:		

DRAFT

# SECTION 7, WORKOVERS/LIQUIDS UNLOADING

Discussion for MAP members on September 12, 2019

---

NOTE: The focus of this report is processes, and the associated equipment, directly related to the release or capture of methane gas. We are not requesting information on processes/equipment that are not related to the release or capture of methane gas.

## 1. DESCRIPTION OF PROCESS AND EQUIPMENT

Provide a description of the processes and/or equipment used in oil and/or gas extraction for this topic. Note that this report template will be used for all topics of the MAP review and, thus, not all questions or information may be relevant for each topic. If information is not relevant, indicate N/A. Note any differences expected for differing well types, industry sector, or basin location.

Technical description of the process or equipment:

### Manual Liquid Unloading:

Managing wellbore liquid build-up in gas wells is fundamental to maintaining production, avoiding early abandonment of wells and maximizing resource recovery. Wells and reservoirs follow a continuum of flow regimes in their economic life as the reservoir depletes, production declines, wellbore (tubing) velocity goes down, and liquid loading begins to occur in the wellbore. Liquid loading begins when the velocity up the production string is not sufficient to lift liquids up to the surface at a pressure that will allow production to overcome the surface equipment and out of the wellbore. While pressure is a factor, it is generally a lack of velocity, which causes liquids to accumulate in the wellbore (i.e., “to load/load up”). Gas well unloading is a complex field of science and engineering where a large number of different technologies, tools and practices must be matched to an individual well’s characteristics at each stage of its lifecycle to most efficiently manage liquids and maintain economic viability of the well. No single technique will be adequate or appropriate across the full lifecycle of a well.

As a well moves through its lifecycle, the appropriate approach to managing liquids changes. New wells typically have sufficient production rates and flowing velocity so that liquids loading is not an issue. As the portion of the reservoir accessed by a well depletes, the production rate and velocity declines and eventually a point is reached where liquids loading begins to be an issue. The time at which liquids loading occurs is dependent on the reservoir characteristics and varies from well to well. At the onset of liquids unloading, techniques that rely on the reservoir energy are typically used. These include:

- **Intermitting**: Shutting in a well for a period of time to allow the reservoir to “refill” the pressure and volume “void” in the near-wellbore reservoir so that when the well is restarted the production rate and velocity are higher and the well can “unload” liquids through the normal production route to sales;
- **Velocity strings**: Installing a smaller diameter tubing string in the well that increases the flow velocity at a given production rate sufficiently to drag liquids up the wellbore and prevent liquid loading;
- **Surfactants and foaming agents**: Introducing surfactants and foaming agents to the bottom of a well (various techniques are used) creating foam with lower specific gravity which enables liquids to be carried up the wellbore at lower velocities.

These techniques can be used individually or in combination to manage wellbore liquids and maintain production.

Eventually a well will reach a point where the reservoir energy is not sufficient to remove the liquids from the well and adding energy to the well is necessary to continue production. Common approaches are to install artificial lift. Two common methods are:

- Installing a plunger lift system that changes the dynamic for removing liquids from velocity to differential pressure between the bottom-hole and the surface/gas collection line; or
- Installing wellhead compression that lowers the surface back-pressure on a well, increases production rate and flowing velocity, and increases the differential pressure between the reservoir and the collection/sales line.

There are a number of different pump types and gas lift systems, each more effective in some respects than others. Installation of a system to add energy to a well is an economic decision based on whether the continuing production will be sufficient to support the costs of installing and operating a pump or gas lift system.

There are some cases where the need to create additional differential pressure is necessary to manually unload accumulated liquids. These cases include onsite or downstream equipment downtime in the gas gathering system.

One item of clarification is that deliquification, liquid unloading and venting are not synonymous terms. Liquids can and are routinely removed from gas wells without venting.

**Workovers:**

Some wells may need to be re-stimulated in a previously completed formation or in a new reservoir in the same wellbore. These operations are called recompletions. Additionally, some wells will require supplementary maintenance to maintain production or minimize the decline in production and are referred to as workovers. Typical workovers include rod, tubing and casing repairs, siphon string or artificial lift installation, paraffin removal, and pump repairs.

Both recompletions and workovers differ from completions in that they are performed on wells that have previously been completed and have produced some reservoir fluids (water, oil, and/or natural gas). These wells will have to be prepared before recompletion or workover operations can begin. If the well is still producing and/or has pressure, the well will need to be blown down before it is safe to remove the tubing head and install the blowout preventers (BOP's). The well pressure can be decreased by opening the casing to the sales line or the suction of a wellsite compressor. In many cases the fluids in the wellbore will build up to the point the well dies, this is referring to the instance where the hydrostatic pressure of the accumulated fluids is equal to the reservoir pressure. In some cases, it will be necessary to pump water or other fluids in the wellbore to kill the well. As a safety precaution, after the BOP's are installed the well is usually vented to atmosphere via a tank.

In the case of a recompletion, after the well is prepared (well blown down, BOP's installed, and the tubing removed) the stimulation and flow back will be the same as the issues that were presented in the COMPLETIONS/STIMULATIONS Report. A recompletion would be a stimulation of an existing well, in a different horizon, that has already been completed. The preparation of the well for a recompletion is the source covered in this Workovers/Liquids Unloading Report. The preparation of the well, as mentioned above is the process in which the pressure on the wellbore is reduced to atmospheric pressure by venting the well through an atmospheric storage tank. The pressure is relieved to atmosphere to ensure the well can safely be worked on (workover) or recompleted.

Workovers are usually short duration projects that only last a few days or weeks at the most. After the well is prepared (well blown down and the BOP's installed) the workover operations can begin. For the safety of the rig crew, the well is usually allowed to vent to atmosphere via a tank for the duration of the workover. Since these operations are usually performed during daylight hours, the well is shut in or returned to the sales line at the end of the day.

**Provide the segment(s) of the industry that the equipment or process is found:**

This process is found in the oil and gas production segment of the industry.



Describe how the equipment or process is used:

The production from the wellbore (tubing and/or casing) is routed to an atmospheric tank to create the differential pressure necessary to manually unload the liquids accumulated in the wellbore or to make the wellbore safe to perform downhole maintenance.

Provide the common process configurations that use this equipment or process:

The liquids unloading process applies primarily to gas wells. The workover operations apply both to oil and gas wells.

What is the distribution of the equipment or process across business segments?

This process primarily relates to the onshore oil and gas production sector.

How has this equipment or process evolved over time?

The technology for gas well deliquification has advanced over time and operators have adopted many wellbore best management practices that have minimized the amount of manual liquids unloading events necessary to keep well production optimized. Advanced planning to reduce the wells pressure prior to blowing the well down have resulted in reduced emissions.

## 2. INFORMATION ON EQUIPMENT OR PROCESS COSTS, SOURCES OF METHANE EMISSIONS, AND REDUCTION OR CONTROL OPTIONS

Identify the capital and operating costs for the equipment or the process. Identify how methane is emitted or could be leaked into the air. Please **prioritize** the list to identify first the largest source of methane from the process or equipment and where there is **potential** for the greatest reduction of methane emissions. Note any differences expected for differing well types, industry sector, or basin location.

### Sources of Methane:

Provide an overview of the sources of methane from this equipment or process:

The source of methane emissions for liquids unloading and workover operations is the venting of a well to an atmospheric tank.<sup>136</sup>

---

<sup>136</sup> Leaks, upsets and other fugitive emissions are addressed in the leak detection and repair report.

### New Wells:

New wells typically have sufficient production rates and flowing velocity so that liquids loading is not an issue. New wells normally do not require downhole maintenance but if a workover is necessary the process is the same for new and existing wells.

### Existing Wells:

The methane emissions for workovers/liquids unloading operations comes from the venting of the well through atmospheric tanks to unload liquids or make the wellbore safe to preform downhole maintenance.

### How are the emissions calculated for this equipment or process?

The formulas included below reflect the calculation methodology for estimating emissions from manual liquids unloading events under the EPA Greenhouse Gas Reporting Program (GHGRP). Note that emissions from workovers are combined with completions in the GHGRP program. This calculation methodology contains 3 layers of conservatism in estimating emissions that result in a gross overestimation of emissions. First, the first term of the calculation methodology assumes the full wellbore contains gas only, which does not account for the space occupied by liquid. This assumption over estimates the volume of gas in the column and, therefore, the amount of gas vented. Also, if the tubing or casing were occupied by gas only, a manual liquids unload would not be required. Second, the GHGRP calculation methodology also assumes these activities are no more than 1 hour and 0.5 hour, respectively. After this timeframe, the method assumes the well is venting at the production rate, which leads to another layer of overestimation of emissions. Third, during a manual liquids unloading activity, the valve that allows for flow to the tank may be open for period of time with no liquid/gas movement, therefore, the method assumes flow when there may not be.

Blowdown volumes for wells without plungers (assumes casing)

$$\left( \left( \left\{ \begin{array}{l} \text{Physical Volume of Casing} \\ \text{Being Blown Down} \\ [ft^3] \end{array} \right\} \times \left\{ \begin{array}{l} \text{Convert to Atmospheric} \\ \text{Pressure} \end{array} \right\} \right) + \left( \left\{ \begin{array}{l} \text{Avg Gas} \\ \text{Flowrate} \\ \left[ \frac{scf}{hr} \right] \end{array} \right\} \times \left( \begin{array}{l} \text{Blowdown} \\ \text{Duration} - 1 \end{array} \right) \times \left( \begin{array}{l} 1 \text{ [if duration longer than 1 hr]} \\ \text{or} \\ 0 \text{ [if duration shorter than 1 hr]} \end{array} \right) \right) \right)$$

Blowdown volumes for wells with plungers (assumes tubing)

$$\left( \left( \left\{ \begin{array}{l} \text{Physical Volume of Tubing} \\ \text{Being Blown Down} \\ [ft^3] \end{array} \right\} \times \left\{ \begin{array}{l} \text{Convert to Atmospheric} \\ \text{Pressure} \end{array} \right\} \right) + \left( \left\{ \begin{array}{l} \text{Avg Gas} \\ \text{Flowrate} \\ \left[ \frac{scf}{hr} \right] \end{array} \right\} \times \left( \begin{array}{l} \text{Blowdown} \\ \text{Duration} - 0.5 \end{array} \right) \times \left( \begin{array}{l} 1 \text{ [if duration longer than 0.5 hr]} \\ \text{or} \\ 0 \text{ [if duration shorter than 0.5 hr]} \end{array} \right) \right) \right)$$

GHGRP:

(f)**Well venting for liquids unloadings.** Calculate annual volumetric natural gas emissions from well venting for liquids unloading using one of the calculation methods described in paragraphs (f)(1), (2), or (3) of this section. Calculate annual CH<sub>4</sub> and CO<sub>2</sub> volumetric and mass emissions using the method described in paragraph (f)(4) of this section.

**(1)Calculation Method 1.** Calculate emissions from wells with plunger lifts and wells without plunger lifts separately. For at least one well of each unique well tubing diameter group and pressure group combination in each sub-basin category (see § 98.238 for the definitions of tubing diameter group, pressure group, and sub-basin category), where gas wells are vented to the atmosphere to expel liquids accumulated in the tubing, install a recording flow meter on the vent line used to vent gas from the well (*e.g.*, on the vent line off the wellhead separator or atmospheric storage tank) according to methods set forth in § 98.234(b). Calculate the total emissions from well venting to the atmosphere for liquids unloading using Equation W-7A of this section. For any tubing diameter group and pressure group combination in a sub-basin where liquids unloading occurs both with and without plunger lifts, Equation W-7A will be used twice, once for wells with plunger lifts and once for wells without plunger lifts.

$$E_a = FR \sum_{p=1}^h T_p \quad (\text{Eq. W-7A}) \quad E_a = FR \sum_{p=1}^h T_p \quad (\text{Eq. W-7A})$$

Where:

$E_a$  = Annual natural gas emissions for all wells of the same tubing diameter group and pressure group combination in a sub-basin at actual conditions,  $a$ , in cubic feet. Calculate emission from wells with plunger lifts and wells without plunger lifts separately.

$h$  = Total number of wells of the same tubing diameter group and pressure group combination in a sub-basin either with or without plunger lifts.

$p$  = Wells 1 through  $h$  of the same tubing diameter group and pressure group combination in a sub-basin.

$T_p$  = Cumulative amount of time in hours of venting for each well,  $p$ , of the same tubing diameter group and pressure group combination in a sub-basin during the year. If the available venting data do not contain a record of the date of the venting events and data are not available to provide the venting hours for the specific time period of January 1 to December 31, you may calculate an annualized vent time,  $T_p$ , using Equation W-7B of this section.

$FR$  = Average flow rate in cubic feet per hour for all measured wells of the same tubing diameter group and pressure group combination in a sub-basin, over the duration of the liquids unloading, under actual conditions as determined in paragraph (f)(1)(i) of this section.

$$T_p = HR_p MP_p \times D_p \quad (\text{Eq. W-7B}) \quad T_p = HR_p MP_p \times D_p \quad (\text{Eq. W-7B})$$

Where:

HRp = Cumulative amount of time in hours of venting for each well, p, during the monitoring period.

MPP = Time period, in days, of the monitoring period for each well, p. A minimum of 300 days in a calendar year are required. The next period of data collection must start immediately following the end of data collection for the previous reporting year.

Dp = Time period, in days during which the well, p, was in production (365 if the well was in production for the entire year).

(i) Determine the well vent average flow rate ("FR" in Equation W-7A of this section) as specified in paragraphs (f)(1)(i)(A) through (C) of this section for at least one well in a unique well tubing diameter group and pressure group combination in each sub-basin category. Calculate emissions from wells with plunger lifts and wells without plunger lifts separately.

(A) Calculate the average flow rate per hour of venting for each unique tubing diameter group and pressure group combination in each sub-basin category by dividing the recorded total annual flow by the recorded time (in hours) for all measured liquid unloading events with venting to the atmosphere.

(B) Apply the average hourly flow rate calculated under paragraph (f)(1)(i)(A) of this section to all wells in the same pressure group that have the same tubing diameter group, for the number of hours of venting these wells.

(C) Calculate a new average flow rate every other calendar year starting with the first calendar year of data collection. For a new producing sub-basin category, calculate an average flow rate beginning in the first year of production.

(ii) Calculate natural gas volumetric emissions at standard conditions using calculations in paragraph (t) of this section.

**(2) Calculation Method 2.** Calculate the total emissions for each sub-basin from well venting to the atmosphere for liquids unloading without plunger lift assist using Equation W-8 of this section.

$$E_s = \sum_{p=1}^W \left[ V_p \times \left( (0.37 \times 10^{-3}) \times CD_p^2 \times WD_p \times SP_p \right) + \sum_{q=1}^{V_p} \left( SFR_p \times (HR_{p,q} - 1.0) \times Z_{p,q} \right) \right] \quad (\text{Eq. W-8})$$

Where:

Es = Annual natural gas emissions for each sub-basin at standard conditions, s, in cubic feet per year.

W = Total number of wells with well venting for liquids unloading for each sub-basin.

p = Wells 1 through W with well venting for liquids unloading for each sub-basin.

Vp = Total number of unloading events in the monitoring period per well, p.

$0.37 \times 10^{-3} = \{3.14 (\text{pi})/4\} / \{14.7 * 144\}$  (psia converted to pounds per square feet).

CDp = Casing internal diameter for each well, p, in inches.

WDp = Well depth from either the top of the well or the lowest packer to the bottom of the well, for each well, p, in feet.

SPp = For each well, p, shut-in pressure or surface pressure for wells with tubing production, or casing pressure for each well with no packers, in pounds per square inch absolute (psia). If casing pressure is not available for each well, you may determine the casing pressure by multiplying the tubing pressure of each well with a ratio of casing pressure to tubing pressure from a well in the same sub-basin for which the casing pressure is known. The tubing pressure must be measured during gas flow to a flow-line. The shut-in pressure, surface pressure, or casing pressure must be determined just prior to liquids unloading when the well production is impeded by liquids loading or closed to the flow-line by surface valves.

SFRp = Average flow-line rate of gas for well, p, at standard conditions in cubic feet per hour. Use Equation W-33 of this section to calculate the average flow-line rate at standard conditions.

HRp,q = Hours that each well, p, was left open to the atmosphere during each unloading event, q.

1.0 = Hours for average well to blowdown casing volume at shut-in pressure.

q = Unloading event.

Zp,q = If HRp,q is less than 1.0 then Zp,q is equal to 0. If HRp,q is greater than or equal to 1.0 then Zp,q is equal to 1.

**(3) Calculation Method 3.** Calculate the total emissions for each sub-basin from well venting to the atmosphere for liquids unloading with plunger lift assist using Equation W-9 of this section.

$$E_s = \sum_{p=1}^W \left[ V_p \times \left( (0.37 \times 10^{-3}) \times TD_p^2 \times WD_p \times SP_p \right) + \sum_{q=1}^{V_p} \left( SFR_p \times (HR_{p,q} - 0.5) \times Z_{p,q} \right) \right] \quad (\text{Eq. W-9})$$

Where:

Es = Annual natural gas emissions for each sub-basin at standard conditions, s, in cubic feet per year.

W = Total number of wells with plunger lift assist and well venting for liquids unloading for each sub-basin.

p = Wells 1 through W with well venting for liquids unloading for each sub-basin.

Vp = Total number of unloading events in the monitoring period for each well, p.

$0.37 \times 10^{-3} = \{3.14 (\pi)/4\} / \{14.7 \times 144\}$  (psia converted to pounds per square feet).

TDp = Tubing internal diameter for each well, p, in inches.

WDp = Tubing depth to plunger bumper for each well, p, in feet.

SPp = Flow-line pressure for each well, p, in pounds per square inch absolute (psia), using engineering estimate based on best available data.

SFRp = Average flow-line rate of gas for well, p, at standard conditions in cubic feet per hour. Use Equation W-33 of this section to calculate the average flow-line rate at standard conditions.

HRp,q = Hours that each well, p, was left open to the atmosphere during each unloading event, q.

0.5 = Hours for average well to blowdown tubing volume at flow-line pressure.

q = Unloading event.

Zp,q = If HRp,q is less than 0.5 then Zp,q is equal to 0. If HRp,q is greater than or equal to 0.5 then Zp,q is equal to 1.

**(4)** Calculate CH<sub>4</sub> and CO<sub>2</sub> volumetric and mass emissions from volumetric gas emissions using calculations in paragraphs (u) and (v) of this section.

#### EDF Synthesis:

We did not incorporate liquids unloading data from Allen et al 2014b (\*) because the GHGRP provided more detailed data on event counts and emission rates; the Allen et al estimate of 2012 national emissions from liquids unloading was within a few percent of the GHGRP estimate.

The data suggest that the central estimate of national emissions from unloadings (270 Gg/yr, 95% confidence range of 190–400 Gg) are within a few percent of the emissions estimated in the EPA 2012 Greenhouse Gas National Emission Inventory (released in 2014), with emissions dominated by wells with high frequencies of unloadings. (\*)

(\*) *D. T. Allen, D. W. Sullivan, D. Zavala-Araiza, A. P. Pacsi, M. Harrison, K. Keen, M. P. Fraser, A. Daniel Hill, B. K. Lamb, R. F. Sawyer, J. H. Seinfeld, Methane emissions from process equipment at natural gas production sites in the United States: Liquid unloadings. Environ. Sci. Technol. 49, 641–648 (2015). doi:10.1021/es504016r Medline*

What data is available to quantify emissions/waste for this equipment or process?

<https://www.epa.gov/ghgreporting>

About 85% of the gas wells in the U.S. have production rates low enough to have liquids loading issues, and only about 13% have liquids unloading venting to assist liquid removal in 2012 (gross up of [GHGRP data](#)).

- The frequency and amount of venting to assist liquids unloading is highly skewed, with 10 of the 1991 non-zero datasets reported at the “sub-basin” level (less than 0.5%) datasets accounting for more than 50% of the emissions reported;
- At the facility (basin) and reporter level (251 non-zero data sets) the top 1 (0.4%) accounted for about 37% of the total reported emissions; and
- The top 3 (1.2%) accounted for over 50% of the total methane reported and the top 11 accounted for over 75% of the reported methane emissions.

Methane emissions attributed to LU venting are a fairly small portion of the industry emissions in the GHGI and are trending down

GHGI - 2016 (2018 release) LU Venting
6.1% of Natural Gas Systems E&P CH4
2.0% of Natural Gas Systems CH4
1.6% of Natural Gas + Petroleum Systems CH4

GHGRP, Allen et al 2014b, operator data, etc.

According to the Synthesis\* study, EDF estimates about 21,700 metric tons CH4 from unloading in NM in 2017. Better records of unloading process information would provide better estimates of total emissions. Not surprisingly, the majority of these emissions occur in the San Juan Basin.

According to the EDF Synthesis study\* data, 8.5% of production CH4 emissions are attributable to LU in NM (excluding abnormal process emissions, for consistency with GHGI) vs. 4.9% nationally (or 6.1% per GHGI for the US). This demonstrates a disproportionately high percentage of LU emissions in NM versus the national rate. On tribal lands in NM, Synthesis\* data indicates liquids unloading emissions account for 9.9% of production emissions, even higher than the New Mexico total rate.

\*EDF Synthesis study:

<https://science.sciencemag.org/content/361/6398/186.full?ijkey=42lcrj/vdyvZA&keytype=ref&siteid=sci>

### What are the data gaps in quantifying emissions/waste for this equipment?

Unloading emissions are more often estimated than measured. It is important that operators record process information for better estimates of unloading emissions, such as **number of unloading events and duration of each event**. Operators should also indicate if/how an artificial or plunger lift was utilized.

Further, the Subpart W Greenhouse Gas Reporting Program (GHGRP) requirements only apply to facilities above the emissions threshold. Therefore, not all unloading events are reported under the program.

### **Economic Description of the Process or Equipment:**

What is the per unit cost of the equipment or the costs associated with the process?

The cost for supervision of manual liquid unloading events is dependent upon each unique situation. Additional labor cost of having a lease operator onsite is variable, which make it very difficult to establish a fixed value or even a range.

What are the annualized operating costs for the equipment or costs associated with the process?

N/A

If the equipment or process is powered, what are the costs?

N/A

What are the maintenance and repair costs for existing or new equipment?

N/A

### **Existing Reduction Strategies:**

How has industry reduced emissions/waste from this equipment or process historically?

Operators have developed and employed several wellbore best management practices over the life of the well to avoid the need to perform manual liquids unloads. These best management practices include revisiting the application of refined technology in terms of artificial lift. In order to increase gas sales and reduce emissions/waste during these manual liquids unloading activities, operators should monitor manual liquids unloading events onsite, within close proximity or via remote telemetry to return the wells to normal production operation as soon as possible. Advanced planning to reduce pressure prior to blowing the well down has resulted in reduced emissions.

1. Create differential pressure to minimize the need for venting during unloading activities (artificial lift engine/pump jack, electric submersible pump, etc.)
2. Plunger lifts including automated plunger lifts
3. BMPs - Operators onsite to close vents and monitor the unloading events

Between artificial lift engines, plunger lifts, and supervised manual unloading, one option will result in the lowest emissions relative to the others. This lowest emitting option will serve to mitigate emissions



relative to the others, and should therefore be selected and employed by the operator for liquids unloading at a site..<sup>137</sup>

#### New Wells:

New wells typically have sufficient production rates and flowing velocity so that manual liquids loading is not required. New wells do not require workovers. Workovers are the downhole maintenance activities performed on existing wells that have previously been capable of producing hydrocarbons.

#### Existing Wells:

In order to increase gas sales and reduce emissions/waste during manual liquids unloading activities, operators should monitor manual liquids unloading events onsite, within a close proximity or via remote telemetry to return the wells to normal production operation as soon as possible.

#### How have the emission/waste reductions been measured?

New Mexico Oil and Gas Association report on methane sources and mitigation.

GHGRP 2011-2016 <https://www.nmoga.org/methaneroadmap>

GHGRP emissions trends data is the most reliable source to establish emission reductions, as described in Section 3 below.

Various studies have measured or modeled emissions from manual liquids unloading events.

Characterizing Regional Methane Emissions from Natural Gas Liquid Unloading

<https://pubs.acs.org/doi/abs/10.1021/acs.est.8b05546#>

Temporal Variations in Methane Emissions from an Unconventional Well Site

<https://pubs.acs.org/doi/pdf/10.1021/acsomega.8b03246>

Temporal Variability Largely Explains Difference in Top-down and Bottom-up Estimates of Methane Emissions from a Natural Gas Production Region

<https://www.pnas.org/content/115/46/11712>

Comparison of methane emission estimates from multiple measurement techniques at natural gas production pads

---

<sup>137</sup> The application of artificial lift is very dependent on the specific characteristics of each well. The operating parameters of the wells will dictate the appropriate artificial lift application. The misapplication of artificial lift could result in an increase in methane emissions in the case of plunger lift installations.

<https://www.elementascience.org/article/10.1525/elementa.266/>

Improved Mechanistic Understanding of Natural Gas Methane Emissions from Spatially-Resolved Aircraft Measurements

<https://pubs.acs.org/doi/10.1021/acs.est.7b01810>

Methane Emissions From Process Equipment At Natural Gas Production Sites In The United States: Liquid Unloadings

<https://pubs.acs.org/doi/abs/10.1021/es504016r>

Measurements Of Methane Emissions At Natural Gas Production Sites In The United States

<https://www.pnas.org/content/110/44/17768>

If the artificial lift engine operates properly, the only emissions will be combustion. Depending on conditions, plunger lifts can reduce emissions 90% compared to unmitigated venting. (Source: ICF MACC Report, 2014, available at ,

[https://www.edf.org/sites/default/files/methane\\_cost\\_curve\\_report.pdf](https://www.edf.org/sites/default/files/methane_cost_curve_report.pdf))

How have other jurisdictions, including state, federal, and tribal, reduced emissions/waste from this equipment or process historically? In addition, please identify voluntary reductions achieved whether or not they were in response to a regulatory action/requirement.

Outside of the initial well preparation the number of activities that can be accomplished under the heading of Recompletions/Workovers is so varied with multiple variables that are well specific, regulating venting and emissions associated with these activities is not feasible. Use of best management practice to manage wellbore pressure makes the most sense because it allows operators to determine the best way to reduce venting on a case by case basis specifically from each well as the situation dictates.

The complexity of liquids unloading is why EPA concluded for NSPS OOOOa that imposing specific regulatory requirements for venting and emissions associated with managing wellbore liquids is not feasible.

Requirements for monitoring the activity to manage venting makes the most sense because it allows operators to determine the best way to manage manual unloading on a case by case basis specifically from each well as it changes over time.

**BLM's** final waste prevention rule requires operators to minimize venting and the need for venting and operators must consider alternatives to manual venting and determine if they are infeasible; if manual venting, operators must remain onsite. BLM, 81 Fed. Reg. 83008 (Nov. 18, 2016)

4. 2016 rule: The final rule requires an operator to: (1) Minimize gas vented to unload liquids, consistent with safe operations; (2) optimize the operation of the plunger lift or automated well

control system, at wells equipped with such a system, to minimize gas losses from the system to the extent possible; (3) consider other methods for liquids unloading and determine that they are technically infeasible or unduly costly, prior to manually purging a well for the first time; and (4) comply with specified procedures and document venting events when unloading liquids by manual well purging... The operator must notify the BLM by Sundry Notice within 30 days after the first liquids unloading by manual or automated well purging after the effective date of the rule. Additionally, operators must notify the BLM by Sundry Notice within 30 days after the following conditions are met: (1) The cumulative duration of manual well purging events for a well exceeds 24 hours during any production month; or (2) the estimated volume of gas vented in the process of conducting liquids unloading by manual well purging for a well exceeds 75 Mcf during any production month.

5. The requirements to minimize wasted gas remain essentially the same between the two rules. The main difference between the 2016 and 2018 Rules are that the 2016 Rule required recordkeeping and reporting of liquids unloading events, and the 2018 Rule removed those requirements.

**Colorado** State Regulation to minimize methane emissions in the oil and gas industry:

Colorado, Reg.7, Section XVIII.H.,

<https://drive.google.com/file/d/168v7vMsFJtS7D8BWlnMbaXWA6uZUlyj8/view>

requires operators to use best management practices to reduce emissions and operators must remain onsite during manual unloading. Colorado is proposing new recordkeeping and reporting requirements to gather better data on emissions and BMPs to reduce emissions.

**Wyoming** requires operators use BMPs to minimize emissions and operators must remain onsite during manual unloading (see “blowdown and venting” requirements).

[http://deq.wyoming.gov/media/attachments/Air%20Quality/New%20Source%20Review/Guidance%20Documents/FINAL\\_2018\\_Oil%20and%20Gas%20Guidance.pdf](http://deq.wyoming.gov/media/attachments/Air%20Quality/New%20Source%20Review/Guidance%20Documents/FINAL_2018_Oil%20and%20Gas%20Guidance.pdf) (pps. 13, 19, 24)

**Pennsylvania** requires operators use BMPs to minimize emissions. GP-5A, Section L,

<http://www.depgreenport.state.pa.us/elibrary/GetFolder?FolderID=36120>

What are examples of process changes/modifications that reduce or eliminate emissions/waste from this equipment or process?

**Liquids Unloading:**

- Create differential pressure to eliminate the need to vent a well to unload liquids.
  - Equalize the well
  - Allow the well to build pressure
- Reduce wellbore pressure as much as possible prior to opening to atmosphere via storage tank.

- If possible route the initial volume of gas into the sales line prior to venting. Monitor the pressure and the flowrate to determine the optimal time to vent the well to create the differential pressure to unload the well.
- Monitoring manual liquid unloading events onsite, within a close proximity or via remote telemetry to return the wells to normal production operation as soon as possible.

**Recompletions/Workovers:**

- Open casing to the sales line or the wellhead compressor to reduce the wellbore pressure prior to venting.
  - Equalize with line pressure or compressor suction pressure prior to blow down operations
  - Route gas flow to sales overnight if possible

## Technology Alternatives:

List of technology alternatives with link to information or contact information for the company/developers.

Name/Description of Technology	Link (and contact info for company if available)	Availability	Feasibility	Cost Range (choose one)
BMP – operator onsite monitoring	Operator	In use	High	Low
Artificial lift engine (rod pump)	<a href="https://ediplungerlift.com/products/engine-packages/">https://ediplungerlift.com/products/engine-packages/</a>	In use	Medium-High <sup>138</sup>	Medium
Plunger Lifts	<a href="https://ediplungerlift.com/products/plungers/">https://ediplungerlift.com/products/plungers/</a>	In use (common)	High	Low-Medium

It is important to note that artificial lift deployment is a process that operators carry out to maximize production and production value currently. A well may start off with sufficient production rates to lift liquids out of the wellbore but as the wells production declines below the critical rate, artificial lift must be implemented to optimize production. The operator will select the best artificial lift method based on the well parameters and current conditions. The manual liquid unloading events being discussed in this report are primarily related to the action that must be taken due to an abnormal operating condition, such as an increase in the gas sales line pressure. The increased line pressure causes the well to load up with liquid and production to decrease. This applies to both free flowing wells and wells with plunger lift installations. The act of venting the well through an atmospheric storage tank creates the differential pressure necessary to unload the liquids from the well and return the well back to normal operation.

What technology alternatives exist to reduce or detect emissions? Please list all alternatives identified along with contact information for further investigation of this technology or process.

Artificial lift engines

<sup>138</sup> The feasibility of installing a rod pumping system on a well depends on a number of variables such as the depth, casing size and production rates.

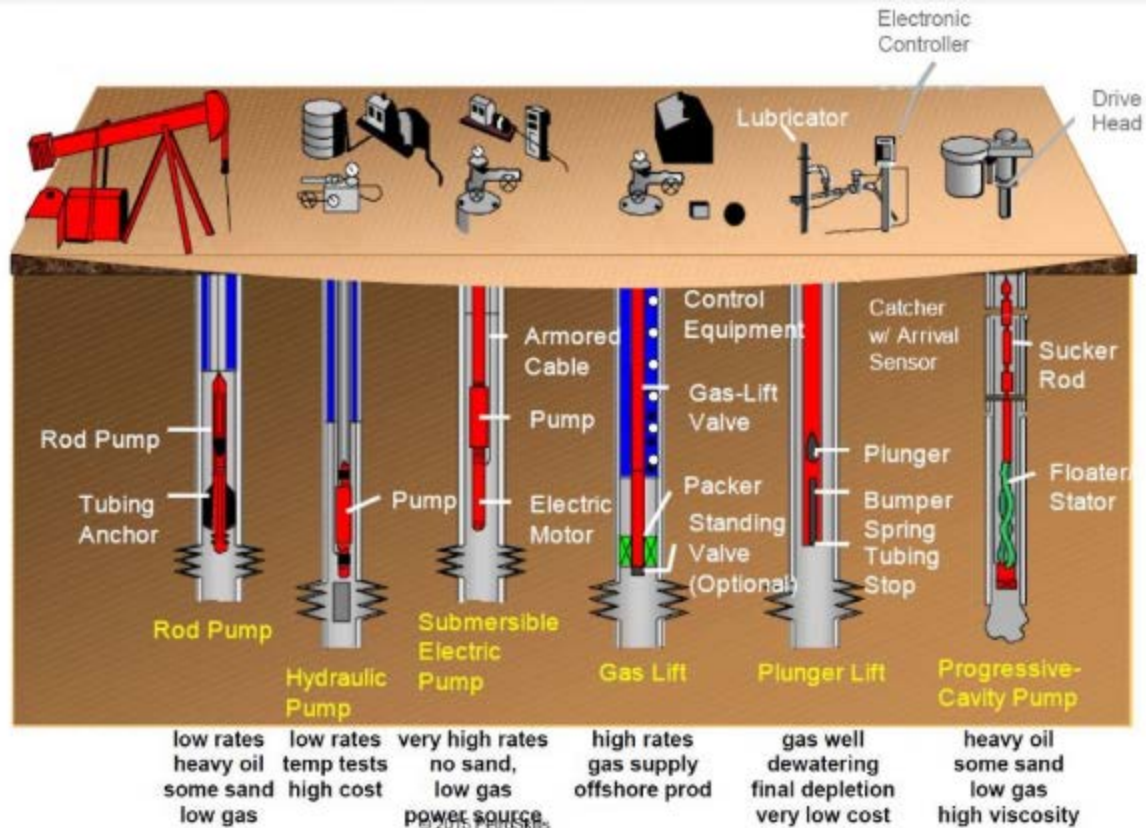

Figure 1-1 Examples of the primary methods of artificial lift.

Source: [https://www.petroskills.com/blog/entry/00\\_totm/sept17-sub-totm-artificial-lift?page=5#.XZO2dm9KjIU](https://www.petroskills.com/blog/entry/00_totm/sept17-sub-totm-artificial-lift?page=5#.XZO2dm9KjIU)

As shown above the various artificial lift methods have limitations and drawbacks. It is critically important to consider the application of artificial lift on an individual well basis.

What are the pros and cons of the alternatives?

Pro: The act of liquids unloading increases production. Mitigating unloading emissions increases production and minimizes emissions. Artificial lift engines can prolong the life of a well and operate at lower pressures than plunger lifts (i.e., wider operating range). (source: <https://www.ourenergypolicy.org/wp-content/uploads/2014/04/epa-liquids-unloading.pdf>)

Con: external power source required, higher cost

What is needed and available for new wells?

See above

### What is needed and available for existing wells?

See above

### What technology alternatives exist for this equipment or process itself?

Plunger lifts (See above schematic)

There are many artificial lift options available and must be selected based on the well parameters and wellsite conditions.

### What are the pros and cons of the alternatives?

See above

Pro: The act of liquids unloading increases production. Mitigating unloading emissions using plunger lifts increases production and minimizes emissions. Estimates indicate production increase of 3 to 300,000 scf/day.

Con: Plunger lifts can operate at low-pressure wells but they do have pressure limits.

## **Costs of Methane Reductions:**

### What is the cost to achieve methane emission reductions?

The cost to achieve methane emission reductions by monitoring the manual venting of a well is tied to the incremental labor cost associated with monitoring each event. The cost to monitor each event is unique in terms of the well configuration, associated pressures (tubing, casing and line).

The cost to reduce the wellbore pressure prior to a workover operation is minimal and is usually offset by the sales proceeds of the gas being sold.

Depends on reduction technology, effectiveness and gas price. Increased productivity in addition to cost benefits of the saved gas can lead to overall savings for artificial lift engines or plunger lift systems.

Table 1 of the “Cost-Effectiveness of Comprehensive Oil and Gas Emissions Reduction Rules in New Mexico” lists per unit costs for installing a plunger lift system in gas wells as \$5.03 per mcf of reduced methane (\$261.56 per tonne).<sup>139</sup>

---

<sup>139</sup> “Cost-Effectiveness of Comprehensive Oil and Gas Emissions Reduction Rules in New Mexico,” Erin Camp, PhD, Nate Garner, Asa Hopkins, PhD, Synapse Energy Economics, Inc., September 13,

What would be the implementation cost?

For new wells?

N/A

Based on results reported by Natural Gas STAR Partners, the cost of implementing artificial lift systems range from \$41,000 - \$62,000. This is an old report and estimates have likely decreased.<sup>140</sup>

Gas STAR estimates for plunger lift installation range from \$2,500 to \$10,000 (*Installing Plunger Lift Systems In Gas Wells* [http://epa.gov/gasstar/documents/ll\\_plungerlift.pdf](http://epa.gov/gasstar/documents/ll_plungerlift.pdf)). Some operators estimate \$15,000 (ICF 2014).

For existing wells?

The cost of monitoring the manual liquids unloading events depends on how long it takes to unload the well.

Are there low-cost solutions available?

Some BMPs, like having an operator onsite to monitor unloading events, are very low cost.

Other methods (like plunger lifts or lift engines) have higher implementation costs, but are often paid for by the additive benefits of increased productivity and saved gas. In fact, ICF estimates an overall benefit of \$0.05/Mcf of methane reduced by installing plunger lifts.

(Source: [https://www.edf.org/sites/default/files/methane\\_cost\\_curve\\_report.pdf](https://www.edf.org/sites/default/files/methane_cost_curve_report.pdf))

If a solution is high-cost, why is that the case?

Artificial lift engines and plunger lifts require technology implementation.

Are there additional technical analyses needed to refine benefits/costs estimates?

N/A

Can develop cost-benefit estimates with industry input.

---

2019, page 9, Table 1, <http://blogs.edf.org/energyexchange/files/2019/09/Synapse-Methane-Cost-Benefit-Report.pdf>.

<sup>140</sup> The cost of artificial lift installation is highly variable depending on the application. The range provide from the Gas STAR Partners does not reflect the cost of all artificial lift cost. The cost of a rod pump installation could exceed \$500,000.00 depending on well depth and production desired pump capacity.



### 3. IMPLEMENTATION

For each piece of equipment or process, please consider the following questions and add other relevant information. If relevant, please identify if the answers are different for large company and small company requirements or are different for well type or basin.

#### **Implementation Feasibility:**

What is the feasibility of implementation (availability of required technology or contractors, potential permitting requirements, potential for innovation)?

#### **Manual Liquids Unloading:**

The lease operators are already deployed in the field to monitor manual liquids unloading events; it is a matter of prioritizing the efforts for monitoring manual liquids unloading events. Recompletion and Workover rig supervisors are experienced and trained in the best ways to minimize venting during the initial well blowdown.

#### **Plunger Lifts and Artificial lift engines:**

Many operators already utilize plunger or artificial engine lifts for liquids unloading (deliquification) activities. Indeed, one of these technologies is likely to result in less unloading emissions than manual unloading. In the event that either plunger lifts or artificial lift engines would lead to less methane emissions relative to manual unloading, an operator should verify that the lift option is technically feasible and implement that technology mitigation option for unloading at the facility.<sup>141</sup>

What is the useful life of equipment?

N/A

What are the maintenance and repair requirements for equipment required for methane reduction?

N/A

---

<sup>141</sup> The application of artificial lift is very dependent on the specific characteristics of each well. The operating parameters of the wells will dictate the appropriate artificial lift application. The misapplication of artificial lift could result in an increase in emissions in the case of plunger lift installations.

## How would emissions be detected, reductions verified and reported?

Each venting event is timed and the emission volume calculated and reported to EPA under the GHGRP program and can be trended over time as illustrated below.

As EDF has noted, due to the reporting threshold and fluctuations in well counts, production, location, and age, the GHGRP data does not reflect all facilities or unloading events or trends thereof. Therefore, GHGRP trends should be considered in that context and not relied upon to accurately represent true liquids unloading emissions trends over time.

In addition to current estimation and reporting methods (see section 2), operators can also directly measure unloading event emissions.<sup>142</sup>

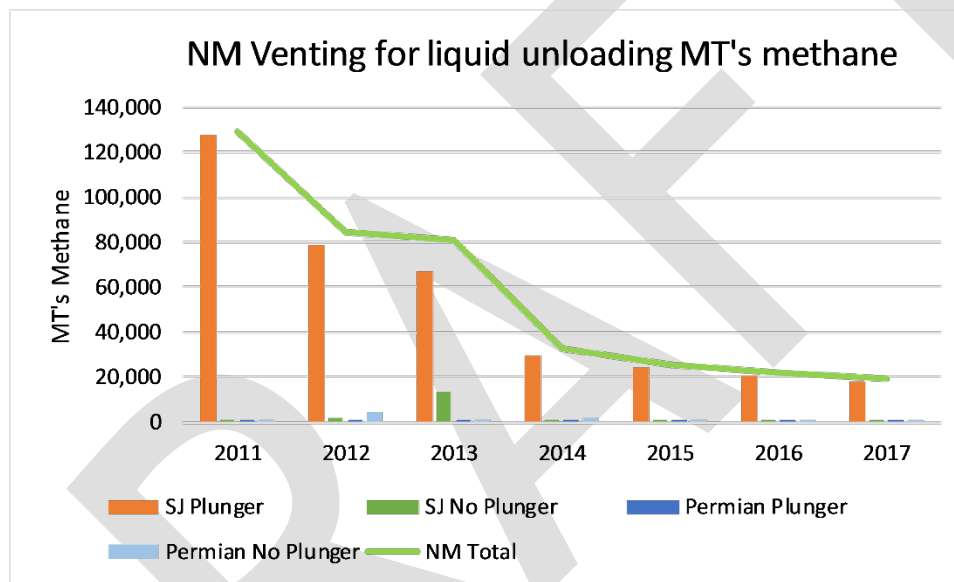

Figure 1: NM LU venting trends

## 4. CHALLENGES AND OPPORTUNITIES TO ACHIEVE METHANE REDUCTION IN NEW MEXICO

For each piece of equipment or process, please consider the following questions and add other relevant information. If relevant, please identify if the answers are different for large company and small company requirements or are different for well type or basin.

What regulatory gaps exist for this equipment or process? Are there regulatory gaps filled by the proposed implementation?

<sup>142</sup> Accurate direct measurement is difficult and can result in backpressure that will impede the process of unloading or blowing down a well.

EPA does not regulate liquids unloading.

Where do conflicting priorities exist between NMED, EMNRD, and NMSLO? Are there opportunities for coordination between these agencies?

N/A

Are there existing regulations related to methane that do not address the intended purpose? Identify any unintended barriers to methane reductions/capture that may hinder proposed processes.

N/A

Other considerations or comments (e.g. particular design or technological challenges/opportunities, co-benefits, non-air environmental impacts, etc.):

Safety is a core value for the industry. Being able to safely and effectively unload or blow down a well is a key point to keep in mind with methane reduction efforts during these activities.

DRAFT

## 5. WORKOVERS AND LIQUID UNLOADING - PATH FORWARD<sup>143</sup>

	OPTIONS	DESCRIPTION AND LINK TO INFORMATION IF AVAILABLE. PLEASE LIST THE BENEFIT THAT COULD BE ACHIEVED THROUGH THIS OPTION AND ANY DRAWBACKS OR CHALLENGES TO IMPLEMENTATION	EMISSIONS REDUCTIONS ARE EASY TO ACHIEVE AND ARE COST EFFECTIVE  1 = EASY 5 = HARD	REPORTING, MONITORING AND RECORDING OPTIONS, INCLUDING REMOTE DATA COLLECTION	IS THIS OPTION HELPFUL IN THE SAN JUAN BASIN, PERMIAN BASIN OR BOTH
7.1	Create differential pressure to eliminate the need to vent a well to unload liquids.	<ul style="list-style-type: none"> <li>▪ Equalize the well</li> <li>▪ Allow the well to build pressure</li> </ul> <p>Colorado rule [page 211]</p>	1 2 3 4 5		San Juan  Permian  Both
	<p>COMMENT</p> <p>A. Explanation of differential pressure [page 201]: The well pressure has to be greater than the pipeline pressure for the well to flow. If the well is also unloading liquids then the well pressure will have to be greater than the pipeline pressure plus the hydrostatic pressure of the liquid plus the friction of the liquids to flow. This differential pressure can be maximized by several methods depending on the wells characteristics. For example, shutting in the well for longer periods, or minimizing the after flow after the liquid slug or plunger arrives at the surface, or tripping the plunger more often are methods of creating the required differential pressure for the well to flow.</p>		SUGGESTION TO MAKE THIS OPTION MORE WORKABLE:		
7.2	As a best management practice, minimize volume vented for manual liquid	Route the initial volume of gas to the sales line prior to venting, monitor flow rate and pressures and vent once	1 2 3 4 5		San Juan  Permian

<sup>143</sup> The format of the Path Forward table evolved over the course of the meetings as the group tried to identify the best method for capturing the most useful information. As a result, there is some variation in the table headers from topic to topic in the final consolidated report.

	unloading events by lowering the wellhead pressure	the rate or pressure indicate additional differential pressure is necessary to unload.			Both
	COMMENT		SUGGESTION TO MAKE THIS OPTION MORE WORKABLE:		
7.3	As a best management practice, monitor manual venting onsite, in close proximity or via remote telemetry.	Reduce the venting time and emission volume by returning well to normal operation as soon as possible			
	COMMENT A. Place performance standards on monitoring systems to ensure a minimum level of accuracy. [page 208]		SUGGESTION TO MAKE THIS OPTION MORE WORKABLE:		
7.4	As a best management practice, minimize venting for workovers by lowering the wellhead pressure as much as possible prior to blow down.	Open casing to the sales line or the wellhead compressor to reduce the wellbore pressure prior to venting. <ul style="list-style-type: none"> <li>▪ Equalize with line pressure or suction pressure prior to blow down operations.</li> </ul>			
	COMMENT A. Reduce wellbore pressure as much as possible prior to opening to atmosphere via storage tank. [BMP] [page 211]  B. There are not rules that address workovers in other states. [page 202]  C. BMPs need to be flexible and not dictated.  D. Maybe guidance documents not regulations for BMPs.		SUGGESTION TO MAKE THIS OPTION MORE WORKABLE:		
7.5	As a best management practice, consider the lowest-emitting liquids unloading	Select the lowest-emitting, technically feasible option if economically viable.			

	option between (1) artificial lift, including plunger lifts, and (2) supervised manual unloading. Verify the option is technically feasible and implement that option for liquids unloading at the facility.	The different options available for artificial lift are considered to optimize well production. Well conditions as well as other considerations such as availability of adequate, reliable electricity and well economics are considered prior to installation.			
	COMMENT A. We're focused on liquids unloading and not artificial lift.		SUGGESTION TO MAKE THIS OPTION MORE WORKABLE:		
7.6	Establish a liquids unloading emissions limit (e.g., emissions per event, emissions per facility, or some combination thereof)	Operator may choose any of the three unloading options (or others that become/are available) as long as they can demonstrably meet the established emissions limit.			
	COMMENT A. It would be very hard to set a predetermined limit on emissions given all of the different circumstances in the field. [page 210]  B. What would be the recourse if a well could not meet a predetermined limit? Premature plugging?  C. Given the differences in individual well and reservoir characteristics it would be difficult to have a single emissions limit per event. [page 210]  D. Path forward 6.6 is not a control method that operators can take to reduce methane emissions but the goal of our whole process. There are too many variables involved at each wellsite to predetermine what an allowable emission limit should be.		SUGGESTION TO MAKE THIS OPTION MORE WORKABLE:		

# SECTION 8, SEPARATORS / HEATERS / STORAGE VESSELS

Discussion for MAP members on October 24, 2019

---

---

NOTE: The focus of this report is processes, and the associated equipment, directly related to the release or capture of methane gas. We are not requesting information on processes/equipment that are not related to the release or capture of methane gas.

## 1. DESCRIPTION OF PROCESS AND EQUIPMENT

Provide a description of the processes and/or equipment used in oil and/or gas extraction for this topic. Note that this report template will be used for all topics of the MAP review and, thus, not all questions or information may be relevant for each topic. If information is not relevant, indicate N/A. Note any differences expected for differing well types, industry sector, or basin location.

### Technical description of the process or equipment:

There are two primary basins in New Mexico. The San Juan Basin produces primarily natural gas with the possibility of some crude/condensate. The Permian Basin produces primarily oil with associated natural gas. Production facility operators process (separation and treating) the production (oil, gas and water) from the wells to meet pipeline/truck specifications for sales (oil and gas) or disposal/recycling (produced water). Process equipment in use can date back to pre-1940's.

Production facilities can vary based on many factors. Design considerations include, but are not limited to:

- 1) Rates – Oil, gas, water, gas-to-oil ratio (GOR), decline, etc.
- 2) Composition – dry gas, heavy oil, light condensate, sweet (low H<sub>2</sub>S), sour (high H<sub>2</sub>S), etc.
- 3) Product Takeaway Specifications – natural gas water content, Reid Vapor Pressure, API gravity, etc.
- 4) Secondary, Tertiary, etc. Recovery Strategies – Gas Lift, Electric Submersible Pump (ESP), Beam Pumping, etc.
- 5) Location – Equipment size/count/spacing constraints, automation strategy, storage strategy, etc.
- 6) Regulatory/Permitting Requirements – recovery, combustion, venting strategies

Common equipment used in production facilities includes:

- 1) Pressure Vessels (“Separators”) – Vertical, horizontal, 2-Phase (vapor/liquid), 3-Phase (vapor/light-liquid/heavy-liquid), heated (“heater treaters” or “production units”), un-heated, etc.
- 2) Storage Tanks
- 3) Pumps
- 4) Compressors
- 5) Combustion Equipment – flares, enclosed combustors, etc.

## 6) Fluid loading points

NOTE: Production facilities often contain additional equipment including compressors, pneumatic devices, flares, and vents, which are discussed in separate MAP topic papers. Leak detection and repair (LDAR) for pressure vessels and storage tanks is also discussed in a separate MAP topic paper. Unless otherwise stated, the process descriptions and operational discussions throughout this paper assume a production facility that is properly authorized and operating under normal (non-upset) conditions.

A general process description for production facilities is below. It should be used in conjunction with the below process flow diagram with accompanying annotations. Note: the center box shows the 3 potential ways of managing vent gas: recovery (typically compression to sales or site use), combustion (typically flaring), or venting. See page 22 for further description about the drivers and challenges when determining a particular vent gas management strategy.

From the wellhead, the combined production stream (oil, gas and water) flows to inlet separation processes (i.e. some configuration of 2-Phase and 3-Phase separation) where it is mechanically separated into independent streams. After initial separation, and if necessary, secondary stages of separation are typically applied to

- 1) oil (e.g. "Heater Treaters") for further conditioning to meet sales specifications
- 2) gas (e.g. "Sales Separators") to prevent inadvertent flow of oil to gas takeaway due to upset conditions (e.g. dump valve malfunction)
- 3) water (e.g. "Free Water Knockouts" and "Gun Barrels") to prevent inadvertent flow of oil to water takeaway due to upset conditions (e.g. dump valve malfunction)

Beyond secondary stages of separation, it is common to flow oil to vapor recovery tower ("VRT") to safely recover as much flash gas as possible prior to storage. Oil will ultimately flow to storage tanks and be sold (typically via Lease Automatic Custody Transfer (LACT) Unit) to pipeline or truck. Water will ultimately flow to storage tanks and be sent to disposal/recycle via pipeline or truck. Under normal operating conditions, associated gas (from inlet separation) is sold via pipeline. Under upset conditions, associated gas must be recovered, combusted or vented. Vapor from all other stages of separation and storage is recovered, combusted or vented.



ANNOTATIONS

- |                               |  |                           |                                 |
|-------------------------------|--|---------------------------|---------------------------------|
| 1 - REMOTE "OFF-PAD" WELLHEAD | 6 - INLET 3-PHASE SEPARATOR            | 12 - BACK PRESSURE VALVE  | 18 - ADDITIONAL WATER TANKS     |
| 2 - LOCAL "ON-PAD" WELLHEAD   | 7 - TEST SEPARATOR                     | 13 - ULPS/VRT             | 19 - PVRV                       |
| 3 - ADDITIONAL WELLS          | 8 - TEST PRODUCTION MANIFOLD           | 14 - FWKO/GUN BARREL      | 20 - THIEF HATCH                |
| 4 - INLET 2-PHASE SEPARATOR   | 9 - BULK SEPARATOR                     | 15 - OIL STORAGE TANK     | 21 - LACT                       |
| 5 - PRESSURE RELIEF VALVE     | 10 - HEATER TREATER                    | 16 - ADDITIONAL OIL TANKS | 22 - WATER TRANSFER PUMP        |
|                               | 11 - SALES GAS "LAST CHANCE" SEPARATOR | 17 - WATER STORAGE TANK   | 23 - HYDROCARBON GAS STRATEGIES |

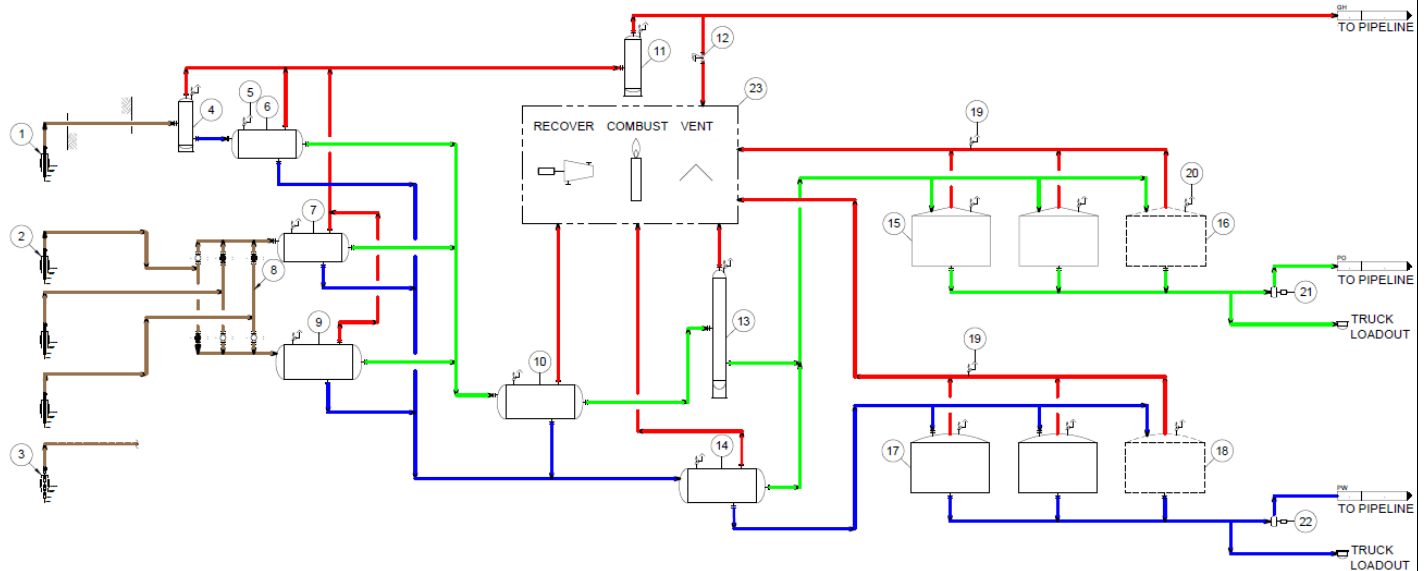

In its most basic form, a production facility is used to process raw production (oil, gas and water) to meet sales specifications. The goal is to maximize recovery while minimizing cost. The challenge is to do it effectively, safely and within compliance. Our tools are pressure, temperature, gravity, time, chemistry, surface area and agitation.

**1 - REMOTE "OFF-PAD" WELLHEAD**

Wellheads may be located remotely away from the production facility. This distance can be anywhere from 50' to 2 miles or longer. Production is delivered to the facility via a "flowline".

**2 - LOCAL "ON-PAD" WELLHEAD**

Wellheads and production facilities may even share the same pad. It is also not uncommon for a production facility to have both remote and local wellheads.

**3 - ADDITIONAL WELLS**

Production facilities are not limited by well count. They can be designed to accommodate ranges from single well applications to an entire section or more.

**4 - INLET 2-PHASE SEPARATOR (PRESSURE VESSEL)**

Typically used to separator gas from bulk liquids (oil & water). Note that vertical separators are more common in higher GOR applications. It is also important to note that all vessels may be heated or unheated.

**5 - PRESSURE RELIEF VALVE**

Safety device designed to prevent critical failure during upset conditions. PRV's used on pressure vessels typically use simple spring-loaded actuators.

**6 - INLET 3-PHASE SEPARATOR (PRESSURE VESSEL)**

Typically used to separate all three production streams (gas, oil & water). Note that horizontal separators are more common in lower GOR applications.

**7 - TEST SEPARATOR (PRESSURE VESSEL)**

It is common for operators to employ either a "single well separation" or a "test well separation" strategy. Single well separation strategies utilize an inlet separator for every well (typically for measurement purposes). Test well

separation strategies employ a test separator that cycles wells for a certain period (remaining wells flow to bulk separator when not in testing).

#### 8 - TEST PRODUCTION MANIFOLD

Used in test separation strategies to direct flow of wells to either test separator or bulk separator.

#### 9 - BULK SEPARATOR (PRESSURE VESSEL)

Used in test separation strategies for wells not in their testing cycle.

#### 10 - HEATER TREATER (PRESSURE VESSEL)

Typically employed as a second stage of separation. Its purpose is to further “treat” the oil with heat and additional residence time to ensure it meets sales specifications.

#### 11 - SALES GAS "LAST CHANCE" SEPARATOR (PRESSURE VESSEL)

Used to recover any additional entrained hydrocarbon liquid within the gas stream that may have slipped previous stages of separation.

#### 12 - BACK PRESSURE VALVE

A “BPV” hold processes to a desired pressure for a facility to operate as designed. The illustrated BPV in the diagram is specifically used as a common response to upset (high) sales line pressure conditions.

#### 13 - ULPS/VRT (PRESSURE VESSEL)

A VRT/ULPS is a special type of 2-Phase separator designed to operate at as low of a pressure as possible to minimize flash gas in storage vessels. It is typically used in conjunction with a VRU to deliver flash gas to sales. It was designed out of the need to avoid risks associated with vapor recovery from near atmospheric storage vessels.

#### 14 - FWKO (PRESSURE VESSEL)/GUN BARREL

Used to prevent oil from flowing to water storage due to imperfect separation or upset conditions (e.g. dump valve FAIL-OPEN malfunction).

#### 15 - OIL STORAGE TANK

Oil tanks store product prior to being delivered to sales via truck or pipeline. Their height is used as a driving force (i.e. head pressure) to make delivery easier. They are typically constructed with steel and have a pressure rating between 0-1 PSIG (0-16 OSIG). It is critical to note that this small pressure range yields drastically different operational strategies.

#### 16 - ADDITIONAL OIL TANKS

The quantity of tanks is determined by rate and is a risk-based decision from the operator.

#### 17 - WATER STORAGE TANK

Water tanks store byproduct prior to being delivered to sales via truck or pipeline. They are typically constructed with fiberglass or steel and have a pressure rating between 0-1 PSIG.

#### 18 - ADDITIONAL WATER TANKS

The quantity of tanks is determined by rate and is a risk-based decision from the operator.

#### 19 – PVRV

A Pressure-Vacuum Relief Valve is a safety device designed to prevent critical failure during upset conditions. The illustrated PVRV in the diagram is specifically used on storage vessels. Due to the small design pressure range of storage vessels, small differences in set pressure can yield significantly different operating strategies.

#### 20 - THIEF HATCH (Maintenance hatch)

An opening in the top of a storage tank. Typically used by operators for a variety of reasons, these are sized similar to the storage tank PVRV. The thief hatch allows tank access for a thief or other level measuring device. Opening and closing of a thief hatch is a manual operation by an operator.

#### 21 – LACT

Used to deliver oil to sales via pipeline or truck at required pressures typically higher than atmospheric.

#### 22 - WATER TRANSFER PUMP

Used to deliver water to disposal/recycle via pipeline or truck at required pressures typically higher than atmospheric.

#### 23 - HYDROCARBON GAS STRATEGIES

Gas streams operating below pipeline pressure must either be recovered, destroyed or vented. Each strategy comes with its own benefits and challenges. Examples of engineering considerations can be found in the chart below. Utilization ranges from a single strategy to a combination of all three. As noted in the chart, the design complexity and costs increase as one progresses from venting to recovery of storage tank vents. In general, the more complex combust/recovery installations are at larger surface facilities where there is adequate gas volume for capture, appropriate available infrastructure, such as grid power, and sufficient production to support the installation and operational costs.

	RECOVER	COMBUST	VENT
<b>STRENGTHS</b>	<ul style="list-style-type: none"> <li>• Gas to Sales</li> <li>• &gt;95% Efficient</li> <li>• Centralized Production Opportunities</li> <li>• OOOOa Enforceable if Applicable</li> </ul>	<ul style="list-style-type: none"> <li>• Not as complex as recovery               <ul style="list-style-type: none"> <li>- No 3<sup>rd</sup> Party Maintenance</li> </ul> </li> <li>• More reliable than recovery</li> <li>• &gt;95% Efficient</li> <li>• OOOOa Enforceable is Applicable</li> </ul>	<ul style="list-style-type: none"> <li>• Negligible Complexity</li> <li>• Negligible Cost</li> </ul>
<b>CHALLENGES</b>	<ul style="list-style-type: none"> <li>• Requires Compression</li> <li>• Requires Power/Fuel</li> <li>• Measurement</li> <li>• Complexity               <ul style="list-style-type: none"> <li>- Mechanical Design Considerations                   <ul style="list-style-type: none"> <li>▪ Suction Piping Design</li> <li>▪ Discharge Piping Design</li> <li>▪ Placement of Equipment</li> </ul> </li> <li>- I&amp;E Design Considerations                   <ul style="list-style-type: none"> <li>▪ Installation of Instrumentation</li> <li>▪ Selection of Instrumentation</li> <li>▪ PLC</li> <li>▪ Communications</li> </ul> </li> <li>- Vendor/Unit Selection</li> <li>- (Tanks) Incorrect Composition                   <ul style="list-style-type: none"> <li>▪ Oxygen</li> <li>▪ Blanket Gas</li> </ul> </li> <li>- (Tanks) Set Point Limitations                   <ul style="list-style-type: none"> <li>▪ Retrofit Complications</li> </ul> </li> </ul> </li> <li>• Area Classification</li> <li>• Downtime Considerations</li> <li>• Maintenance               <ul style="list-style-type: none"> <li>- Service in the area?</li> </ul> </li> <li>• Operational Deviations               <ul style="list-style-type: none"> <li>- Training</li> </ul> </li> </ul>	<ul style="list-style-type: none"> <li>• Requires Flare/VCU               <ul style="list-style-type: none"> <li>- “Off the shelf”</li> <li>- Custom Design</li> </ul> </li> <li>• Requires Power/Fuel</li> <li>• (LP Only) Difficult to Measure</li> <li>• Complexity               <ul style="list-style-type: none"> <li>- Mechanical Design Considerations                   <ul style="list-style-type: none"> <li>▪ Vent Header Design (<math>\Delta P</math>)</li> <li>▪ Stack Height</li> </ul> </li> <li>- I&amp;E Design Considerations                   <ul style="list-style-type: none"> <li>▪ Installation of Instrumentation</li> <li>▪ Selection of Instrumentation</li> <li>▪ PLC</li> <li>▪ Communications</li> </ul> </li> <li>- (LP Only) Smokeless Combustion</li> </ul> </li> <li>• Incorrect Composition               <ul style="list-style-type: none"> <li>- Arrestor Limited Protection</li> </ul> </li> <li>• Large Radius of Exposure</li> <li>• Downtime Considerations</li> <li>• Operational Deviations               <ul style="list-style-type: none"> <li>- Training</li> <li>- Thief Hatches</li> </ul> </li> <li>• Construction Deviations               <ul style="list-style-type: none"> <li>- Equipment Verification</li> </ul> </li> </ul>	<ul style="list-style-type: none"> <li>• 0% Efficient</li> <li>• Safety: Risk to Personnel               <ul style="list-style-type: none"> <li>- Toxicity</li> <li>- Asphyxiation</li> <li>- LEL</li> </ul> </li> </ul>

	<ul style="list-style-type: none"> <li>- Thief Hatches</li> <li>- Suction Pressure Control Sensitivity <ul style="list-style-type: none"> <li>▪ VFD, etc.</li> </ul> </li> <li>• Construction Deviations</li> <li>- Equipment Verification</li> </ul>		
--	---	--	--

24 - Vent pipeline-Generally denotes pipelines that allow for pressure equalization for the head space of vessels. Use of the word “vent” does not necessarily imply that the vessel is vented to atmosphere-rather than the vessel utilizes a vent system to manage vapors produced in vessels.

<https://www.epa.gov/natural-gas-star-program/overview-oil-and-natural-gas-industry>

[https://library.e.abb.com/public/34d5b70e18f7d6c8c1257be500438ac3/Oil%20and%20gas%20production%20handbook%20ed3x0\\_web.pdf](https://library.e.abb.com/public/34d5b70e18f7d6c8c1257be500438ac3/Oil%20and%20gas%20production%20handbook%20ed3x0_web.pdf)

Mid-stream tank configuration description:

On the midstream side, storage tanks are used in a variety of ways. At compressor stations, liquids from inlet scrubbers, compressors and glycol dehydrators can be temporarily stored in tanks. Midstream storage tanks can also contain liquids that may accumulate in gathering system lines over time. These liquids from lines can be removed/recovered by “pigging” the line. Pigging is a process involving a plug that is forced through the line, pushing accumulated liquids ahead of it to a pig catching station where it is recovered to tankage. The process of pigging only happens periodically as needed and results in short term emission events, not continuous. These emission events are typically covered by the operating permit for the site where the tank is located. Volume of liquids in the lines removed by pigging varies greatly on the type of product moving through the line and the size of the pipe.

Below are additional technical details.

**Pressure Vessels:**

The American Society of Mechanical Engineers (ASME) defines pressure vessels as “containers for the containment of pressure, either internal or external.” Two common exemptions from this definition are

- 1) “Vessels having an internal or external pressure not exceeding 15 psi”
- 2) “Vessels having an inside diameter, width, height, or cross sectional diagonal not exceeding 6 in., with no limitation on length of vessel or pressure”

Based on this definition, it is reasonable to assume that all separators (e.g. Inlet 2Phase, Heater Treaters, Sales Separators, etc.) are pressure vessels. There could be some exception applied to VRT’s based on individual design considerations. One glaring clarification to make, however, is that storage tanks are not pressure vessels.

The primary function of pressure vessels in the oil & gas industry is phase separation. The three basic separation principles applied are:

- 1) Mechanical separation of immiscible fluids using gravity
- 2) Partial vaporization of a homogenous, single-phase solution using heat transfer
- 3) Flash vaporization of a homogenous, single-phase solution using pressure reduction

Pressure vessels may be

- 1) Oriented vertically or horizontally
- 2) Heated or unheated
- 3) Configured for 2-Phase (V/L) or 3-Phase (V/L/L) separation
- 4) Outfitted with internals (plates, weirs, etc.)

5) Etc.

It is common practice to operate pressure vessels at as low of a pressure as possible. The two primary constraints are

- 1) Having enough pressure to get into the gas sales line (Inlet separation only) and
- 2) Having enough pressure to dump liquid(s) to the next stage of the process.

Higher pressures yield more flash vaporization downstream in the process. Pressure is typically maintained on the vessel by use of a valve. There are a variety of valves for a variety of applications.

LINK: <https://blog.kimray.com/what-does-back-pressure-mean-and-why-is-it-important/>

Liquids flow out of the vessel using a liquid level controller in conjunction with a level control (“dump”) valve. Once liquid in the vessel reaches a determined set point, the level controller will send a signal to an actuator that will open or close the valve accordingly. Three common types of liquid level controllers are

- 1) Discrete (1/0) Switch – Sends a command to either open or close. Does not have a range. Can have either a pneumatic or electric signal to a respectively pneumatic or electric actuator. Typically used on scrubber (pressure vessels in low liquid dropout service (e.g. fuel scrubbers)) dumps.
- 2) Displacer – Sends a ranged command to either open or close. The more the displacer travels, the more the actuator/valve responds. Can have either a pneumatic or electric signal to a respectively pneumatic or electric actuator. It is common for displacers to be configured as either “snap” or “throttle”. A snap controller yields a more aggressive actuator response to displacer travel and is useful in applications with lower liquid rates. A throttle controller yields less aggressive actuator response and is useful in applications where it is important to maintain a certain liquid level within a process.
- 3) Mechanical – Sends a ranged command to either open or close. The more the float travels, the most the valve responds. Mechanical floats are mechanically attached to the valve.

LINK: <https://blog.kimray.com/valve-actuator/>

LINK: <https://blog.kimray.com/how-does-the-kimray-dump-valve-work/>

LINK: <https://blog.kimray.com/how-to-operate-the-kimray-high-pressure-control-valve/>

LINK: <https://blog.kimray.com/valve-sizing-3-most-important-factors-selecting-control-valve/>

Pneumatic actuators are used to manage the fluids in the separator, heater treater, and storage vessels, and require the use of a gas. Pneumatic operations are discussed in a separate MAP Topic paper.

Trim style is also important to consider and is selected based on how a valve needs to operate as a function of stem travel.

LINK: <https://blog.kimray.com/3-types-control-valve-trim/>

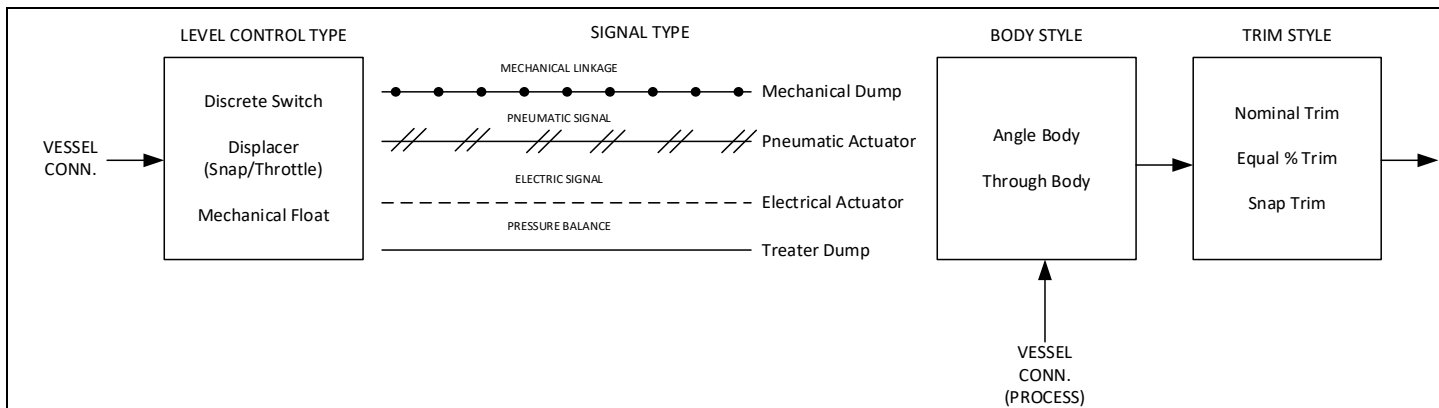

The below flowchart depicts common configurations. Configuration selection considers cost, availability of power/instrument air/instrument gas, reliability, required dump rates, etc. The impact of selection is the instantaneous dump rate yielded. It is important to consider instantaneous rates when designing a facility.



Dump valve failures do occur and typically result in the valves inability to fully close. This can be caused by a stuck debris (plug pieces, sand, etc.) or worn seats, stems and balls. Critical failure (100% Cv) of a dump valve is rare and is considered an upset condition that requires engineered safety controls (i.e. pressure relief valves). Regardless of the extent of the failure, if it is left unattended it will eventually empty the vessel of all liquids, allowing gas to leak or “blow by” to the next stage of the process. If communications are available on site, it is possible to install a level switch that will trip in a low liquid event.

For simplicity, pressure vessels used at production facilities are organized into one of three categories

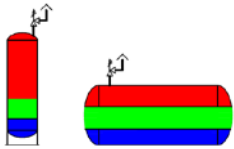
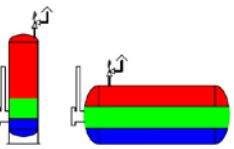
- 1) Normal Pressure Vessels
- 2) Heater Treaters
- 3) VRT's

Category	Pressure	Temperature	Separation Principle(s)	Comment
Normal Pressure Vessels 	15-1440 PSIG	Variable	Mechanical Flash Vaporization	Inlet separators, 2Phase, 3Phase, Sales Separators, FWKO, etc.
Heater Treaters 	< First Stage	80-140 °F	Mechanical Flash Vaporization Heat Transfer	Uses fuel gas for combustion
VRT's 	0-5 PSIG	Variable	Mechanical Flash Vaporization	Gravity feeds to tanks; no dump valve

It is critical to note that the purpose of the VRT is to be used in conjunction with a VRU (where the gas can be sold) to minimize flash vaporization in the tanks. While using a VRU to pull vapors directly from the tanks is theoretically feasible, the potential risk of introducing oxygen into a hydrocarbon rich vapor space adds complexity to the design. If there is inadequate gas produced by flash vaporization in the tanks, the compressor will pull the pressure of the tank below zero (vacuum). The result would be the activation of a PVRD which would allow air to be drawn into the head space of a tank and commingled with the flash gas sent to sales. Introducing oxygen into a hydrocarbon rich vapor space also creates the possibility of an explosive atmosphere. Failure of the PVRD to draw in adequate air to relieve the vacuum may result in tank collapse/failure. In addition, introduction of air/oxygen into the gas stream may result in rejection of the gas due to

composition specification. The result could be flaring of additional gas at the site due to the quality issues. Blanket gas systems can be installed to mitigate the vacuum/introduction of air issue. However, there is disagreement on the use of blanket gas as a viable solution to this challenge. For sites with low production of flash gas and/or limited access to appropriate electrical power other methods may produce more emissions than the alternative. Regardless, the use of a VRT can reduce phase separation VOC's in the tanks by 90+%.

Typical 3-Phase Separator:

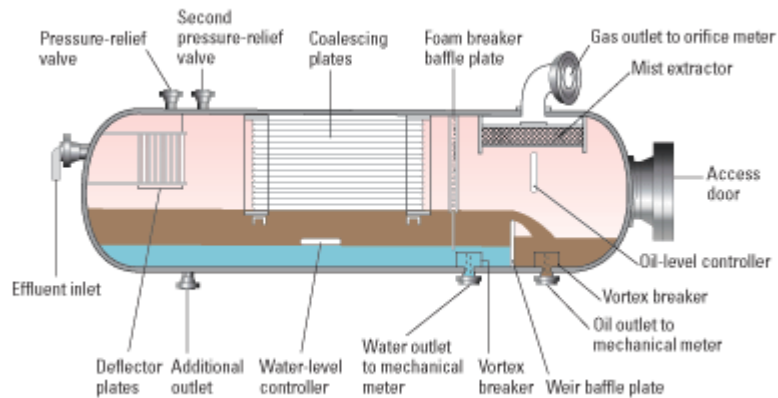

<https://www.glossary.oilfield.slb.com/en/Terms/s/separator.aspx>

<https://hy-bon.com/blog/use-the-power-of-the-vapor-recovery-tower/#targetText=Using%20a%20vapor%20recovery%20tower,a%20crude%20oil%20storage%20tank.>

VRT training: <https://hy-bon.com/products/vrt/>

[https://petrowiki.org/Oil\\_and\\_gas\\_separators](https://petrowiki.org/Oil_and_gas_separators)

Separator design manual: [https://pacs.ou.edu/media/filer\\_public/c9/4a/c94a97ac-9609-4262-ab06-b7b2dda1c4fa/3\\_oil\\_and\\_gas\\_separation\\_design\\_manual\\_by\\_c\\_richard\\_sivalls.pdf](https://pacs.ou.edu/media/filer_public/c9/4a/c94a97ac-9609-4262-ab06-b7b2dda1c4fa/3_oil_and_gas_separation_design_manual_by_c_richard_sivalls.pdf)

Figure of Typical Vertical Heater Treater:

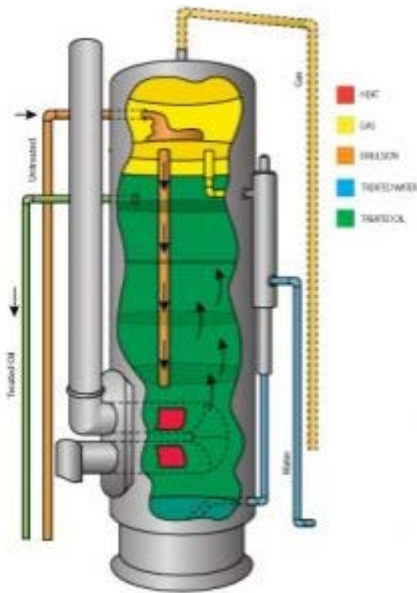

(Reference: [TCEQ Upstream O&G Heaters and Boilers Final Report, August 30, 2013](https://www.tceq.texas.gov/assets/public/Response/Upstream_O&G_Heaters_and_Boilers_Final_Report_August_30_2013.pdf))

<https://naturalgasindustryhub.com/what-are-heater-treaters/>

### Storage Vessels (Tanks):

Tanks are designed to operate at “near atmospheric” pressure. It is common practice to refer to their design rating in ounces of pressure instead of pounds. One (1) pound per square inch gauge (psig) = 16 ounces per square inch gauge (osig).

In the most recent version of API 12F (January 2019), tanks built to the standard have a design pressure of 16 (ounces per square inch gage) osig (with provisions for 24 osig during emergency upset conditions). However, existing tanks throughout New Mexico can have a design pressure ranging from 0-16 osig and be constructed with either carbon steel or fiberglass (only used in water service). 8 osig for carbon steel tanks and 4 osig for fiberglass tanks are likely the most common at existing sites.

Tanks in the production sector of the oil and natural gas industry are used to temporarily store segregated oil and water. Storage vessels can be installed as a single unit or in a grouping of similar or identical vessels, commonly referred to as a “tank battery.” The reason for temporary storage is for feasibility of takeaway via pipeline or truck. In cases of pipeline (and pumps in general), it is important to minimize the number of times fluid drivers cycle on and off. There are also net positive suction head requirements to consider when pumping oil. In cases of trucking, it is important to have an appreciable load for takeaway. At sites where multiple tanks are located, tanks are often connected by a manifold. The method of tank operation varies depending on site-specific conditions.

Pipeline is the preferred method of takeaway but requires both a pipeline and available power. Trucking is the other option and has emissions associated with it that are quantified using EPA’s AP-42 Emissions Factors (Section 5.2). Vapor balance return lines allow operators to take credit for reduced emission factors and are relatively easy to install. However, the challenge is in finding trucks that are certified in the practice of vapor balance. It is also difficult for operators to enforce the use of vapor balance. There is a perception that truck loading is the primary cause for left open thief hatches, but there is lack of industry data to corroborate.



The industry considers three separation mechanisms from storage tanks:

- 1) Flash vaporization of a homogenous, single-phase solution using pressure reduction
- 2) "Working" Losses due to changes in tank levels from filling/emptying
- 3) "Breathing" Losses due to changes in ambient conditions throughout any given day

Vapors created from this separation must either be recovered, destroyed or vented. For recovery and destruction strategies, it is paramount to adequately maintain pressure on storage tanks by use of thief hatches, pressure/vacuum relief valves and emergency relief valves. Vapor will flow to the path of least resistance. If a storage tank relief device is not properly specified or correctly installed, it can become the path of least resistance. If a storage tank relief device is not properly maintained (i.e. seal failures, worn springs, etc.), it can become the path of least resistance. If a thief hatch is left open after gauging, truck loading, maintenance, etc., it will definitely become the path of least resistance. This is a challenge for storage tanks because the range of control is relatively small and very sensitive to any errors or malfunction. It is especially challenging for existing locations that have even less of a design operating pressure. This plays a pivotal role in NSPS OOOOa compliance determination for closed vent systems if applicable.

Vapor Recovery Units (VRUs) work by using a small compressor to capture and compress the vapor emissions from the oil at low to near atmospheric pressures, reducing the amount of gas that is sent to the vapor combustion device from the storage tanks. They may be operated in conjunction with VRTs, where they compress the flashed gas for sales upstream of the tanks. VRU's can also be tied directly to the tank vent header system or CVS as long as there is an adequate gas blanket system installed to capture emissions directly from the tank and routed to a sales point instead of a combustion device. The VRU compressor is driven by a small natural gas or electric engine. The size is determined by site-specific conditions and production rates. At sites where there is not an adequate and/or reliable electric power source, natural gas engines must be used. VRU's, like all compressors, are rate limited; meaning, available compressors will be too large to run efficiently to control the vapors when emissions are very low. In some cases, VRT/VRU installations may be temporary. Installations would normally occur during the early phase of a well's life when production is highest. This equipment may be removed later when production falls below an economic or operational feasibility threshold. Installation of VRU's on tank headers is generally not recommended due to the safety and gas quality concerns this may introduce to the process (see page 7). In general, for sites authorized under NOI the NMED does not consider different operating strategies. Sites are evaluated for the maximum emissions expected from a site and do not consider the emission reductions/gas capture associated with the use of VRT's/VRU's.

<https://www.sciencedirect.com/topics/engineering/oil-storage>

<https://www.epa.gov/natural-gas-star-program/estimates-methane-emissions-sector-united-states>

Provide the segment(s) of the industry that the equipment or process is found:

The equipment/process is found in the upstream, midstream, and transmission segments.

Describe how the equipment or process is used:

Addressed in previous section.

Provide the common process configurations that use this equipment or process:

Addressed in previous section.

What is the distribution of the equipment or process across business segments?

Addressed in previous section.

#### How has this equipment or process evolved over time?

Tank standards changed to move from 8 oz to 16 oz pressure set points due to a change in API Standard 12F in January 2019 (available by subscription at <https://www.monogramwebstore.org/publications/item.cgi?fce92c8f-40c7-4108-90d2-ba38757d174c>). An increase in the pressure rating allows operators to set pressure relief devices at a higher setpoint, decreasing the likelihood of triggering relief devices that could vent to atmosphere. However, not all tanks are operated at these higher pressure ranges under normal operating conditions. It is important to note that retrofitting/replacing tanks is a significant economic challenge. Replacing tanks requires existing tanks to be cleaned, tested/treated for naturally occurring radioactive material (NORM), have piping removed, transported, and sold at a price that hardly recovers any value. Installing a new tank is roughly twice the cost of the tank. Retrofitting tanks really only applies when an operator decides to switch a tank from oil service to water service due to hazards associated with fiberglass tanks. The challenge in this is adequately protecting the retrofitted tank from corrosion. Newly constructed tanks are typically internally coated with a protective barrier in between the fluid and the carbon steel wall. This is performed in a controlled environment. Internally coating a tank in the field is much more difficult and commonly results in imperfections that accelerate corrosion. An alternative option is placing sacrificial anodes in the tanks, but this requires constant maintenance. Production decline rarely makes replacing/retrofitting tanks a viable option.

Thief hatch design changes have improved resulting in better seals to prevent tank emissions to atmosphere and better relieving control (closer to tank rating).

There is some recent technology that allows for operators to monitor the open/close status of thief hatches using magnetic switches. However, at this point in its development, reliability is unproven. There is also an economic burden given that it would require installation on every thief hatch. It would also require communications for remote monitoring.

Operators may consider the type of dump valve and the use and its intended service. Snap acting valves and throttling valves can be more appropriate in different settings, and an evaluation of the most appropriate device for the setting can improve dump valve performance. Advancements in communication technology (i.e. internet, email, etc.) have made it easier to right-size valves.

The most significant evolution in upstream has been in the ability to remotely monitor and control processes. Programmable Logic Control (PLC), Supervisory Control and Data Acquisition (SCADA) systems, etc. allow operators to monitor, trend, and control different aspects of their process that are enabled through the use of instrumentation (e.g. Pressure Transmitters, Flow Transmitters, Level Switches, Level Transmitters, etc.). While SCADA is installed for operational purposes, analysis of that data and integration of more SCADA over time can result in lower emissions as facilities are run more efficiently. PLC and SCADA systems require both instrumentation and communication equipment. This poses an economic burden and may not be scalable to smaller operators or many existing locations.

## 2. INFORMATION ON EQUIPMENT OR PROCESS COSTS, SOURCES OF METHANE EMISSIONS, AND REDUCTION OR CONTROL OPTIONS

Identify the capital and operating costs for the equipment or the process. Identify how methane is emitted or could be leaked into the air. Please **prioritize** the list to identify first the largest source of methane from the process or equipment and where there is **potential** for the greatest reduction of methane emissions. Note any differences expected for differing well types, industry sector, or basin location.

### Sources of Methane:

Provide an overview of the sources of methane from this equipment or process:

Separator and tank/process flash gas are primarily composed of methane, VOCs, and small amounts of BTEX. In addition to flash emissions previously discussed, storage tanks also have the potential to create working and breathing (or standing) emissions depending upon how tank vents are handled. Working emissions are generated when liquid is added to or removed from the tanks. Turbulence in the liquid may cause vapor to be released from the oil. Breathing or standing emissions occur during the normal expansion and contraction of the tank vapor and is dependent on changes in the ambient temperature.

The potential methane emission sources for processing and storage vessels are thief hatches (opening in the top of a tank, which provide access for a thief or level measuring device and also often functions as a pressure/vacuum relief device), pressure vacuum relief valves (PVRV), other safety relief devices (PRV), combustion equipment associated with heater treaters, malfunctioning control equipment such as level controllers/dump valves (fugitive emissions which will be covered in the leak detection paper) and vents. If operating pressures in separators or storage tanks exceed the pressure relief device set point, the device will vent to prevent vessel over-pressure. For thief hatches, worn or dirty gaskets may also prevent a tight seal from forming. Any methane emissions from combustion equipment (e.g. heater treaters, line heaters, and vapor combustion devices/flares) would be very small as combustion efficiency greater than 98% is expected.

In general, emissions in this category come from #2 and #19 in the flow chart on page 2.

## NM METHANE METRIC TONNES FROM TANKS



[https://d3n8a8pro7vhmx.cloudfront.net/nmoga/pages/1008/attachments/original/1563831145/NMOGA\\_MethaneMitigationRoadmap.pdf](https://d3n8a8pro7vhmx.cloudfront.net/nmoga/pages/1008/attachments/original/1563831145/NMOGA_MethaneMitigationRoadmap.pdf)

The emissions reported to subpart W include flashing, breathing and working losses, but do not include emissions from tank thief hatches or other system/VRU malfunctions.

● Pneumatics ● Unloading Equipment ● Liquids ● Tanks ● Other

**2017 NM O&G METHANE EMISSION MT'S**

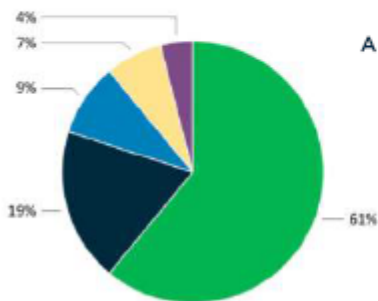

**2017 SAN JUAN NM O&G METHANE EMISSION MT'S**

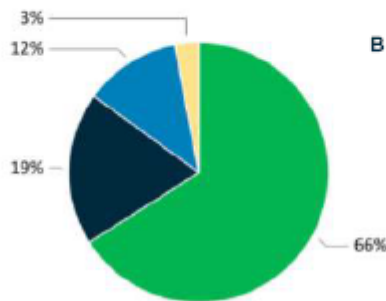

**2017 PERMIAN NM O&G METHANE EMISSION MT'S**

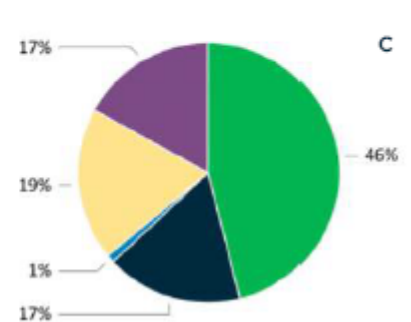

Per Synthesis data<sup>144</sup>, as reported in the April 11<sup>th</sup>, 2019 EDF report<sup>145</sup> and associated data platform<sup>146</sup>, EDF estimates about 23,000 metric tons of methane from tank vents in New Mexico in 2017 (55% from produced water tanks and 45% from oil/condensate tanks). Additionally, EDF estimates about 650,000 metric tons of methane from all sources that result from abnormal process conditions in NM, <https://www.edf.org/energy/explore-new-mexicos-oil-and-gas-pollution> There are many observations by researchers and authors of measurement studies which suggest that storage tanks are the likely release point of most large emissions and many of these may be due to abnormal conditions such as tank control system failures and upstream malfunctions such as stuck separator dump valves. "Anecdotal data" is based on or consisting of reports or observations of usually unscientific observers. <https://www.merriam-webster.com/dictionary/anecdotal>

### **Control System Failures**

Tank control system failures can also lead to methane emissions. Common causes of system failure include the following:

- Design Flaws
  - VRUs undersized
  - Separators undersized / dumping very frequently
  - Separator dump valve leakage
  - Liquid pooling
- Mechanical Failures
  - Thief hatch mechanical failure (gasket failure, weak or defective sealing mechanisms, etc.)
  - Pilot flame fuel supply and igniter failures
  - Incomplete combustion
- Operational Failures / Errors
  - Thief hatches open
  - Other issues – intentional bypass, flares unlit
- Leaks in the system

### **Truck Loading**

Truck loading is another source of methane emissions. As discussed in a previous section, pipeline is the preferred method of takeaway, but is only feasible if 1) a pipeline is available, 2) power is available for pumps, and 3) it is economically justifiable. If a pipeline is not available, truck hauling is the only viable option. Loading occurs at atmospheric pressure (after fluid pressure reduction), and losses occur as vapors in empty tank trucks are displaced to the atmosphere by the liquid being loaded into the tanks. These vapors are a composite of 1) vapors formed in the empty tank by evaporation of residual product from previous loads, 2) vapors transferred to the tank in vapor balance systems as product is being unloaded, and 3) vapors generated in the tank as new product is being loaded. Utilizing a vapor balance system can reduce emissions, however, by returning these vapors to the storage vessels.

There are three state jurisdictions currently regulating truck loading, including Wyoming, Utah, and Pennsylvania. Specifically, in Wyoming, loading emissions containing greater than or equal to 6 tpy VOC and HAP emissions must be controlled. Operators of new facilities must utilize a vapor collection system or equivalent device for the truck loading operation that captures a minimum of 70% of the truck loading vapors, and to route the vapors to device with a destruction efficiency of 98%.<sup>147</sup> In Utah, tanker trucks used for intermediate hydrocarbon liquid or produced water must be loaded using bottom filling or a submerged fill pipe. Operators must control VOC emissions during truck

<sup>144</sup> Alvarez et al., Assessment of Methane Emissions from the U.S. Oil and Gas Supply Chain, 361 SCIENCE, 186–188 (2018) <http://science.sciencemag.org/content/361/6398/186>

<sup>145</sup> <https://www.edf.org/energy/explore-new-mexicos-oil-and-gas-pollution>

<sup>146</sup> <https://www.edf.org/nm-oil-gas/>

<sup>147</sup> WDEQ Permitting Guidance, at 11.

loading operations at all times using a vapor capture line. The vapor capture line must be connected from the tanker truck to a control device or process, resulting in a minimum 95% VOC destruction efficiency.<sup>148</sup> In Pennsylvania, since August 10, 2013, in accordance with Category 38 of the Air Quality Permit Exemptions document tanker truck load out operations are required to be equipped with controls achieving VOC, and HAP emissions reductions of 95% or greater unless their uncontrolled VOC, single HAP, and total HAP emissions are below the control thresholds of 2.7 tpy, 0.5 tpy, and 1.0 tpy, respectively. Per GP-5 and GP-5A, tanker truck loadout operations that take liquids from storage vessels with emissions above the control thresholds are required to use a vapor balancing system and ensure each truck used to unload liquids has passed an annual leak test.<sup>149</sup> As shown by the initial EIA, these measures will be cost effective.<sup>150</sup>

#### New Wells:

Surface facility processing and storage vessels are used in both new and existing facilities. On site storage capacity is determined based on expected production of oil and water. NSPS OOOOa requires that new, modified, or reconstructed storage tanks which emit greater than 6 tons per year of VOC reduce emissions by 95% or greater within 60 days after startup. NSPS OOOOa allows storage tanks whose emissions decrease below 4 tpy of VOC for at least 12 consecutive months to operate uncontrolled. EPA provides for removal of controls at 4 tpy as it is no longer cost effective.

#### Existing Wells:

Surface facility processing and storage vessels are used in both new and existing facilities. On site storage vessels capacity is determined based on expected production of oil and water. As well production rates decline, storage needs may decrease allowing for isolation or removal of some tanks.

Older existing storage tanks may not be equipped with a vapor collection and combustion device to control tank emissions depending on actual production and permitting thresholds. In some situations, it may be technically infeasible to install a control device as there may not be enough gas (volume and pressure) to safely operate a control device.

#### How are the emissions calculated for this equipment or process?

Emissions from storage vessels are calculated as part of an NMED air permit application, NMED emissions inventories, and EPA GHG reporting. Flash emissions are dependent on a multitude of factors, including oil throughput, oil composition, API gravity, and separator/heater treater temperature and pressure. Due to the complex nature of flash emissions, they are typically estimated using a process simulator such as ProMax and HYSIS using equations of state or by using transient programs such as OLGA, HYSIS DYNAMIC, LedafLOW. Storage tank working and breathing losses may be calculated using AP-42 equations or software built using AP-42 equations (e.g. EPA TANKS, E&P Tanks). Manufacturer's data and state/federal guidance are utilized to determine the control efficiencies of the various types of controls (e.g. VRUs, combustion devices). Typically, multiple storage vessels are connected to a single combustion device through a common header system.

For EPA GHGRP, Basins (Permian and SJ) are broken out into Production and Gathering & Boosting segments. For emission calculation purposes, the total number of oil storage tanks and associated vent management systems (VRT, VCU, uncontrolled) per location are considered along with the volume of oil produced annually utilizing storage at the

<sup>148</sup> EDF\_PHS\_EX-080, Utah Ann. Code § 307-504-4

<sup>149</sup> Pennsylvania BAQ-GPA/GP-5, § F(1)(a); Pennsylvania BAQ-GPA/GP-5A, § F(1)(a).

<sup>150</sup> Initial EIA, at 29-30.

corresponding site to calculate a methane emission estimate for each facility. Estimated emissions are reported for each segment per county. For pressure relief devices, leaks found during LDAR surveys are reported and quantified/estimated in GHGRP as well using EPA approved emission factors for the type of equipment (e.g. valve) and the type of service the equipment is in (e.g. light oil).

Note that not all storage tank emissions are reported under the Subpart W GHGRP due to the reporting threshold. Additionally, calculated tank emissions figures do not include abnormal process conditions, such as stuck dump valves or open thief hatches, which are responsible for large amounts of methane and VOC emissions.

GHGRP – Calculation tool link:

<https://ccdsupport.com/confluence/display/help/Optional+Calculation+Spreadsheet+Instructions>

NMED Air Emission Calculation Tool (AECT) link: <https://www.env.nm.gov/air-quality/air-emissions-calculation-tool-aect/>

#### What data is available to quantify emissions/waste for this equipment or process?

The US EPA publishes most of the emission information and activity data that it receives as part of the US GHG Reporting Program annually ([https://ghgdata.epa.gov/ghgp/main.do?site\\_preference=normal#](https://ghgdata.epa.gov/ghgp/main.do?site_preference=normal#)). By March 31<sup>st</sup> of each year, operators upload their emission information to the EPA website for the previous year (i.e. 2018 emission information was reported in March 2019), EPA undertakes a quality assurance process, and uploads the information in October to a publicly accessible website. Care should be taken in estimating emissions from this inventory for New Mexico since both the Permian and San Juan Basins span multiple states and are challenging to separate emissions between states for all source categories.

<https://www.epa.gov/ghgreporting>

NMED currently conducts annual emission inventories for permitted major sources. NMED will also be conducting an emission inventory for calendar year 2020 which will include emissions from all sources with an air quality construction permit (including general construction permits such as the GCP-O&G) or notice of intent (NOI). The emissions inventory will be reported to NMED by April 1, 2021.

In addition to the above-mentioned inventories, companies are required to report emissions in excess of the quantity, rate, opacity, or concentration specified by an air quality regulation or permit condition. Therefore, emissions in excess of a limit or rate established by an air permit (including the GCP-O&G, NSR, or other air permit) are reported to NMED through excess emission reports per 20.2.7 NMAC.

Various studies and information indicate tank emissions are higher than estimated and likely account for many of the largest emissions releases. Relevant studies include the following:

EDF Synthesis study: Alvarez et al., Assessment of Methane Emissions from the U.S. Oil and Gas Supply Chain, 361 SCIENCE, 186–188 (2018) <http://science.sciencemag.org/content/361/6398/186>

Lyon, D.R., Alvarez, R.A., Zavala-Araiza, D., Brandt, A.R., Jackson, R.B. and Hamburg, S.P., 2016. Aerial surveys of elevated hydrocarbon emissions from oil and gas production sites. Environmental science & technology, 50(9), pp.4877-4886, <https://pubs.acs.org/doi/abs/10.1021/acs.est.6b00705>

US EPA Compliance Alert: EPA Observes Air Emissions from Controlled Storage Vessels at Onshore Oil and Natural Gas Production Facilities, September 2015, available at <https://www.epa.gov/sites/production/files/2015-09/documents/oilgascompliancealert.pdf>

Englander, J.G., et al, Aerial Interyear Comparison and Quantification of Methane Emissions Persistence in the Bakken Formation of North Dakota, USA, *Environ. Sci. Technol.* 201852158947-8953, available at <https://pubs.acs.org/doi/abs/10.1021/acs.est.8b01665>

Clean Air Task Force (CATF) analysis of emissions from controlled tank systems in the helicopter study is available here: [https://www.epa.gov/sites/production/files/2017-11/documents/5\\_catf\\_tank\\_presentation\\_for\\_inventory\\_workshop\\_final.pdf](https://www.epa.gov/sites/production/files/2017-11/documents/5_catf_tank_presentation_for_inventory_workshop_final.pdf)

#### What are the data gaps in quantifying emissions/waste for this equipment?

There are gaps in quantifying emissions at sites that do not have remote monitoring or control, and it may not be reasonable to retrofit these existing facilities.

There are also gaps in direct measurement of emissions from storage tanks regardless of whether they are destroyed or vented. In low-pressure conditions, such as storage tank vent headers, technical feasibility issues exist with measurement of these low flow, low energy flows. To improve accuracy at low volumes sent to a flare, a smaller orifice size is required but such a restriction in the flare piping introduces intolerable safety concerns when flow increases. Furthermore, an orifice meter will restrict the line to the flare such that when large volumes are flared for emergency purposes, it will result in an explosion. Other meter options such as ultrasonic or thermal mass can be more costly, and depending on technology, can be very sensitive to operating and ambient conditions at low flow conditions (e.g., thermal mass meter). In most situations, the only economically feasible form of measurement is using a thermal mass meter, which is too dependent on calibration to be considered reliably accurate. In lieu of direct measurement, process modeling or metering downstream of the compressors is a more viable option to quantify emissions.

### Economic Description of the Process or Equipment:

#### What is the per unit cost of the equipment or the costs associated with the process?

Costs vary widely based upon design, materials of construction, and capacity. Because the operation of VRUs is not always economical or feasible, VRUs are often leased rather than purchased by an operator.

#### What are the annualized operating costs for the equipment or costs associated with the process?

Costs vary widely based capacity and service conditions. VRUs are often leased and operators will be charged as long as the VRU is on site. There typically comes a point at which the operation of the VRU is no longer economic due to low volumes of gas being recovered or low gas prices.

Note that a VRU can be used to capture emissions streams in addition to tank emissions, such as dehydrators and pneumatics. This makes the economics of the VRU more attractive to an operator.

#### If the equipment or process is powered, what are the costs?

Generally, the processing vessels and tanks are not powered. The control equipment (controllers, actuators, process indicators) for the vessels consume power. The exception is heater treaters, which are generally use field gas to generate heat through combustion. VRUs require a powered driver for the compressor (electric or natural gas engine).



The availability of reliable and adequate voltage electrical grid power is a determining factor on control strategy. In addition to cost of power, reliability is an important consideration for control devices as interruption will result in controllers going to a fail-safe condition. If an electric VRU is on site and power fails, gas will go to flare or potentially be vented from tank pressure relief devices.

What are the maintenance and repair costs for existing or new equipment?

Costs vary widely based upon size, age, and configuration.

## Existing Reduction Strategies:

How has industry reduced emissions/waste from this equipment or process historically?

Pursuant to [20.2.72 NMAC](#) and [20.2.74 NMAC](#), oil and gas companies that wish to build or modify facilities must obtain an air quality permit from NMED prior to construction based on the potential air emission rate or potential to emit (PER or PTE) of the entire facility. Air permits are required for any facility with potential emissions greater than 10 pounds per hour or 25 tons per year of pollutants with a national or state ambient air quality standard. The NMED has issued several General Construction Permits (GCP) specifically for the oil and gas industry. GCP-Oil & Gas (issued 4/27/2018) may be obtained for a variety of oil and gas facilities, and GCP-6 (issued 1/14/2014) authorizes voluntary controls for storage vessels. Both permits are relevant to current emissions concerns and aim to reduce emissions.

Smaller well pad facilities may qualify to operate under a Notice of Intent (NOI) registration if potential emissions are more than 10 tons per year of any regulated pollutant, but less than the threshold required to obtain a minor construction permit such as the GCP-Oil & Gas.

The rapid growth in crude oil production in southeast New Mexico began in 2011, which corresponds with the initial NSPS OOOO applicability date. As such, many existing storage vessels are currently subject to controls under NSPS OOOO/OOOOa. In New Mexico, the enforceable state program (GCP-Oil & Gas) allows operators to account for emissions reductions processes when calculating potential emission rate (PER) to determine NSPS OOOO/OOOOa applicability for new and modified storage vessels. EPA expressly allows for operators to account for enforceable limitations under state programs to prevent operators from being subject to duplicative requirements under state and federal law. To avoid duplication, storage vessels should only be required to comply with either NSPS OOOO/OOOOa or the state program, not both. It is estimated that more than 59% of oil production in New Mexico is either subject to the control requirements of NSPS OOOO/OOOOa, subject to the control requirements of the enforceable state program, or utilizes process equipment which results in emission rates that allow for registration under the NOI.

According to DrillingInfo<sup>151</sup> data, EDF estimates that **only 15% of well sites** in New Mexico are new/modified after August 23, 2011 and are therefore subject to the NSPS standards. As such, the remaining 85% of existing sources (the large majority of facilities) are not currently subject to OOOOa tank standards unless there have been modifications to the tanks

151

[https://www.enverus.com/?utm\\_source=google&utm\\_medium=cpc&utm\\_term=drillinginfo&utm\\_campaign=DrillingInfo\\_Brand&utm\\_adgroup=DI\\_Generic\\_Brand\\_Match&bt=341635638623&bm=e&bn=g&bk=drillinginfo&gclid=CjwKCAiA\\_MPuBRB5EiwAHHTvMUwsPpq8U3RAVQxq9gYqyMw74CrIsimx5htzAbI\\_jZ\\_kJBVUT4Jh7BoCUF8QAvD\\_BwE?utm\\_source=google&utm\\_medium=cpc&utm\\_term=drillinginfo&utm\\_campaign=DrillingInfo\\_Brand&utm\\_adgroup=DI\\_Generic\\_Brand\\_Match&bt=341635638623&bm=e&bn=g&bk=drillinginfo&gclid=CjwKCAiA\\_MPuBRB5EiwAHHTvMUwsPpq8U3RAVQxq9gYqyMw74CrIsimx5htzAbI\\_jZ\\_kJBVUT4Jh7BoCUF8QAvD\\_BwE](https://www.enverus.com/?utm_source=google&utm_medium=cpc&utm_term=drillinginfo&utm_campaign=DrillingInfo_Brand&utm_adgroup=DI_Generic_Brand_Match&bt=341635638623&bm=e&bn=g&bk=drillinginfo&gclid=CjwKCAiA_MPuBRB5EiwAHHTvMUwsPpq8U3RAVQxq9gYqyMw74CrIsimx5htzAbI_jZ_kJBVUT4Jh7BoCUF8QAvD_BwE?utm_source=google&utm_medium=cpc&utm_term=drillinginfo&utm_campaign=DrillingInfo_Brand&utm_adgroup=DI_Generic_Brand_Match&bt=341635638623&bm=e&bn=g&bk=drillinginfo&gclid=CjwKCAiA_MPuBRB5EiwAHHTvMUwsPpq8U3RAVQxq9gYqyMw74CrIsimx5htzAbI_jZ_kJBVUT4Jh7BoCUF8QAvD_BwE)

at the site. Using the same DrillingInfo data, EDF calculates that the existing facilities are responsible for 87% of total cumulative production since August 2011 in New Mexico, illustrating that the majority of wells and production are not subject to the NSPS.

Tank modifications, such as adding a new oil and gas well's production to the tank battery, tank modifications, etc. result in the tank becoming subject to OOOOa regulations. These newer wells (15%) added 129 million barrels of annual oil production (180% increase) over the time period, bringing total current annual oil production to 200 million barrels. The remaining 85% of well sites account for 71 million barrels, or 1/3, of current annual oil production.

(<http://www.emnrd.state.nm.us/ADMIN/publications.html>)

Tank replacement or retrofits of old storage tanks have been employed to allow tank emissions to be routed to a control device when needed on a case-by-case. Replacement or retrofits of old tanks are usually required because many existing storage vessels at older facilities were not designed to employ vent control devices and are subject to new emission reduction needs. The additional back pressure on the tank from an improperly designed controlled vent header may pose a safety risk by compromising tank integrity from over-pressurization. However, the economics and technical feasibility of this option is predicated on various factors. Costs, estimated useful equipment life, product value, production type and volume (well life), and geographic issues and logistical constraints are all factors in the determination. Additionally, in the San Juan Basin, tank retrofit is not a technically feasible option for the open-top tanks that are commonly used.

Storage tank equipment control requirements for existing facilities, not already subject to NSPS OOOO/OOOOa, should be based on appropriate thresholds (e.g., low production facilities that cannot support new technology controls). Existing source engineered retrofits are more costly than controls on a new source. The throughput impacts the ability of the control equipment to function effectively, so for existing storage tanks, the control threshold should be even higher due to the additional cost to retrofit the equipment.

Retrofit engineering analysis requires collection of facility and production data, an engineering review of the entire system (including retrofit or tank replacement), and economic considerations.

Facility Data/Information Collection (inlet to outlet) needs:

1. Vessel/tank(s)/piping/valves/connections inspection (integrity), maintenance, and operational condition
  - a. Tanks
    - i. Roof and sides (shell)
    - ii. Foundation
    - iii. As-builts including controls/automation
    - iv. Internal inspection
    - v. Specification sheet
  - b. Vessels (separator) /Piping
    - i. Pressurized fluids analysis
    - ii. Shell vessel inspection (welds, thickness, penetrations, mechanical function)
    - iii. As-built (piping size, connections, valves), metallurgy, and automation
    - iv. Specification sheet
  - c. Mechanical Integrity (MI)
    - i. Non-destructive examination (NDE)
    - ii. Metal thickness
    - iii. Brittle fracture
    - iv. Joints (welds)
    - v. Penetrations
  - d. Maintenance
    - i. Inspections records
    - ii. Equipment maintenance records (vessels, tanks, piping, PRVs, Thief Hatches)

- iii. Releases (spills, LDAR, etc.)
- e. Operations
  - i. Placement of equipment (spacing)
  - ii. Suitability for Service
  - iii. Automation
  - iv. Air permit/Regulatory requirements
  - v. Marginal production facility / GIS-remote location
  - vi. Operational changes over time
- 2. Oil/Gas throughput, pressure, temperature, liquids analysis, and extended gas analysis (VOCs, methane)
- 3. Power source (electricity, generator, solar)
- 4. Oil and gas pipeline/infrastructure (e.g., collection system, LACT, meter, etc.) in place

Engineering Review (retrofit versus remove/replace separators/storage vessels):

1. Process model/simulations e.g., Promax, Hysys, Pipesim
2. Process results ... system flowrate, pressure, equipment specs
3. Compare process results to existing equipment/facility data
4. Process optimization
  - a. Vessels – (e.g., pressure, corrosion (internal), wall thickness)
  - b. Tanks – (e.g., pressure, corrosion (internal, top), wall thickness, compatible materials)
  - c. Piping/Valves/Connections (e.g., size, corrosion, wall thickness, compatible materials)
5. Tanks/vessels out of service to complete the retrofit (PVRV/thief hatch condition).

Economic Considerations -- Technical Feasibility / Costs / Remaining Useful Life of Equipment:

Based on the above engineering analysis, operators can then decide the most feasible methane control based on technical feasibility, costs (e.g., rate-of-return/return of capital/or payback standpoint), and remaining useful life of equipment (e.g., mechanical integrity and replacement costs). In many cases, the production rate of older stripper<sup>1</sup> oil and gas wells will not support facility retrofits. In addition, due to the low well production rates the emissions from these tanks may be low resulting in a high cost/benefit ratio.

There are 57,868 oil and gas wells in the state of New Mexico of which 11,670 oil wells produce 10 BOPD or less, and average 2.5 BOPD per well. There are 26,282 natural gas wells that average 23 mcf per well. Combined, these oil and natural gas stripper wells make up 66% of all wells in New Mexico and produce 12.4 million barrels of oil and 225 billion cubic feet of natural gas annually. ([https://www.eia.gov/petroleum/wells/pdf/full\\_report.pdf](https://www.eia.gov/petroleum/wells/pdf/full_report.pdf))

By their very nature of marginal producing rates this class of well is cost sensitive. Frequently, these wells and facilities may be shut in or plugged and abandoned rather than retrofitted resulting in underground waste from unrecovered hydrocarbons. The reservoirs that stripper wells access are not necessarily depleted, in many cases they still hold two thirds of its potential value, however due to the low operating margin of a stripper well they are at risk of premature abandonment, leaving large quantities of oil and gas reserves behind.

(<http://iogcc.ok.gov/Websites/iogcc/images/MarginalWell/MarginalWell-2015.pdf>)

Any storage vessels not currently subject to OOOO/OOOOa, which are replaced due to state regulations or due to reaching the end of useful life, will be subject to OOOO/OOOOa, which would provide additional emission reductions. At very low levels of gas, in order to run a combustion device, operators would need to bring out supplemental fuel.

<sup>1</sup>Stripper Well: An oil well that produces 10 BOPD or less, and a gas well that produces 60 Mcfd or less as defined by the Interstate Oil & Gas Compact Commission.

Remaining useful like of equipment include wells and tank settings. For discussion purposes:

- Technical Feasibility: For retrofitting a tank setting, the operator must have adequate Q (including production decline), P, and tank integrity to address delta P operations with a control device to be technically feasible. If the tank integrity is in question, then tank modifications or replacement (along with tank cleanout) is required.
- Costs: Cost comes in several different ways, one being monthly lease operating expense (LOE), and others coming as deductions from product income streams such as lease burdens (State & Federal royalty, ORRI, production payments, etc.), production taxes, and product price deductions for items such as gathering and transportation, dehydration, processing, and compression.
- Cash flow: Revenue minus lease burden (expenses, taxes, etc.).
- Cash Flow Deferral – Time when well and facility operates at a loss.
- Useful life of a well/facility: Generally, if the cash flow deferral is greater than 3 years, the well/facility may be considered no more useful resulting in waste of resources in the oil and gas reservoir.

**STRIPPER OR MARGINAL WELL CASE:**

- ▶ Avg stripper (also referred to as marginal) oil well 2.5 BOPD, average stripper gas well 23 MCFD
- ▶ Monthly Revenue at \$50/BO and \$2/MCF is \$3,800 and \$1,400 respectively.
- ▶ Monthly Income (deducting lease burden and taxes) \$2,800 and \$1,030 respectively.
- ▶ Monthly Cash Flow (deducting LOE) \$1,200 and \$530 respectively.
- ▶ This case for a stripper well operating near the current product pricing level above illustrates the annual cash flow to be \$14,400 for oil and \$6,360 for gas. From these cash flow numbers, it can be easily seen that stripper (marginal) wells are extremely cost sensitive and any one time expense of \$14,400 for a stripper oil well or \$6,360 for a stripper gas well would render the well uneconomic for an entire year. An annually reoccurring expense of the same magnitude would render the well permanently uneconomic to operate, production would cease, and the well would be plugged and abandoned (P&A). This case also illustrates even fractional increases in operating expense have a significant impact on profitability and subsequently a significant impact on the companies that operate stripper or marginal wells.

As noted previously on page 7, connection of a tank vent header to a VRU requires a more complex design/installation to manage the potential failure consequences. The potential to draw tank pressure down below 0 osig in the condition of 1) inadequate flash gas from the influent, 2) no/inadequate blanket gas system, 3) inadequate/malfunctioning PVRV can result in tank failure/collapse. Blanket gas systems, if present, are normally installed on newer and/or larger facilities due to cost and complexity. Without blanket gas systems, air/oxygen can be drawn into the tanks through the PVRV producing a potentially combustible mixture and/or gas that does not meet midstream specifications. The mixture imposes a safety risk and also may result in curtailment of the gas sales line which leads to flaring.

**New Wells:**

In newer high producing wells, there are more opportunities to control emissions via vapor recovery. Newer sources are also covered by NSPS OOOO/OOOOa.

**Existing Wells:**

N/A

How have the emission/waste reductions been measured?

NMED emissions calculations for the permitting process and process simulation prior to the development of a facility to ensure emissions are in compliance with required permitted limits. Additionally, tank methane and GHG emissions are reported under the GHG Reporting Rule.

How have states and the federal government reduced emissions/waste from this equipment or process historically?

In addition, please identify voluntary reductions achieved whether or not they were in response to a regulatory action/requirement.

The NMED General Construction Permit (GCP) requires controls reducing VOCs and HAPs, which also reduce methane. Moreover, the NMED permits require conditions to ensure that the controls remain effective. For example, the GCP Oil and Gas requires inspection of controls, periodic gas sampling of the gas routed to the separator/tanks, and other requirements. The requirements (conditions) are intended to ensure the emissions from the tanks remain below permit allowances.

CO: <https://www.colorado.gov/pacific/cdphe/air-oilandgas-storage-tank-guidelines>

EPA: <https://www.epa.gov/sites/production/files/2015-09/documents/oilgascompliancealert.pdf>

In Colorado, state rules require 95% control efficiency of hydrocarbons from individual new storage tanks with the PTE 6 tpy of VOCs.<sup>152</sup> Colorado is also proposing new rules for storage tanks which would lower the threshold at which an owner or operator must control storage tank emissions on a state-wide basis from 6 tpy to 2 tpy.<sup>153</sup> In addition, Colorado is proposing operators install automatic tank gauging on storage tanks to monitor the liquid level.<sup>154</sup> Finally, Colorado is proposing operators of storage tanks with uncontrolled actual VOC emissions greater than or equal to 2 tpy must control emissions from the loadout of hydrocarbon liquids from storage tanks to transport vehicles by using submerged fill and a vapor collection and return system and/or air pollution control equipment.<sup>155</sup>

Colorado's proposed 2-tpy threshold for installing storage tank controls is not supported by the cost data and will not result in cost-effective emission reductions. Of perhaps most importance, Colorado's economic analysis utilizes a 15 year period over which to annualize the costs associated with hydrocarbon liquid and produced water tanks. With respect to at least a subset of these storage tanks, historic evidence and current plans demonstrate that those tanks will not be in existence within 15 years and thus annualizing the cost out over the life of the equipment – as opposed to over the remaining life of the well is inappropriate. Colorado also incorrectly assumes that the emissions reductions remain steady year over year. The reality is that a number of wells operating today within the 2 to 4 tpy framework, will not be operational within five years. Even for those low-emitting storage tanks that are not expected to be plugged and abandoned in the next several years, the production is continuing to decline and thus, so are the emissions – limiting the value of emission reduced each year. Of significance as well, cost-effectiveness is not the only metric that is of importance – and frankly is not the metric utilized by operators. Rather, operators evaluate the production from the well, the operating costs of the wells, the continued life of the well, and the taxes and other expenses of the wells in determining its path

<sup>152</sup> Colorado Air Quality Control Commission, 5 C.C.R. 1001-9, CO Reg. 7 §XVII.C.1.b. (Feb. 24, 2014). Available at <https://drive.google.com/file/d/168v7vMsFJtS7D8BWInMbaXWA6uZUlyj8/view>

<sup>153</sup> Colorado Air Quality Control Commission, proposed revisions to Regulation 7, available at <https://drive.google.com/drive/folders/14ftv4C0Tzl79to4c2tVuLDKucksk5uaB>

<sup>154</sup> *Id.*

<sup>155</sup> *Id.*

forward with respect to any given well. Expenses such as those proposed in in Colorado will come at the outset and at considerable cost. As a result, operators may be forced to evaluate if they can continue operating wells and whether there remains sufficient value in a particular well to justify the costs of compliance (and for how long). Ignoring these considerations is not appropriate.

Colorado has proposed to require operators of storage tanks with 2 tpy of VOCs to use submerged fill and either a vapor collection and return system, air pollution control equipment, or both to reduce tank loadout emissions.<sup>156</sup>

[https://doc-0o-68-docs.googleusercontent.com/docs/securesc/ha0ro937gcuc717deffksulhg5h7mbp1/v7vu3oupcqapualargdbcm4uedb202ac/157359600000/09887998073533830170/\\*1ot2dCFpgp18S8cqQWMHIZGQ\\_uz0VYKHy?e=download](https://doc-0o-68-docs.googleusercontent.com/docs/securesc/ha0ro937gcuc717deffksulhg5h7mbp1/v7vu3oupcqapualargdbcm4uedb202ac/157359600000/09887998073533830170/*1ot2dCFpgp18S8cqQWMHIZGQ_uz0VYKHy?e=download)

Wyoming regulations specific to the Upper Green River Basin require new and existing tanks control flash emissions by at least 98%. Removal of flashing emissions control devices is allowed after 1 year if VOC flashing emissions have declined to less than, and are reasonably expected to remain below, 4 tpy. Statewide, Wyoming requires 98% control for tanks with 6 tpy of VOCs.<sup>157</sup> The Wyoming threshold is applied to the cumulative emissions from all tanks located at a well production facility. Accordingly, if there is more than one manifolded storage vessel onsite, operators must apply controls if the sum of all emissions from both manifolded vessels are 4 tons per year or greater.

Utah similarly requires 95% control of storage tank emissions if emissions are at least 4 tpy of VOCs.<sup>158</sup> Utah, similarly, requires operators to aggregate tanks and glycol dehydrators emissions, in order to calculate emissions for purposes of determining whether controls are required.<sup>159</sup>

In California, tanks with 10 metric tons of CH<sub>4</sub> or more must route emissions to a vapor collection system. Combustion using a low-NO<sub>x</sub> flare is only allowed if capture is demonstrated to be infeasible.<sup>160</sup> Pennsylvania general permit and exemption requirements mandate 95% control if emissions are 200 tpy of CH<sub>4</sub>, or 2.7 tpy of VOC.<sup>161</sup>

Mexico adopted the same 10 metric tons of CH<sub>4</sub> threshold as CARB, recently, in its adoption of country-wide methane rules.<sup>162</sup> Mexico also requires operators capture emissions and route to vapor recovery unless it is infeasible to do so.<sup>163</sup>

---

<sup>156</sup> Colorado Air Quality Control Commission, proposed revisions to Regulation 7, available at <https://drive.google.com/drive/folders/14fvt4C0Tzl79to4c2tVuLDKucksk5uaB>

<sup>157</sup> WDEQ, Oil and Gas Production Facilities Ch. 6, Section 2 Permitting Guidance for the UGRB (2016), available at <http://deq.wyoming.gov/media/attachments/Air%20Quality/New%20Source%20Review/Guidance%20Documents/5-12-2016%20Oil%20and%20Gas%20Guidance.pdf>

<sup>158</sup> U.A.C. § 307-506.

<sup>159</sup> U.A.C. § 307-506.

<sup>160</sup> 17 C.C.R. Section 95668(a) (March 24, 2006), available at <https://www.arb.ca.gov/cc/oil-gas/Oil%20and%20Gas%20Appx%20A%20Regulation%20Text.pdf>

<sup>161</sup> Department of Environmental Protection, Air Quality Permit Exemption 38, available at <http://www.elibrary.dep.state.pa.us/dsweb/Get/Document-96215/275-2101-003.pdf>

<sup>162</sup> SEMARNAT, ASEA, Secretaria de Medio Ambiente y Recursos Naturales, Title III, Ch. VI, Article 49, [http://www.dof.gob.mx/nota\\_detalle.php?codigo=5543033&fecha=06/11/2018](http://www.dof.gob.mx/nota_detalle.php?codigo=5543033&fecha=06/11/2018).

<sup>163</sup> Id., Article 50.

Pennsylvania has required new storage tanks located at unconventional well sites to limit VOC emissions to 2.7 tons per year since 2013.<sup>164</sup> Recently the state retained this requirement in its general permits, GP-5 and GP-5A. GP-5 applies to midstream compression, gas processing, and gas transmission facilities. GP-5A applies to new or modified unconventional natural gas well site operations and remote pigging stations.<sup>165</sup> The Pennsylvania Department of Environmental Protection has proposed to require existing storage tanks installed at unconventional well sites on or after August 10, 2013, with potential to emit 2.7 tpy of VOCs to control emissions by 95% as part of its implementation of the EPA Control Techniques Guidelines.<sup>166</sup>

Canadian operators are subject to a facility venting limit of 15,000 standard cubic meters per year. Rules also require operators to reduce venting by 95% if produced and received gas amounts to 60,000 cubic meters per year (PTE threshold).<sup>167</sup> In British Columbia, new tanks which begin operations after Jan. 1, 2022, are subject to an emissions limit of 1,250 m3 per month. Existing tanks that begin operations before Jan. 1, 2022, are subject to an emissions limit of 9,000 m3 per month. Operators must retain records of emissions from uncontrolled storage tanks on a monthly basis.<sup>168</sup>

Various jurisdictions require operators control vapors when unloading liquids from storage tanks. Specifically, in Wyoming, loading emissions containing greater than or equal to 6 tpy VOC and HAP emissions must be controlled. Operators of new facilities must utilize a vapor collection system or equivalent device for the truck loading operation that captures a minimum of 70% of the truck loading vapors, and to route the vapors to device with a destruction efficiency of 98%.<sup>169</sup> In Utah, tanker trucks used for intermediate hydrocarbon liquid or produced water must be loaded using bottom filling or a submerged fill pipe. Operators must control VOC emissions during truck loading operations at all times using a vapor capture line. The vapor capture line must be connected from the tanker truck to a control device or process, resulting in a minimum 95% VOC destruction efficiency.<sup>170</sup> In Pennsylvania, since August 10, 2013, in accordance with Category 38 of the Air Quality Permit Exemptions document tanker truck load out operations are required to be equipped with controls achieving VOC, and HAP emissions reductions of 95% or greater unless their uncontrolled VOC, single HAP, and total HAP emissions are below the control thresholds of 2.7 tpy, 0.5 tpy, and 1.0 tpy, respectively. Per GP-5 and GP-5A, tanker truck load-out operations that take liquids from storage vessels with emissions above the control thresholds are required to use a vapor balancing system and ensure each truck used to unload liquids has passed an annual leak test.<sup>171</sup>

**What are examples of process changes/modifications that reduce or eliminate emissions/waste from this equipment or process?**

The addition of the controls and/or practices outlined above can reduce methane emissions from tanks. These strategies are widely utilized and required by permit.

<sup>164</sup> Pennsylvania Dept. of Environmental Protection, Air Quality Permit Exemption Category No. 38 (Aug. 8, 2018).

<sup>165</sup> Department of Environmental Protection, Air Quality Permit Exemption 38, available at

<http://www.elibrary.dep.state.pa.us/dsweb/Get/Document-96215/275-2101-003.pdf>

<sup>166</sup> Pennsylvania Draft Proposed RACT Rulemaking for Control of VOC Emissions from Oil and Natural Gas Sources Annex, available at, [http://files.dep.state.pa.us/Air/AirQuality/AQPortalFiles/Advisory%20Committees/smallbiz/2019/4-17-19/7\\_ONG\\_PRN\\_Annex\\_A\\_AQTAC\\_4-11-2019.pdf](http://files.dep.state.pa.us/Air/AirQuality/AQPortalFiles/Advisory%20Committees/smallbiz/2019/4-17-19/7_ONG_PRN_Annex_A_AQTAC_4-11-2019.pdf)

<sup>167</sup> Regulations Respecting Reduction in the Release of Methane and Certain Volatile Organic Compounds (Upstream Oil and Gas Sector) (July 2019). Available at <https://laws-lois.justice.gc.ca/PDF/SOR-2018-66.pdf>

<sup>168</sup> British Columbia Oil & Gas Commission Regulation (2018), available at

[http://www.bclaws.ca/civix/document/id/regulationbulletin/regulationbulletin/Reg286\\_2018](http://www.bclaws.ca/civix/document/id/regulationbulletin/regulationbulletin/Reg286_2018)

<sup>169</sup> WDEQ, Oil and Gas Production Facilities Ch. 6, Section 2 Permitting Guidance for the UGRB (2016), available at

<http://deq.wyoming.gov/media/attachments/Air%20Quality/New%20Source%20Review/Guidance%20Documents/5-12-2016%20Oil%20and%20Gas%20Guidance.pdf>.

<sup>170</sup> U.A.C. § 307-504.

<sup>171</sup> Pennsylvania GP-5, GP-5A, Section F(1)(a).

## Technology Alternatives:

List of technology alternatives with link to information or contact information for the company/developers.				
Name/Description of Technology	Link (and contact info for company if available)	Availability	Feasibility	Cost Range (choose one)
Low production threshold / Vent	Need emissions inventory and remaining useful equipment analysis.	In use <u>or</u> in development		Low Medium High
VCU / Flare		In use <u>or</u> in development		Low Medium High
VRU / Gas Sales	<a href="https://hy-bon.com/blog/faq-about-vapor-recovery-units/">https://hy-bon.com/blog/faq-about-vapor-recovery-units/</a>	In use <u>or</u> in development		Low Medium High
Equipment (VRT) / Separator operating Practices	<a href="https://greasebook.com/blog/separators-heater-treaters-pressure/">https://greasebook.com/blog/separators-heater-treaters-pressure/</a>	In use <u>or</u> in development		Low Medium High
Heater Treater operating practices		In use <u>or</u> in development	Region specific	Low Medium High
Relief devices and thief hatches operating practices		In use <u>or</u> in development		Low Medium High
Solar Heating for Site Located Oil Storage or Separation	Utilizes solar power to supplement fired combustors in heating oil to improve separation. Patent No: US 9,394,780 B2	In use <u>or</u> in development		Low Medium High
SCADA		In use	Typically used to monitor/control larger facilities due to high installation costs	
Secondary Vapor Capture				

What technology alternatives exist to reduce or detect emissions? Please list all alternatives identified along with contact information for further investigation of this technology or process.

Radiant heat transmitted to stored hydrocarbons can affect product vaporization and increase vent flows from storage. In hot climates, lighter colors were chosen to reduce evaporative product losses in tanks which would route to vent or flare depending on the configuration of the tank battery. As noted in the Khark island study (citation below) the impact of paint color (dark versus light) can impact the amount of product lost due to evaporation by



250%. Currently, storage tank paint color may be dictated through BLM, landowner agreement, etc. with the intent to minimize the aesthetic impact of facilities on the landscape. Flexibility in the choice of storage tank paint colors on new installations could reduce venting in cases where tank vents are not controlled and low pressure flaring on controlled installations.

Surface Color	Shade or Type	Solar Absorptance ( $\alpha$ ) (dimensionless) Surface Condition	
		Good	Poor
Aluminum	Specular	0.39	0.49
Aluminum	Diffuse	0.60	0.68
Beige/Cream		0.35	0.49
Brown		0.58	0.67
Gray	Light	0.54	0.63
Gray	Medium	0.68	0.74
Green	Dark	0.89	0.91
Red	Primer	0.89	0.91
Rust	Red iron oxide	0.38	0.50
Tan		0.43	0.55
White	—	0.17	0.34
Aluminum	Mill finish, unpainted	0.10	0.15

Figure 5. Solar Absorptance for Selected Tank Surfaces

<https://www.technokontrol.com/pdf/evaporation/evaporation-loss-measurement.pdf>

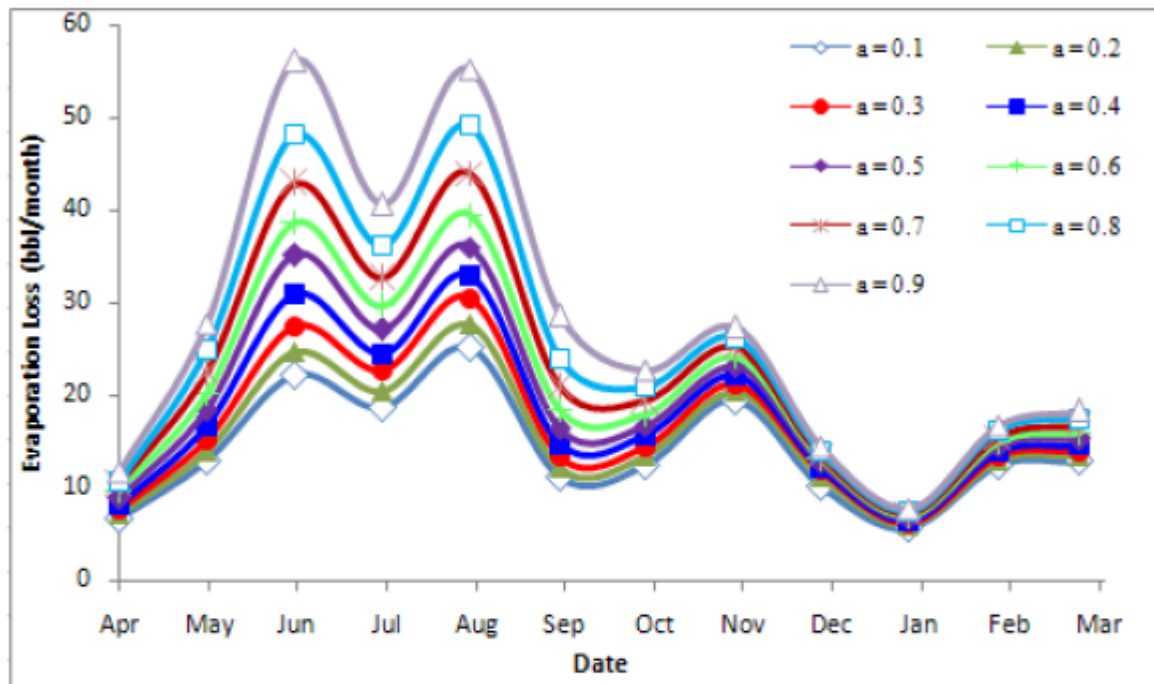

**Figure 14.** Surface paint absorptivity effects on monthly variations of the evaporative losses.

<https://www.researchgate.net/publication/271227741> Effects of outer surface paint color on crude oil evaporative loss from the Khark Island storage tanks

NOTE: See other topic papers for LDAR, flaring, venting, compressors, and pneumatics.

What are the pros and cons of the alternatives?

This is discussed above in the table. Many of them are already in use per best practice and regulation.

What is needed and available for new wells?

Discussed above in table.

What is needed and available for existing wells?

Discussed above in table.

What technology alternatives exist for this equipment or process itself?

Discussed above in table

**What are the pros and cons of the alternatives?**

Discussed above in table.

**Costs of Methane Reductions:**

**What is the cost to achieve methane emission reductions?**

No new controls are necessary due to current control mechanisms and efficiency of process.

A 2014 ICF International Report analyzed the cost of vapor recovery units (VRUs), which collect and compress gas, which can then be re-directed to a sales line, used on-site for fuel, or flared. The report states, “[B]ased on Gas STAR and industry data, the capital cost of this measure is assumed to be \$100,000 with an operating cost (electricity) of \$7,500 per year and a reduction of 13,410 Mcf per year. This yields a reduction cost of -\$0.51/Mcf if the gas is recovered for sale or \$4.57/Mcf if it is flared.”<sup>172</sup> The recently released Synapse report estimates the unit cost (\$/mcf of reduced methane) of adding VRUs to oil and condensate tanks to be \$4.18 and the unit cost (\$/tonne of reduced methane) to be \$217.36.<sup>173</sup>

In connection with Colorado’s proposed rule for lowering the control threshold for tanks from 6 tpy to 2 tpy, the Colorado AQCC estimated the annualized cumulative cost of installing 65 flare control devices in the Denver Metro Front Range North (DMFRN) area to be about \$421,700 dollars, with an average cost effectiveness of about \$2,232 per ton of VOC reduced. For the smallest category of tanks (2-3 tpy) the incremental cost of controls on 36 tanks is estimated at \$2,843 per ton of VOC reduced.<sup>174</sup> For crude oil and water tanks in the remainder of the state, the AQCC estimates the annualized cost of installing 202 flare control devices at about \$1.31 million dollars with an average cost effectiveness of about \$1,512 per ton of VOC reduced. For the smallest category of tanks (2-3 tons/year) the incremental cost of controls on 80 tanks is estimated at \$2,688 per ton of VOC reduced.<sup>175</sup> For condensate tanks outside the DMFRN, the estimated annualized cost of installing 444 flare control devices is about \$2.88 million dollars with an average cost effectiveness of about \$1,679 per ton of VOC reduced. For the smallest category of tanks (2-3 tons/year) the incremental cost of controls on 175 tanks is estimated at \$2,817 per ton of VOC reduced.<sup>176</sup> Colorado estimates the cost of a vapor collection and return system to control tank loadout emissions to be \$12,000-\$15,000 for initial set-up. Per the Colorado Initial Economic Impact, “Emission reductions will depend on how frequently the storage tank is unloaded. EPA estimates the cost purchasing additional connections to route a transport vehicle vent to a useful outlet at \$1,000 (estimated implementation cost) and additional operating costs to connect the lines at \$200 (incremental operating cost). EPA also estimates that recovering these vapors can payback in two years depending on the frequency of loading, load volumes, and the value of the gas.<sup>27</sup> In most cases, the storage tank will already be controlled as required by the Regulation Number 7 storage tank control programs; therefore, the additional costs to control the transport vehicle emissions are related only to the installation of

<sup>172</sup> ICF International, Economic Analysis of Methane Emission Reduction Opportunities in the U.S. Onshore Oil and Natural Gas Industries (Mar. 2014), available at [https://www.edf.org/sites/default/files/methane\\_cost\\_curve\\_report.pdf](https://www.edf.org/sites/default/files/methane_cost_curve_report.pdf)  
<sup>173</sup> Synapse, Cost-Effectiveness of Comprehensive Oil and Gas Emissions Reduction Rules in New Mexico (Sept. 2019), available at <http://blogs.edf.org/energyexchange/files/2019/09/Synapse-Methane-Cost-Benefit-Report.pdf>  
<sup>174</sup> Economic Impact Analysis (Initial Analysis), Proposed Revisions to ACQQ Reg. 7(Sept. 19, 2019), available at <https://drive.google.com/drive/folders/14fvt4COTzl79to4c2tVuLDKucksk5uaB>  
<sup>175</sup> *Id.*  
<sup>176</sup> *Id.*

vapor return lines to the storage tank such that transport vehicle emissions are then routed to the existing control device.”<sup>177</sup>

The California Air Resources Board estimates the cost of installing VRUs for tanks at \$4,700,000 annually, with annual savings of \$500,000. CARB estimates reductions from the installation of VRUs of 540,000 MT CO<sub>2</sub>e, with a cost per ton of \$9 per MT CO<sub>2</sub>e reduced (using the 20 year GWP). The Cost per Ton is estimated at \$25 per MT CO<sub>2</sub>e reduced using the 100 year GWP.<sup>178</sup>

What would be the implementation cost?

For new wells?

N/A

For existing wells?

N/A

Are there low-cost solutions available?

N/A

If a solution is high-cost, why is that the case?

N/A

Are there additional technical analyses needed to refine benefits/costs estimates?

N/A

### 3. IMPLEMENTATION

For each piece of equipment or process, please consider the following questions and add other relevant information. If relevant, please identify if the answers are different for large company and small company requirements or are different for well type or basin.

#### Implementation Feasibility:

What is the feasibility of implementation (availability of required technology or contractors, potential permitting requirements, potential for innovation)?

See above section on economic and technical analysis of replacements/retrofits.

What is the useful life of equipment?

<sup>177</sup> CO APCD, Economic Impact Analysis (Initial Analysis), Sept. 19, 2019, p. 29, available at <https://drive.google.com/drive/folders/14fvt4C0Tzl79to4c2tVuLDKucksk5uaB>

<sup>178</sup> 17 C.C.R. §§95665 et seq., Subarticle 13: Greenhouse Gas Emission Standards for Crude Oil and Natural Gas Facilities, Attachment 2: Summary of Cost, Emissions, and Cost per Ton using the 20 year and 100 year GWP, respectively, available at <https://ww3.arb.ca.gov/regact/2016/oilandgas2016/oilgasatt2.pdf>

Standard life of control equipment. Processing and storage vessels generally have long useful lives, 20 to 30 years is common.

What are the maintenance and repair requirements for equipment required for methane reduction?

Discussed in table

How would emissions be detected, reductions verified and reported?

Emissions from storage vessels are calculated as part of an NMED air permit application and reported to NMED as part of any required emission inventories. This includes emissions that result from the volume of tank vapors routed at low pressure to an enclosed combustor or flare used as a control device.

No direct measurement; calculate pre and post-actual/PER for the control technology.

Remote monitoring of control equipment.

## 4. CHALLENGES AND OPPORTUNITIES TO ACHIEVE METHANE REDUCTION IN NEW MEXICO

For each piece of equipment or process, please consider the following questions and add other relevant information. If relevant, please identify if the answers are different for large company and small company requirements or are different for well type or basin.

What regulatory gaps exist for this equipment or process? Are there regulatory gaps filled by the proposed implementation?

None.

Where do conflicting priorities exist between NMED, EMNRD, and NMSLO? Are there opportunities for coordination between these agencies?

None

Are there existing regulations related to methane that do not address the intended purpose? Identify any unintended barriers to methane reductions/capture that may hinder proposed processes.

No

Other considerations or comments (e.g. particular design or technological challenges/opportunities, co-benefits, non-air environmental impacts, etc.):

None

## 5. SEPARATORS - PATH FORWARD<sup>179</sup>

	OPTIONS	DESCRIPTION AND LINK TO INFORMATION IF AVAILABLE. PLEASE LIST THE BENEFIT THAT COULD BE ACHIEVED THROUGH THIS OPTION AND ANY DRAWBACKS OR CHALLENGES TO IMPLEMENTATION	EFFECTIVENESS OF COST NOW (choose one)	REPORTING, MONITORING AND RECORDING OPTIONS, INCLUDING REMOTE DATA COLLECTION	IS THIS OPTION HELPFUL IN THE SAN JUAN BASIN, PERMIAN BASIN OR BOTH
8.1	Applicability threshold	Storage tank equipment control requirements for existing facilities, not already subject to NSPS OOOO/OOOOa, should be based on appropriate thresholds. American Petroleum Institute’s December 4, 2015 comments to EPA on the draft Control Techniques Guidelines suggests that a 15 tons per year VOC threshold is appropriate as existing source retrofits are more costly than controls on a new source. The throughput impacts the ability of the control equipment to function effectively. As noted in EPA’s OOOO/OOOOa, requiring controls for new storage tanks below a certain VOC threshold may not be effective. For existing storage tanks, the control threshold will be even higher due to the additional cost to retrofit the equipment.	<b>LOW</b> <b>MODERATE</b> <b>HIGH</b>	Covered in NMED permit conditions	San Juan  Permian  Both
<b>COMMENT</b>			<b>SUGGESTION TO MAKE THIS OPTION MORE WORKABLE:</b>		
8.2	Controls – VCUs and VRUs: Consider incorporating VCUs and VRUs into facility design to capture additional “flash		<b>LOW</b> <b>MODERATE</b> <b>HIGH</b>	Covered in NMED permit conditions	San Juan  Permian

<sup>179</sup> The format of the Path Forward table evolved over the course of the meetings as the group tried to identify the best method for capturing the most useful information. As a result, there is some variation in the table headers from topic to topic in the final consolidated report.

	gas” not captured by separator, especially early in the well life when production is highest.				Both
	COMMENT		SUGGESTION TO MAKE THIS OPTION MORE WORKABLE:		
8.3	Separators / VRTs: Optimize separator design/operating parameters to maximize gas separation. Consider use of VRT after the separator as a second opportunity to minimize “flashing” in the storage tanks.	The facility should be designed and operated to safely recover as much flash gas as possible prior to storage.	<b>LOW MODERATE HIGH</b>	Covered in NMED permit conditions	San Juan Permian Both
	COMMENT		SUGGESTION TO MAKE THIS OPTION MORE WORKABLE:		
8.4	Inclusion of controlled tanks and relief devices in site specific LDAR	Minimize leaks from controlled tanks and relief devices through their inclusion in the existing site specific LDAR program (at the same frequency as the existing program).			San Juan Permian Both
	COMMENT		SUGGESTION TO MAKE THIS OPTION MORE WORKABLE:		
8.5	Control storage tanks with emissions above specified threshold (e.g., 10 tpy of CH4 or 2 tpy of VOCs) by 98%	See discussion above of CARB and Colorado proposed requirements in section discussing existing reduction strategies.	<b>Cost effective</b>	Robust recordkeeping and reporting requirements essential for compliance monitoring	San Juan Permian Both
	COMMENT		SUGGESTION TO MAKE THIS OPTION MORE WORKABLE:		

8.6	Require operators route tank emissions to VRU unless technically infeasible.	See discussion above of CARB requirements in section discussing existing reduction strategies.	<b>Cost effective</b>	Robust recordkeeping and reporting requirements essential for compliance monitoring	San Juan Permian Both
COMMENT			SUGGESTION TO MAKE THIS OPTION MORE WORKABLE:		
8.7	Require operators use automated tank gauges to reduce fugitive emissions from thief hatches	See discussion above of Colorado proposed requirements in section discussing existing reduction strategies.	<b>Cost effective</b>	Robust recordkeeping and reporting requirements essential for compliance monitoring	San Juan Permian Both
COMMENT A. Require operators to install vapor balance return lines. Delay effective date of regulations (by 1 year) to allow truck drivers to receive training and certification in operation. Require monitoring and reporting.			SUGGESTION TO MAKE THIS OPTION MORE WORKABLE:		
8.8	Require operators control emissions during unloading of emissions from tanks into trucks	See discussion above of Colorado proposed requirements in section discussing existing reduction strategies.	<b>Cost effective</b>	Robust recordkeeping and reporting requirements essential for compliance monitoring	San Juan Permian Both
COMMENT			SUGGESTION TO MAKE THIS OPTION MORE WORKABLE:		
8.9	Convert Water Tank Blanket from Natural Gas to Produced CO2 Gas	<a href="https://www.epa.gov/sites/production/files/2016-06/documents/convertwatertank.pdf">https://www.epa.gov/sites/production/files/2016-06/documents/convertwatertank.pdf</a>  Natural Gas STAR Partner has switched water tank blanket from natural gas to CO2-rich produced gas, saving 32,600 Mcf per year of methane.	\$1,000-\$10,000		San Juan Permian Both



	COMMENT A. There is an applicability restraint for this option: "This practice can be implemented where there is a source of CO2-rich produced gas or a nearby gas processing plant with acid gas removal."		SUGGESTION TO MAKE THIS OPTION MORE WORKABLE:		
8.10	Recover Gas During Condensate Loading	<a href="https://www.epa.gov/sites/production/files/2016-06/documents/recyclelinerecovers.pdf">https://www.epa.gov/sites/production/files/2016-06/documents/recyclelinerecovers.pdf</a>  Natural Gas STAR: "Lease condensate production, when transferred from storage into tank trucks, can generate significant volumes of methane vapor due to pressure and temperature changes and evaporation. This methane is typically vented to the atmosphere to prevent the internal tank pressure from rising. One [Natural Gas STAR] Partner reported capturing methane that would otherwise be vented by connecting the tank truck vent to the condensate storage tank, or to a vapor recovery line... Partners have reported reducing methane emissions by 6,500 Mcf to 39,000 Mcf per year, which includes flashing loses."	< \$1,000		San Juan  Permian  Both
	COMMENT Applicability "This technology applies to all condensate production operations using tank trucks or railroad tanks."		SUGGESTION TO MAKE THIS OPTION MORE WORKABLE:		
8.11	Install Pressurized Storage of Condensate	<a href="https://www.epa.gov/sites/production/files/2016-06/documents/installpressurized.pdf">https://www.epa.gov/sites/production/files/2016-06/documents/installpressurized.pdf</a>  Natural Gas STAR: "When transferred to atmospheric storage tanks, a pressure drop occurs causing the methane to flash out. Operators often vent this gas to the atmosphere. Interstage knockout in multi-stage compressors with interstage cooling also contains raw natural gas liquids (NGL) saturated in methane. If transferred to atmospheric storage, nearly all the methane will flash and vent to the atmosphere"	\$10,000-\$50,000		San Juan  Permian  Both

		One [Natural Gas STAR] partner reported installing pressurized storage, requiring pressurized transport of condensate to a gas plant for economic recovery of gas liquids and associated methane, volatile organic compounds (VOCs), and hazardous air pollutants (HAPs) emissions reductions...Total partner reported methane emissions savings were 27,992 Mcf per year for 4 installations of pressurized storage tanks.”			
COMMENT		SUGGESTION TO MAKE THIS OPTION MORE WORKABLE:			
A. Applicability: This technology is applicable on all gas well and gathering/booster compressors.					
8.12	Apply control threshold to tank emissions from all tanks located at a facility, rather than individual tanks or individual tanks manifolded together.	See discussion above about Wyoming and Utah approaches.			
COMMENT		SUGGESTION TO MAKE THIS OPTION MORE WORKABLE:			
8.13	Consider installation of remote monitoring to notify/control critical controllers or components, such as malfunctioning dump valves or open thief hatches	Programmable Logic Control (PLC), Supervisory Control and Data Acquisition (SCADA) systems, etc. allow operators to monitor, trend, and control different aspects of their process that are enabled through the use of instrumentation (e.g. Pressure Transmitters, Flow Transmitters, Level Switches, Level Transmitters, etc.). While SCADA is installed for operational purposes, analysis of that data and integration of more SCADA over time can result in lower emissions as facilities are run more efficiently. PLC and SCADA systems require both instrumentation and communication equipment. This poses an economic burden and may not be scalable to smaller operators or many existing locations.			
COMMENT		SUGGESTION TO MAKE THIS OPTION MORE WORKABLE:			

8.14	Consideration of a control credit similar to TCEQ program	See page 12 of <a href="#">Enhanced Vapor Recovery presentation</a> . The addition of additional control equipment can result in an increased percent emission reduction credit.			
COMMENT			SUGGESTION TO MAKE THIS OPTION MORE WORKABLE:		
8.15	Install enhanced vapor recovery in addition to a VRU system.	See <a href="#">Enhanced Vapor Recovery presentation</a> . This (or similar) enhanced gas recovery technology allows operators to capture up to 100% of flash gas for sale.  <a href="https://www.ecovaporrs.com/">https://www.ecovaporrs.com/</a>	Cost-effective (often economically beneficial)		
COMMENT			SUGGESTION TO MAKE THIS OPTION MORE WORKABLE:		

Natural Gas “Recommended Technologies”

<https://www.epa.gov/natural-gas-star-program/recommended-technologies-reduce-methane-emissions>

# SECTION 9, COMPLETIONS/ RECOMPLETIONS AND STIMULATIONS

Discussion for MAP members on August 30, 2019

---

NOTE: The focus of this report is processes, and the associated equipment, directly related to the release or capture of methane gas. We are not requesting information on processes/equipment that are not related to the release or capture of methane gas.

## 1. DESCRIPTION OF PROCESS AND EQUIPMENT

Provide a description of the processes and/or equipment used in oil and/or gas extraction for this topic. Note that this report template will be used for all topics of the MAP review and, thus, not all questions or information may be relevant for each topic. If information is not relevant, indicate N/A. Note any differences expected for differing well types, industry sector, or basin location.

### Technical description of the process or equipment:

A typical oil or gas well goes through several phases during its life. The first phase is the actual drilling of well. Drilling is followed by completions. After a well is completed the well can produce hydrocarbons for several years or decades. For an existing well, it may be necessary to complete a well stimulation to increase production in case of production decline. In any case, the emissions during completions/stimulations are associated with a relatively short period in a decades-long well life cycle.

All oil and natural gas wells must be “completed” after initial drilling in preparation for production. Oil and natural gas completion activities not only will vary across formations but can vary between wells in the same formation. Well completion activities include multiple steps after the well bore hole has reached the target depth. These steps include inserting and cementing-in well casing, perforating the casing at one or more producing horizons, and potentially hydraulically fracturing one or more zones in the reservoir to stimulate production.

Well stimulation is a well intervention performed on an oil or gas well to increase production by improving the flow of hydrocarbons from the reservoir into the well bore. Unconventional gas reservoirs are more dispersed and found in lower concentrations and may require stimulation (such as hydraulic fracturing) to extract hydrocarbons.

In the process of hydraulic fracturing, high-pressure fluid typically water emulsion, or inert gas, with a proppant (sand) is injected into the formation resulting in fractures of the formation rock. Typically, truck mounted pumps are used to inject the high-pressure fluid into the formation. The fracturing process is often carried out in stages on sections of the well tubing or casing. After each section of the well and formation is hydraulically fractured, plugs are inserted in the well prior to fracturing the next section. This process is repeated many times over the length of the wellbore.

Once the fracturing is completed, a workover/completion rig or coil tubing unit is used to drill through the plugs and begin the well cleaning process.

After a new or existing well has been hydraulically fractured and the plugs have been cleaned out, the well begins its flowback process which is primarily water (with additives) or inert gas and proppants. This material has to be evacuated to prepare the well for production. When flowback is initiated, various forces act on the fluid in the well tubing. These include the weight of frac fluid column itself, formation pressure, back pressure from the gas gathering line of the flowback gas and the surface equipment connected to the well. These forces have to be overcome in order for the fluids in the wellbore to come to the surface.

During the flowback, the fracturing fluid or a mix of hydrocarbons and fracturing fluid from the formation come to the surface. As the fracturing fluid flows to the surface, reservoir hydrocarbons and produced water replace the fracturing fluid in the well tubing. Thus, initially the amount of hydrocarbons coming to the surface is very limited. Initial flowback is discussed in the preamble to NSPS Subpart OOOOa regulations and can be found on Page 56630 of the following document:

<https://www.govinfo.gov/content/pkg/FR-2015-09-18/pdf/2015-21023.pdf>. As the fracturing fluid reach the surface, they are processed per New Source Performance Standards (NSPS) regulations, 40 CFR Part 60, Subpart OOOOa which govern the managing of fluids during flowback. In most cases, NSPS OOOOa requires Reduced Emission Completions (RECs) as discussed later. The regulations are available at [https://ecfr.io/Title-40/sp40.8.60.oooo\\_0a](https://ecfr.io/Title-40/sp40.8.60.oooo_0a). The regulations related to well completions are at 40 CFR §60.5375a.

Useful information on RECs can be found at <http://www.ipieca.org/resources/energy-efficiency-solutions/units-and-plants-practices/green-completions/>.

**Provide the segment(s) of the industry that the equipment or process is found:**

This process is found in the oil and gas production segment of the industry.

Describe how the equipment or process is used:

Reduced emission completions are mandated by NSPS Subpart OOOOa regulations for both gas and oil wells with some exceptions for certain well types. In many cases, the flowback is first routed to a solids separator (often called a sand trap). This is necessary since some of the sand that is injected in the hydraulic fracturing process comes back to the surface along with the injected water. Removal of solids is needed to prevent damage to downstream equipment. From the solids separator the fluid can be routed to additional separators where gas, oil, and water can be separated. Once gas quality is such that it can meet specifications for gas sales, it is typically routed to a sales line unless it is technically infeasible to do so. In that case, gas must be combusted until there is a fire hazard or a negative impact to tundra, permafrost or waterways.

Provide the common process configurations that use this equipment or process:

Typical equipment used in flowback can include sand separator, two or three phase separators, frac tanks, tanks, completion combustion device, or permanent production-phase equipment. Depending upon the amount of flowback expected and the availability of equipment to be used during production, flowback can be routed to temporary equipment or the permanent equipment. The flowback period typically lasts for days or a few weeks following which the well transitions to a production phase. The flowback period ends when either the well is shut in and permanently disconnected from the flowback equipment or at the startup of production. NSPS Subpart OOOOa has different gas capture requirements for initial flowback and separator flowback. During initial flowback, gas may be vented if it is technically infeasible for a separator to function (i.e., any gas present in the initial flowback stage is not subject to control under NSPS OOOOa). During separator flowback all gas must be recovered and sold or rescued if technically feasible to do so. If not technically feasible, it must be routed for combustion. NSPS Subpart OOOOa hydraulic fracturing requirements are now in place for all hydraulic fracturing operations onshore in the U.S.

What is the distribution of the equipment or process across business segments?

This process primarily relates to the onshore oil and gas production sector.

How has this equipment or process evolved over time?

Hydraulic fracturing itself has used since the 1940's in the industry.

There are many reported instances where industry started voluntarily using reduced emission completions (REC). EPA's Natural Gas STAR program has reports of RECs since the 2004. These

voluntary activities resulted in reduced emissions as reported by various operators. Additional information about the Natural Gas STAR program and reduced emission completions can be found at [https://www.epa.gov/sites/production/files/2016-06/documents/reduced\\_emissions\\_completions.pdf](https://www.epa.gov/sites/production/files/2016-06/documents/reduced_emissions_completions.pdf) <https://www.epa.gov/sites/production/files/2017-09/documents/greencompletions.pdf>

Federal regulations first addressed emission associated with completions in the 2012 NSPS regulations at 40 C.F.R. Part 60 Subpart OOOO: <https://www.ecfr.gov/cgi-bin/text-idx?node=sp40.7.60.oooo> . These regulations require the use of RECs to completions at gas wells following hydraulic fracturing. NSPS Subpart OOOOa, finalized in 2016, requires RECs for oil wells as well.

## 2. INFORMATION ON EQUIPMENT OR PROCESS COSTS, SOURCES OF METHANE EMISSIONS, AND REDUCTION OR CONTROL OPTIONS

Identify the capital and operating costs for the equipment or the process. Identify how methane is emitted or could be leaked into the air. Please **prioritize** the list to identify first the largest source of methane from the process or equipment and where there is **potential** for the greatest reduction of methane emissions. Note any differences expected for differing well types, industry sector, or basin location.

### **Sources of Methane:**

Provide an overview of the sources of methane from this equipment or process:

During the hydraulic fracturing process itself, injection of water, or inert gas, and proppant is handled by pumps powered by engines. This process itself lasts only a few days per well depending upon the well stimulation design. The emissions during the actual hydraulic fracturing are combustion emissions associated with diesel usage.

The flowback period involves the return to surface of the fracking fluids, or inert gas, as well as some formation hydrocarbons. This is the primary source of methane emissions for completions activity. NSPS Subpart OOOOa requires that, when feasible, hydrocarbons are captured and sent to sales or combusted if sales are not technically feasible.

### New Wells:

New wells that fall into the category of wildcat or delineation, wells or low-pressure wells are allowed to route the recovered gases during flowback to a completion combustion device. In this case, the emissions of methane are due to uncombusted methane from the combustion device.

Low pressure wells may also be exempted from sending entrained gas to sales instead sending the full stream of production to a well completion vessel or frac tank.

New wells that do not fall into the wildcat or delineation, category are required to route gas emissions of saleable gas to a gas sales line unless it is technically infeasible to do so, in which case the gas must be sent to a completion combustion device.

Existing Wells:

The same requirements apply to refracturing at existing wells as for new wells. It is however, less likely that existing wells will meet the definitions of a wildcat well. Note there may be technical infeasibility due to reservoir low pressure to operate control equipment on the surface.

The Grant Schreiber study (below), based on Gas Capture Plans submitted by operators in San Juan and Rio Arriba Counties in November 2018, found that 100% of Gas Capture Plans provided for either venting or flaring of recompletions—with 68.5% of recompletions vented and 31.5% of recompletions flared.

**Grant-Schreiber Study**

Grant Schreiber Summary of OCD Gas Capture Plans San Juan/Rio Arriba recompletions. November, 2018

Government source: OCD online/Dist. 3 office Reports of data: OCD Gas Capture Plans example attached

Published peer review: NA

Published non-peer: NA

Unpublished: NA

Date	MCF Rio Arriba / Day	MCF San Juan / Day	Vented or Flared
1/11/18	686		V
	500		F
	500		F
	500		F
	356		V
	431		V
	686		V
	500		F
	500		F
	500		F
		390	V
	502		V
	245		V



1/25/18	500		F
	500		F
2/8/18	500		F
	500		F
	500		F
	500		F
	450		F
	302		V
	234		V
	200		V
	347		V
		162	V
3/8/18	302		V
	500		F
	300		V
	180		V
	500		F
	360		V
5/3/18		300	V
	500		V
	500		V
	500		V
	500		V
		310	V
5/17/18	500		V
	500		V
		310	F
		300	V
		300	V
		340	V
		290	V
	450		V
	500		V
		295	V
		310	F
7/12/18		290	V
		310	V
8/23/18		310	V
		310	V
11/15/18		450	V
<b>Total</b>	<b>(36 wells)</b>	<b>(18</b>	<b>*</b>
<b>MCF</b>	<b>17,031</b>	<b>wells)</b>	<b>**</b>
		<b>4,977</b>	<b>***</b>

\*68.5% of recompletions (37 wells) are vented

\*\*31.5% of recompletions (17 wells) are flared

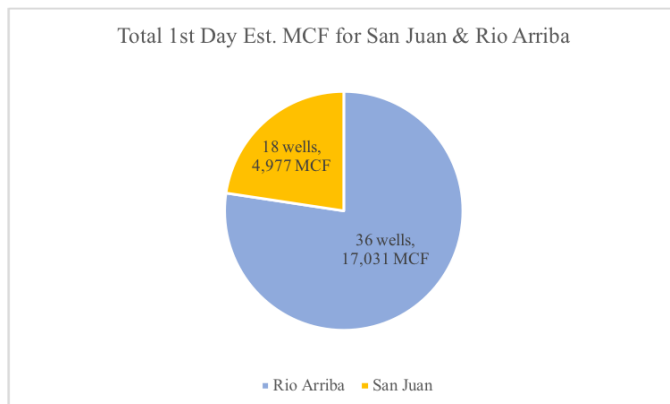

Note on the study [from non-participants]: During the Methane Advisory Panel's discussion about data located in OCD Gas Capture Plans, it was suggested that Gas Capture Plan data should not be used to characterize emissions that may occur after recompletions. Data entered into the Gas Capture Plans reflect estimates made prior to the project taking place and are merely estimated volumes of what could happen to produced gas. Accordingly, vented and flared volumes represented in Gas Capture Plans are estimates of what could be potentially vented or flared if there isn't a gathering or sales pipeline in place for the pipeline quality gas and are not accurate. It was instead suggested that information on production accounting reports from the OCD be used when discussing green completion emissions. The data from the production accounting reports reflects actual data points following completion and are far more accurate. In addition, the data from the Grant Schreiber study as described contains no context or other explanation regarding controls, volumes, timing or whether the venting or flaring was conducted pursuant to regulation.

#### How are the emissions calculated for this equipment or process?

Emissions from this source can be calculated using the EPA GHG reporting rule (Subpart W) or at <https://ecfr.io/Title-40/sp40.23.98.w>. These are reported to EPA in accordance with the GHG reporting rule. Equations for estimating emissions from well venting during completions and workovers with hydraulic fracturing are given at 40 CFR 98.233(g), Equations W-10A and W-10B.

#### What data is available to quantify emissions/waste for this equipment?

EPA has discussed emissions from this source in Section 1 of the Technical Support Document for the NSPS OOOO regulation found here: <https://www.regulations.gov/document?D=EPA-HQ-OAR-2010-0505-4550>.

In 2017, the total methane emissions reported from Petroleum and Natural Gas Systems for the entire country were 88 million metric tons CO<sub>2</sub>e. The onshore production sector reported approximately half or 44 million metric tons CO<sub>2</sub>e. Of these, well completion and workovers with hydraulic fracturing reported approximately 1 million metric tons CO<sub>2</sub>e. This number is an approximation from the sector summary. Thus, the methane emissions from the well completions sector are approximately 2% of total methane emissions from the onshore production sector or approximately 1% of total methane emissions from the Petroleum and Natural Gas Systems sector.

[https://www.epa.gov/sites/production/files/2018-10/documents/subpart\\_w\\_2017\\_industrial\\_profile.pdf](https://www.epa.gov/sites/production/files/2018-10/documents/subpart_w_2017_industrial_profile.pdf)

Allen et al (2013), University of Texas and Environmental Defense Fund (EDF) study did actual measurements from 27 completions in various areas of the country. The study can be found here:

<https://www.pnas.org/content/110/44/17768>

The duration of the flowbacks in their study ranged from 5 hours to 2 weeks. Measured emissions of methane over an entire completion averaged to be about 1.7 metric tons methane with a range of 0.01 to 17 metric tons. They extrapolated these values to come up with estimates of national methane emissions from completions ranging from 0.125 million metric tons of CO<sub>2</sub>e to 0.675 million metric tons of CO<sub>2</sub>e with an average of 0.45 million metric tons of CO<sub>2</sub>e. These are less than the EPA GHG reported number of approximately 1 million metric tons CO<sub>2</sub>e for 2017.

What are the data gaps in quantifying emissions/waste for this equipment?

These emissions are estimated and reported in accordance with the GHG reporting rule.

### **Economic Description of the Process or Equipment:**

What is the per unit cost of the equipment or the costs associated with the process?

The total cost of completion events including hydraulic fracturing greatly varies depending upon the well, hydraulic fracturing setup, length of flowback, availability of permanent equipment, sales line availability and quality of gas.

The cost of RECs with and without combustion has been discussed in detail in the Technical Support Documents to the EPA NSPS Subparts OOOO and OOOOa regulations. The costs are with and without any anticipated savings from sale of recovered gas. Note that the Technical Support Documents provide economic data that is generalized across the Onshore industry for both gas (2012) and oil (2015) wells, and that this data is not specific to New Mexico.

The Technical Support Document for NSPS OOOO regulations discusses emissions and control options in Sections 1 through 4 of

Section 9, Completions, Recompletions and Stimulations Topic Paper

<https://www.regulations.gov/document?D=EPA-HQ-OAR-2010-0505-4550>

The Technical Support Document for NSPS OOOOa regulations discusses emissions and control options in Section 3 of

<https://www.regulations.gov/contentStreamer?documentId=EPA-HQ-OAR-2010-0505-7646&attachmentNumber=6&contentType=pdf>

Detail spreadsheet about the costs associated with the controls is found in this attachment to the Technical Support Document:

<https://www.regulations.gov/contentStreamer?documentId=EPA-HQ-OAR-2010-0505-7646&attachmentNumber=14&contentType=excel12book>

Note that in certain circumstances that the Technical Support Documents are no longer representative in that the economic data is not always reflective of current design, but they do have the best data we have thus far. The oil and gas completions and stimulation industry is regularly evolving. While traditional stimulation activities and equipment exist, the data does not take into account permanent facility utilization.

What are the annualized operating costs for the equipment or costs associated with the process?

See above

If the equipment or process is powered, what are the costs?

See above

What is the useful life of the equipment?

The REC and rig/stimulation equipment is used for several hours or weeks during the completion, stimulation and flowback operations. Well servicing, coil tubing and stimulation equipment have a useful life primarily based upon the power unit, but is also limited based upon technological advances requiring a different tool for the job.

What are the maintenance and repair requirements for existing or new equipment?

Maintenance costs are included in the cost of the equipment above.

### **Existing Reduction Strategies:**

How has industry reduced emissions/waste from this equipment or process historically?

NSPS requirements have been applicable to completions following hydraulic fracturing for gas wells since 2012 and for oil wells since 2016. Prior to 2012, while many operators practiced voluntary RECs,

various configurations were prevalent including allowing the flowback to flow into frac tanks with the gas being vented or combusted.

Voluntary reductions from completions with hydraulic fracturing are also discussed in Section 5.0 of the NSPS OOOO Technical Support Document at: <https://www.regulations.gov/document?D=EPA-HQ-OAR-2010-0505-4550>

There are many reported instances where industry started voluntarily using reduced emission completions. EPA's Natural Gas STAR program has reports of RECs since the 2004. These voluntary activities resulted in reduced emissions as reported by various operators. Additional information about the Natural Gas STAR program and reduced emission completions can be found at [https://www.epa.gov/sites/production/files/2016-06/documents/reduced\\_emissions\\_completions.pdf](https://www.epa.gov/sites/production/files/2016-06/documents/reduced_emissions_completions.pdf) <https://www.epa.gov/sites/production/files/2017-09/documents/greencompletions.pdf>

#### New Wells:

#### Existing Wells:

#### How have the emission/waste reductions been measured?

Emissions from completions are reported annually to EPA's GHG reporting program. Based on industry sector summaries of Petroleum and Natural Gas systems, the methane emissions from completions have decreased from approximately 7 million metric tons CO<sub>2</sub>e in 2012 to approximately 1 million metric ton CO<sub>2</sub>e in 2017. References for the above estimates are found on Pages 7 and 9 respectively of the following documents:

<https://www.epa.gov/sites/production/files/2015-07/documents/petroleumandnaturalgassystemsector2012.pdf>

[https://www.epa.gov/sites/production/files/2018-10/documents/subpart\\_w\\_2017\\_industrial\\_profile.pdf](https://www.epa.gov/sites/production/files/2018-10/documents/subpart_w_2017_industrial_profile.pdf)

EPA's GHG Emissions database EnviroFacts allows for download and additional analysis of reported GHG emissions. The database can be accessed here:

<https://www.epa.gov/enviro/greenhouse-gas-customized-search>

While nationally emissions have decreased, in the Permian Basin, total GHG emissions (including both CO<sub>2</sub> and methane) from completions have increased from approximately 82,481 million metric tons CO<sub>2</sub>e in 2015 to approximately 615,096 million metric tons CO<sub>2</sub>e in 2016 and 974,877 million metric tonnes in 2017. Further, the CO<sub>2</sub>e figures are converted from raw methane at a GWP of 25 rather than the current 100-year GWP recognized by the IPCC of 36 suggesting that, along with the 25,000 metric ton GHGRP reporting threshold, the EPA figures represent a potentially significant underestimation of completion emissions.

Section 9, Completions, Recompletions and Stimulations Topic Paper

In 2017, as reported to EPA and downloaded from EPA’s EnviroFacts database, emissions associated with completions and workovers in the Permian basin are 7,773 metric tons of methane relative to 184,941 metric tons of methane from all sources in the onshore petroleum and natural gas production sector for Permian basin. Thus, the emissions are approximately 4% of the total onshore production sector emissions.

Completion and workover emissions with hydraulic fracturing for New Mexico for 2017 were downloaded from the EnviroFacts Database and are as follows.

San Juan Basin (NM only)– 124 metric tons methane

Permian Basin (NM only) - 1867 metric tons methane

NM emissions for both basins – 1994 metric tons methane

The trend from methane emissions associated with completions and workover emissions with hydraulic fracturing is shown in the chart

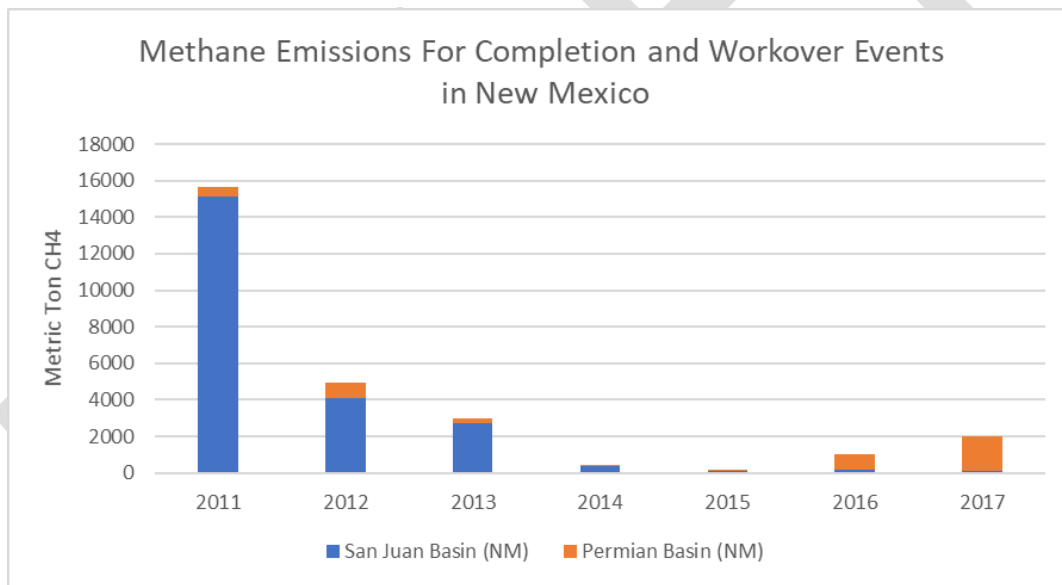

On a per-completion basis, methane emissions are as follows:

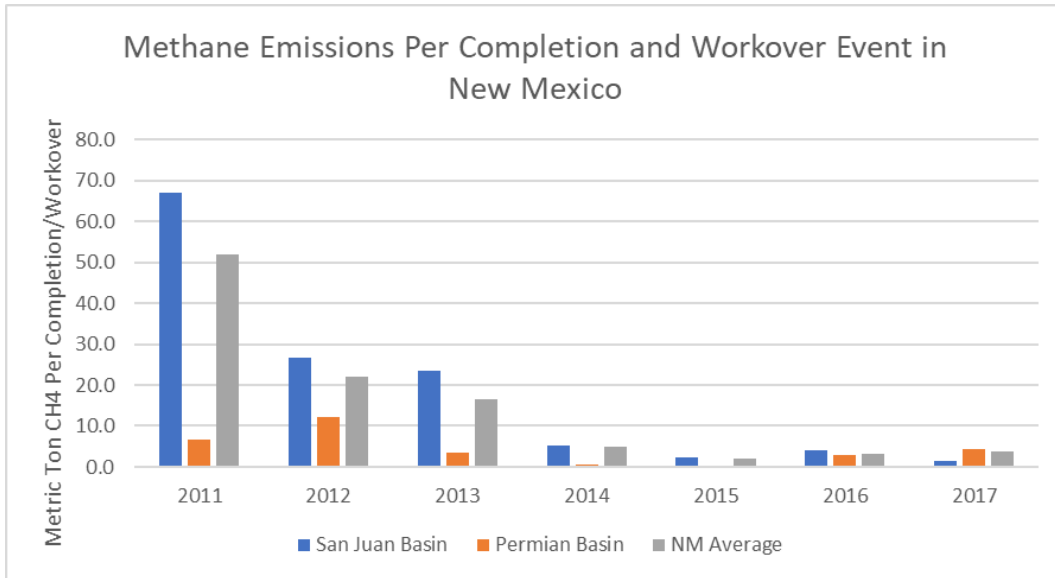

Further analysis of the data indicated an operator had relatively elevated emissions compared to the number of completions. When contacted, the operator revealed that some of the reported emissions were in error and that corrected data has been submitted to EPA. However, the EPA database has not been updated with the corrected data as of September 2017.

Using the corrected data, the emissions are as follows:

San Juan Basin (NM only)– 124 metric tons methane

Permian Basin (NM only) - 645 metric tons methane (instead of 1867 metric tons methane)

Total NM for both basins – 769 metric tons methane (instead of 1994 metric tons methane)

The revised charts are presented below:

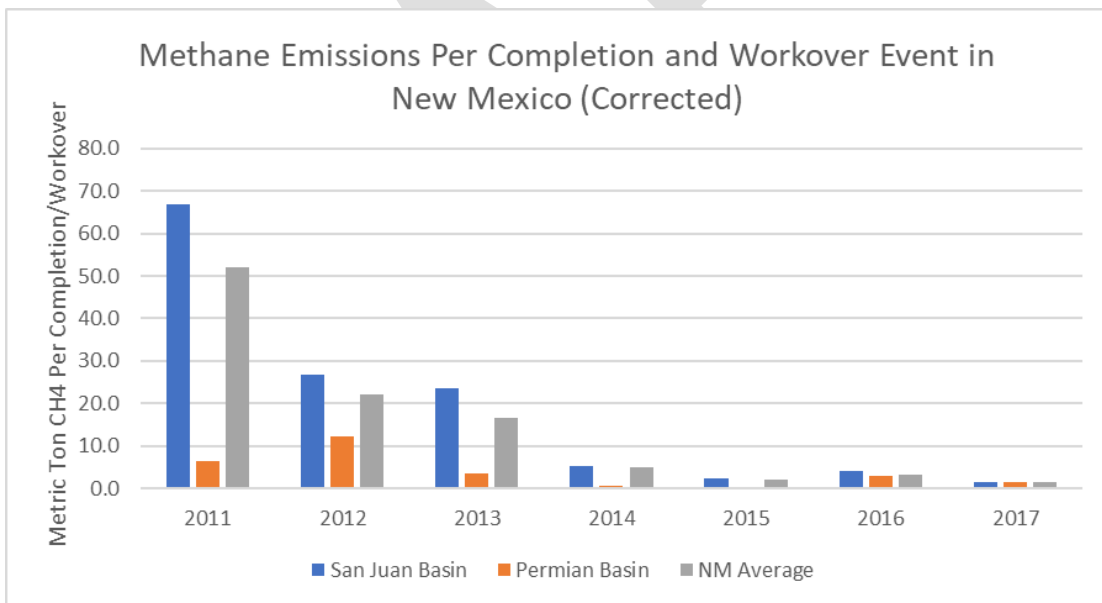
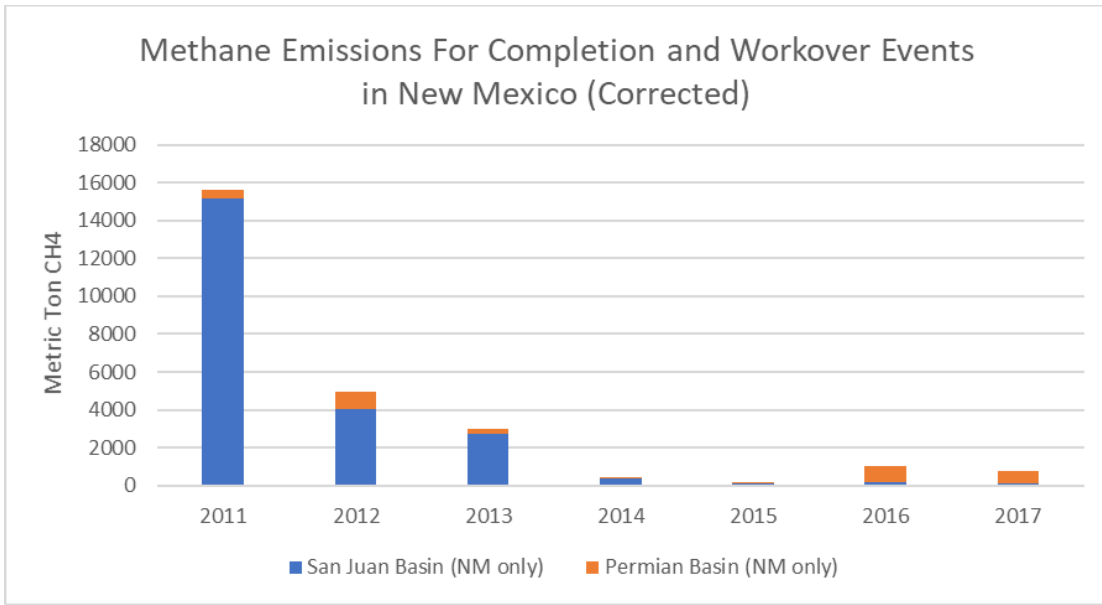

How have states and the federal government reduced emissions/waste from this equipment or process historically? In addition, please identify voluntary reductions achieved whether or not they were in response to a regulatory action/requirement.

Voluntary reductions were achieved by operators as reported to EPA’s Natural Gas Star program and have been discussed earlier in this document.



Completions following hydraulic fracturing have to meet the emission standards outlined in federal NSPS regulations. NSPS OOOO regulations (2012) addressed emissions from gas wells. NSPS OOOOa regulations (2015) added oil well requirements for completions beginning November 2016.

The requirements for completions in the NSPS OOOOa regulations can be found at [https://ecfr.io/Title-40/sp40.8.60.oooo\\_0a](https://ecfr.io/Title-40/sp40.8.60.oooo_0a).

The regulations related to well completions are at 40 CFR §60.5375a. In addition, the federal register notice contains information about the requirements for completions.

<https://www.govinfo.gov/content/pkg/FR-2015-09-18/pdf/2015-21023.pdf>

In general, the regulations classify completions at four categories of wells:

1. Nonwildcat and non-delineation wells
2. Wildcat and delineation wells
3. Low pressure wells
4. Low gas-oil ratio (GOR) wells

#### Non-wildcat and non-delineation wells

For these wells, the flowback period of a well completion has been defined as consisting of two distinct stages, the “initial flowback stage” and the “separation flowback stage.” The initial flowback stage begins with the onset of flowback and ends when the flowback is routed to a separator. Routing of the flowback to a separator is required as soon as a separator is able to function (i.e., the operator must route the flowback to a separator unless it is technically infeasible for a separator to function). Any gas in the flowback prior to the point at which a separator begins functioning is not subject to control. The point at which the separator can function marks the beginning of the separation flowback stage. During this stage, the operator must do the following, unless technically infeasible to do so as discussed below: (1) Route all salable quality gas from the separator to a gas flow line or collection system; (2) re-inject the gas into the well or another well; (3) use the gas as an onsite fuel source; or (4) use the gas for another useful purpose that a purchased fuel or raw material would serve. If the operator assesses all four options for use of recovered gas, and still finds it technically infeasible to route the gas as described, the operator must route the gas to a completion combustion device with a continuous pilot flame and document the technical infeasibility assessment. No direct venting of gas is allowed during the separation flowback stage unless combustion creates a fire or safety hazard or can damage tundra, permafrost or waterways.

#### Wildcat and Delineation wells

A wildcat well, also referred to as an exploratory well, is a well drilled outside known fields or is the first well drilled in an oil or gas field where no other oil and gas production exists. A delineation well is a well drilled to determine the boundary of a field or producing reservoir.

For these wells regulations require either (1) routing all flowback directly to a completion combustion device with a continuous pilot flame (which can include a pit flare) or, at the option of the operator, (2) routing the flowback to a well completion vessel and sending the flowback to a separator as soon as a separator will function and then directing the separated gas to a completion combustion device with a continuous pilot flame. For option 2, any gas in the flowback prior to the point when the separator will function is not subject to control. In either case, combustion is not required if combustion creates a fire or safety hazard or can damage tundra, permafrost or waterways.

#### Low Pressure wells

Low pressure well means a well that satisfies at least one of the following conditions: (1) The static pressure at the wellhead following fracturing but prior to the onset of flowback is less than the flow line pressure at the sales meter; (2) The pressure of flowback fluid immediately before it enters the flow line, is less than the flow line pressure at the sales meter; or (3) Flowback of the fracture fluids will not occur without the use of artificial lift equipment.

Regulatory standards for low pressure wells are the same as that for a wildcat well.

#### Low GOR wells

While subject to the rule, wells with a GOR of less than 300 scf of gas per stock tank barrel of oil produced have no well completion requirements. The reason for the proposed threshold GOR of 300 is that based on industry experience separators typically do not operate at a GOR less than 300. Though in theory any amount of free gas could be separated from the liquid, in reality this is not practical given the design and operating parameters of separation units operating in the field.

A majority of the wells in New Mexico that are undergoing completions at this time fall into the non-wildcat and non-delineation wells and the full requirements of the NSPS regulations, i.e., REC and combustion devices apply to these wells.

#### Use of combustion devices

On Pages 56628 and 56629 of the Federal Register notice (see reference below) EPA has discussed the infeasibility of traditional combustion devices such as flares or enclosed combustion devices because the flowback following hydraulic fracturing consists of liquids, gases and sand in a high-volume, multiphase slug flow.

<https://www.govinfo.gov/content/pkg/FR-2015-09-18/pdf/2015-21023.pdf>

What are examples of process changes/modifications that reduce or eliminate emissions/waste from this equipment or process?

Some operators have been voluntarily practicing reduced-emission completions for this source over the past several years. These reductions have been reported to the EPA Natural Gas Star program:

[https://www.epa.gov/sites/production/files/2016-06/documents/reduced\\_emissions\\_completions.pdf](https://www.epa.gov/sites/production/files/2016-06/documents/reduced_emissions_completions.pdf)

<https://www.epa.gov/sites/production/files/2017-09/documents/greencompletions.pdf>

Furthermore, federal requirements apply to all new completions. While there are exemptions from the full REC requirements for some types of completions it would be technically infeasible to extend the full REC requirements to exploratory, low-pressure, or low GOR wells.

**Technology Alternatives:**

List of technology alternatives with link to information or contact information for the company/developers.

Name/Description of Technology	Link (and contact info for company if available)	Availability	Feasibility	Cost Range (choose one)
		In use <u>or</u> in development		Low Medium High

Would new technology or equipment be needed to reduce methane emissions?

As discussed earlier most well completions are subject to the NSPS REC requirements. Additional control requirement for non-wildcat and non-exploratory wells are not easily identifiable. In addition, at this stage, it is not evident that there are technology options available to extend the full REC requirements to exploratory, low-pressure, or low-GOR wells.

What technology alternatives exist to reduce or detect emissions?

At this stage, it is not clear what additional technology alternatives exist to reduce emissions further from these wells.

What are the pros and cons of the alternatives?

NA

What is needed and available for new wells?

NA

What is needed and available for existing wells?

NA

What technology alternatives exist for this equipment or process itself?

NA

What are the pros and cons of the alternatives?

NA

### **Costs of Methane Reductions:**

What is the cost to achieve methane emission reductions?

NA

What would be the implementation cost?

For new wells?

NA

For existing wells?

NA

Are there low-cost solutions available?

NA

If a solution is high-cost, why is that the case?

NA

Are there additional technical analyses needed to refine benefits/costs estimates?

NA

## **3. IMPLEMENTATION**

For each piece of equipment or process, please consider the following questions and add other relevant information. If relevant, please identify if the answers are different for large company and small company requirements or are different for well type or basin.

### **Implementation Feasibility:**

What is the feasibility of implementation (availability of required technology or contractors, potential permitting requirements, potential for innovation)?

Reduced emission completion technology has been required for all gas completions since 2012 and for all completions since 2016 with limited exceptions outlined in the regulations. This is an accepted process and is readily available for most completions across the country.

What is the useful life of equipment?

Completion activities typically last from several days to several weeks. Depending upon the specific circumstances, operators have the option of using either (permanent) equipment installed for production purposes or rental equipment. If rental, operators source this equipment for the expected duration of completion activities.

What are the maintenance and repair requirements for equipment required for methane reduction?

The separators and any temporary equipment including frac tanks is sourced by the operator prior to the commencement of flowback following completion activities. Perhaps the most critical aspect of the flowback period is the necessity to remove sand using an effective sand separator to prevent damage to downstream equipment.

How would emissions be detected, reductions verified and reported?

Operators continue to report emissions from flowback activities in accordance with EPA GHG reporting program.

## 4. CHALLENGES AND OPPORTUNITIES TO ACHIEVE METHANE REDUCTION IN NEW MEXICO

For each piece of equipment or process, please consider the following questions and add other relevant information. If relevant, please identify if the answers are different for large company and small company requirements or are different for well type or basin.

What regulatory gaps exist for this equipment or process? Are there regulatory gaps filled by the proposed implementation?

As discussed earlier, NSPS standards apply to essentially all completions across the country. Due to technical considerations, wildcat, low-pressure, and low-GOR wells are not required to meet the same standards as non-wildcat and non-delineation wells. For technical feasibility reasons, it is important to have these different standards for completions at these special categories of wells. EPA considered and ultimately did not require prior approval for the technical feasibility exemptions for reasons discussed in the previously referenced preamble to the NSPS OOOOa regulations.

EPA requires operators to record the basis for a claim of technical infeasibility to comply with the reduced emission completion requirement, and to provide the recorded information to EPA in an annual

compliance report. 40 C.F.R. Section 60.5420a(c). There is no requirement that operators notify EPA, or the delegated state agency, prior to claiming an exception. One potential improvement to the federal requirements would be for the state to require operators to notify the state prior to claiming an exception from the reduced emission completion requirement. The notice could require the same information EPA currently requires operators record as the basis for the exception claim. The state could require approval of an exception claim prior to completions commencing. This would provide more information to the state as to how many operators are claiming exceptions, and the reasons for such claims. Additional oversight as to the grounds for exception requests could lead to additional emission reductions were the state to find that some exception requests are not warranted (e.g., increased coordination between upstream and midstream operators prior to drilling may lead to the availability of gas pipeline infrastructure being in place prior to completions, thereby making reduced emission completions technically feasible).

Other considerations or comments (e.g. particular design or technological challenges/opportunities, non-air environmental impacts, etc.):

NA

## 5. COMPLETIONS, RECOMPLETIONS AND STIMULATIONS - PATH FORWARD<sup>180</sup>

	OPTIONS	DESCRIPTION AND LINK TO INFORMATION IF AVAILABLE. PLEASE LIST THE BENEFIT THAT COULD BE ACHIEVED THROUGH THIS OPTION AND ANY DRAWBACKS OR CHALLENGES TO IMPLEMENTATION	EMISSIONS REDUCTIONS ARE EASY TO ACHIEVE AND ARE COST EFFECTIVE  1 = EASY 5 = HARD	REPORTING, MONITORING AND RECORDING OPTIONS, INCLUDING REMOTE DATA COLLECTION	IS THIS OPTION HELPFUL IN THE SAN JUAN BASIN, PERMIAN BASIN OR BOTH
9.1	Existing federal NSPS requirements adequately address the completion activities in NM.	Federal regulations create a set of common standards that are applicable for completion activities in New Mexico where both producing basins (Permian and San Juan) each straddle two states.	1 2 3 4 5	Continue with the requirement to report emissions in accordance with EPA's GHG reporting program.	San Juan  Permian  Both
<p><b>COMMENT</b></p> <p>A. As indicated in the Completions document, emissions from this activity are a small percent of total methane emissions. In order to get the necessary reduction, it would be more practical to focus on sources contributing more to the methane emissions. [page 267]</p> <p>B. Continue to allow flaring when technically infeasible to conduct a Reduced Emission Completion. [page 262]</p> <p>C. Data from operator's failure to capture methane emissions [page 263] in completions/recompletions are unknown—therefore comment A. above is unfounded [page 267]. Every effort is being made to capture emissions from</p>			<p><b>SUGGESTION TO MAKE THIS OPTION MORE WORKABLE:</b></p>		

<sup>180</sup> The format of the Path Forward table evolved over the course of the meetings as the group tried to identify the best method for capturing the most useful information. As a result, there is some variation in the table headers from topic to topic in the final consolidated report.

	<p>smaller sources of methane emissions through the LDAR process. However, completions/recompletions may very well be in excess of volumes we are actively seeking to stop with LDAR; and we should pursue completions/recompletions as a significant source of methane pollution. More complete methane emission data regarding completions/recompletions must be collected before reaching the conclusion that the current NSPS regulations are adequate. In fact, Expert Presentation by Dr. Robert Balch suggests that methane emission data reported by operators is underestimated and incomplete <a href="https://www.env.nm.gov/wp-content/uploads/sites/15/2019/08/Flaring-and-Venting-Stats-by-District-9-27-19.pdf">https://www.env.nm.gov/wp-content/uploads/sites/15/2019/08/Flaring-and-Venting-Stats-by-District-9-27-19.pdf</a>.</p>									
9.2	<p>Codify existing federal regulations to protect against possible roll-back.</p>	<p>NMED should not rely on any existing federal regulations, given uncertainty as to what might be repealed. We should codify existing federal regulations and take steps that go beyond OOOOa to further cut emissions.</p>	1	2	3	4	5	San Juan	Permian	Both
	<p>COMMENT</p> <p>A. There is no indication that OOOOa regulations are being rolled back for oil and gas production sources in general and for completions in particular.</p> <p>B. Federal environmental protections including those for methane emission reductions are actively being rolled back at this time—continuing a federal record since 2017 of dismantling both EPA and BLM regulations. There is no indication that current federal policies to eliminate methane regulations will cease.</p>		<p>SUGGESTION TO MAKE THIS OPTION MORE WORKABLE:</p>							
9.3	<p>Eliminate “Technical Infeasibility” Exemption where infeasibility could have been recognized in advance.</p>	<p>NSPS Subpart OOOOa allows operators to obtain an exemption from green completion requirements on technical infeasibility grounds even when the grounds for the exemption (e.g., lack of gathering lines) are known in advance. See 81 FR 35852. In adopting this rule, EPA considered but rejected comments urging the agency to disallow technical infeasibility exemptions in these cases. Id. The agency also considered but rejected comments suggesting that the agency require advanced</p>	1	2	3	4	5	San Juan	Permian	Both



		<p>notification of an operator’s decision to invoke the technical infeasibility. Id.</p> <p>As EPA’s discussion indicates, in many cases operators know in advance that it is not feasible to comply with EPA’s green completion requirements due to lack of gathering lines, right of way issues, or similar factors. In these cases, there is a technically feasible alternative to wasting the gas: delay drilling until it is technically feasible to perform a green completion.</p>			
<p>COMMENT</p> <p>A. Wells may be connected to pipeline but may still need to flare due to capacity or pressure issues. There are technical infeasibilities that arise even when capture options have been planned, making the need to flare difficult to predict ahead of time. Abrupt shut-ins or restricted well flow can cause formation damage to wells and result in underground waste. [page 274]</p> <p>B. Sometimes technical infeasibility issues can come up very late in the process despite operator plans (GCP submittal for example) to connect to a gathering line and to route the gas to sales. For example, pipeline may have operational issues on the day of the completion activity. Or there may be a right of way issue that prevents a connection at the last minute. Or the gas quality may prevent routing the gas into the gas pipeline. [page 262] There can be unforeseen circumstances which cannot be predicted in "advance". The option needs to make provisions for unforeseen and unpredictable circumstances despite advanced planning.</p> <p>C. The comment B. (above) misinterprets the scope of 8.3 PATH FORWARD. To discredit the PATH FORWARD, the Comment cites instances of flaring that are “difficult to predict ahead of time” while this PATH FORWARD specifically refers to instances where infeasibility could have been recognized “in <i>advance</i>.”</p>		<p>SUGGESTION TO MAKE THIS OPTION MORE WORKABLE:</p>			

	<p>D. Comment B. (above) fails to consider that flaring events will be easier to predict with increase of data research and multiple options to flaring exist as outlined in detail in <a href="#">Expert Presentations</a>.</p> <p>E. Comment B. (above) assumes that state agency resources will not increase in the future. This assumption is contrary to recent political climate justice trends in New Mexico, and also to consistent historical evidence of technological and process solutions to existing problems after regulations have been put in place, i.e., D.D.T. 1950's <a href="https://www.epa.gov/ingredients-used-pesticide-products/ddt-brief-history-and-status">https://www.epa.gov/ingredients-used-pesticide-products/ddt-brief-history-and-status</a> and lead in gasoline 1975 <a href="https://archive.epa.gov/epa/aboutepa/epa-takes-final-step-phaseout-leaded-gasoline.html">https://archive.epa.gov/epa/aboutepa/epa-takes-final-step-phaseout-leaded-gasoline.html</a></p>				
9.4	<p>NM state rule that contains the following components for all completions, re-completions, and stimulations:          Provide notice prior to completion/re-completion/stimulation (required)</p>	<p><i>If operator <u>has</u> monitoring equipment with data recording on site, notice must be made <b>two (2) days</b> prior to completion/re-completion/stimulation. Data must be submitted within 48 hours.</i></p> <p>OR</p> <p><i>If operator <u>does not</u> have monitoring equipment with data recording on site, notice must be provided <b>fifteen (15) days</b> prior to completion/re-completion/stimulation</i></p>	2	<p>Monitoring required using portable combined <a href="#">FID/PID</a> toxic vapor analyzer with data logging technologies or another technology capable of measurement within acceptable parameters such as <a href="#">FTIR/laser</a> or other <a href="#">innovative and</a></p>	Both

				<a href="#">emerging technologies</a> . <sup>181</sup> Cost for a <a href="#">TVA2020 FID/PID</a> unit starts at <a href="#">\$10,300</a> . <sup>182</sup>
COMMENT			SUGGESTION TO MAKE THIS OPTION MORE WORKABLE: C. Mirror notice requirements already used for drilling operations which would provide for	

**Table 1:** Summary of the technologies participating in the Stanford/EDF Mobile Monitoring Challenge. DOI: <https://doi.org/10.1525/elementa.373.t1>

Company	Platform Type	Sensor Type/Species Measured	Survey Method	Survey Speed <sup>a</sup> (mph)	Survey Height (m)
ABB/ULC Robotics	Drone	Cavity-enhanced laser absorption spectroscopy – Methane	Modified raster scan (wind responsive)	2–5	5–10 m
Advisian	Helicopter	Laser absorption spectroscopy – methane/ethane	Upwind/Downwind transects with sample tube	2–5	15–20 m
Aeris Technologies	Vehicle	Laser absorption spectroscopy – methane, ethane, water-vapor	Fence-line around equipment groups, facility	~10	1–2 m
Baker Hughes (GE)	Drone	Laser absorption spectroscopy – methane	Concentric circles around equipment	~5	5–10 m
Ball Aerospace	Plane	Airborne differential LIDAR – methane	Fly-overs (multiple passes)	~115	~1000 m
Heath Consultants Inc.	Vehicle	Off-axis integrated cavity output spectroscopy – methane, ethane	Fence-line around equipment groups, facility	~10	~1–2 m
Picarro	Drone and Vehicle	Cavity ringdown spectroscopy – methane, ethane, water-vapor	Upwind/Downwind transects	2–5	5–10 m
Seek Ops Inc.	Drone	Laser absorption spectroscopy – methane	Raster scan, with flux plane mapping	2–5	1–3 m
U Calgary	Vehicle	Open-path laser spectroscopy – methane	Fence-line and highway-based screening	~10 (fence-line) 30–50 (highway)	2–3 m
U Calgary and Ventus Geospatial	Drone (fixed-wing)	Open-path laser spectroscopy – methane	Multiple downwind plume transects	30–40	28–124 m

<sup>181</sup> Some technologies were limited in their speed due to speed-limits at the METEC test-site (10 mph).

<https://doi.org/10.1525/elementa.373.t1>

<sup>182</sup> This price quote is from one commercial vendor, LDAR Solutions. Most distributors of this technology only offer quotes directly to a purchasing company, which generally results in a lower per-unit price.

	<p>A. It is not clear how this would actually reduce emissions. It will be helpful to have emission reductions quantified to warrant changing the existing notification requirements. [page 275]</p> <p>B. At this time, actual methane emissions from completions/recompletion amounts have not been quantified or made public. The Colorado notification requirement encourages operators to have methane detection equipment in place as shown in Table 1 (<a href="#">DOI link</a>).for the purpose of determining pollution volumes. Until such time that volumes have been established, emission reductions will be impossible to quantify. (See 8.1 above). Nonetheless, this PATH FORWARD encourages a methane-reducing practice. A lack of complete data does not justify the failure to promote gas-capture practices. Expert Presentation by Dr. Robert Balch suggests that methane emission data reported by operators is underestimated and incomplete <a href="https://www.env.nm.gov/wp-content/uploads/sites/15/2019/08/Flaring-and-Venting-Stats-by-District-9-27-19.pdf">https://www.env.nm.gov/wp-content/uploads/sites/15/2019/08/Flaring-and-Venting-Stats-by-District-9-27-19.pdf</a>.</p>			<p>consistency in regulations, familiarity for both operating and OCD field personnel, and reduced paperwork. Requirements are verbal notice to the appropriate OCD District Office prior to spud, then prior to cementing operations with minimum time frames. Same could be done for verbal notice prior to moving in on completion operations and prior verbal notice before stimulation work. Verbal notice dates and times are referenced on appropriate C-103 forms. [page 278]</p>	
9.5	<p>NM state rule that contains the following components for all completions, re-completions, and stimulations:</p> <p style="padding-left: 40px;">No venting exceptions during completion/re-completion/stimulation</p>	<p>Multiple additional options are available to operators during completions/re-completions/stimulation of a well that make any venting unnecessary: <a href="#">CNG in a box</a>; <a href="#">Capture and conversion to NGL (mobile refrigeration skid)</a>; <a href="#">reduced emissions completions</a>.</p>	3 - 4	<p><a href="#">See innovative and emerging technologies</a></p>	Both
	<p>COMMENT</p> <p>A. Generally, there is not a large amount of gas production during the completions phase. [page 267] Conversion to sales options (CNG, NGL) require both an adequate supply of gas and sales quality gas which may not be present during completions. [page 262] Capture of the gas as CNG/NGL would be prohibitively expensive given the short deployment and small amount of captured gas. Equipment availability is also very limited.</p> <p>B. The comment A. above incorrectly asserts that completions are not a significant source of methane emissions (See comments in 8.1 and 8.4). Conversion of</p>		<p>SUGGESTION TO MAKE THIS OPTION MORE WORKABLE:</p>		

	<p>flowback to sales have an established record of success. Many options exist (Natural Gas STAR program studies: (1) <a href="https://www.epa.gov/sites/production/files/2016-06/documents/reduced_emissions_completions.pdf">https://www.epa.gov/sites/production/files/2016-06/documents/reduced_emissions_completions.pdf</a> (2) <a href="https://www.epa.gov/sites/production/files/2017-09/documents/greencompletions.pdf">https://www.epa.gov/sites/production/files/2017-09/documents/greencompletions.pdf</a> (3) <a href="http://www.ipieca.org/resources/energy-efficiency-solutions/units-and-plants-practices/green-completions/">http://www.ipieca.org/resources/energy-efficiency-solutions/units-and-plants-practices/green-completions/</a> Existing affordable capture technology exists and will be brought to market when regulations require it. [page 267] Equipment was once available, can be again, and at presumed improved function, cost, and availability.</p>				
9.6	<p>NM state rule that contains the following components for all completions, re-completions, and stimulations:</p> <p style="padding-left: 40px;">Limit technical feasibility exceptions for flaring within volumetric limitation</p>	<p>Requests for flaring within volumetric limitations must provide detailed data and costs to be considered. This cost information must include actual equipment costs and estimated operational costs of both capture and flaring for comparison, as well as percentage of expected net yield lost to these costs.</p>	<b>2</b>	<p>Requests could be submitted electronically under a confidential procedure managed by the regulating agency.</p>	Permian
<p><b>COMMENT</b></p> <p>A. Wells may be connected to pipeline but may still need to flare due to capacity or pressure issues. There are technical infeasibilities that arise even when capture options have been planned, making the need to flare difficult to predict ahead of time. Agency resources may be too limited to process requests in a timely manner. Abrupt shut-ins or restricted well flow can cause formation damage to wells and result in underground waste. [page 274]</p> <p>B. NSPS OOOOa requires operators to comply with REC requirements with exemptions for certain wells such as wild cat wells. [page 275] This suggestion would be feasible in those cases where the operator knows "in advance" that it is technically infeasible to route the gas to a pipeline. It is not practical for unforeseen circumstances.</p>			<p><b>SUGGESTION TO MAKE THIS OPTION MORE WORKABLE:</b></p>		

<p>C. Comments A. and B. [above] do not address the fact that increasing the amount of data that industry provides to state agencies is beneficial for the purpose of reducing methane emissions. [page 278]</p> <p>D. Comments A. and B. [above] unwarrantedly rely heavily on a minority of cases (i.e. “capacity or pressure”, instances that are “difficult to predict ahead of time”) that do not represent the majority of flaring requests that the agency processes.</p> <p>E. Comment A. [above] fails to distinguish between a flaring event being “difficult” to predict from a flaring event being impossible to predict; and, additionally, fails to justify why “difficulty” of a methane-reducing measure grants operators a pass on taking precautionary measures.</p> <p>F. Comments A. and B. [above] fail to consider that flaring events will be easier to predict with increase of data research and that multiple options to flaring exist as outlined in detail in <a href="#">Expert Presentations</a>.</p> <p>G. Comment A. [above] assumes that state agency resources will not increase in the future. This assumption is contrary to recent political climate justice trends in New Mexico, and also to consistent historical evidence of technological and process solutions to existing problems after regulations have been put in place, i.e., D.D.T. 1950’s <a href="https://www.epa.gov/ingredients-used-pesticide-products/ddt-brief-history-and-status">https://www.epa.gov/ingredients-used-pesticide-products/ddt-brief-history-and-status</a> and lead in gasoline 1975 <a href="https://archive.epa.gov/epa/aboutepa/epa-takes-final-step-phaseout-leaded-gasoline.html">https://archive.epa.gov/epa/aboutepa/epa-takes-final-step-phaseout-leaded-gasoline.html</a></p> <p>H. We have ample evidence that not only [are operators] failing to capture methane and avoid emitting it during completions/recompletions, they are also venting it (see: Grant-Schreiber study [page 264] “2. Sources of Methane Emissions” — “Existing wells”). NSPS OOOOa says that green completions/R.E.C. will not be vented or flared (40 C.F.R §60.5375a <a href="https://www.govinfo.gov/content/pkg/FR-2016-06-03/pdf/2016-11971.pdf">https://www.govinfo.gov/content/pkg/FR-2016-06-03/pdf/2016-11971.pdf</a>). Extensive evidence of methane emission capture and successful sales line access is listed in comment 8.4 above.</p>	
--	--

# SECTION 10, CROSS-CUTTING PATH FORWARD REPORT

Discussion for MAP members on October 11, 2019

---

## 1. NARRATIVE INTRODUCING THE CROSS- CUTTING PATH FORWARD

The MAP members determined that several Path Forward concepts would apply to more than one piece of equipment or were more over-arching ideas. This report collects those over-arching ideas.

## 2. CROSS-CUTTING - PATH FORWARD<sup>183</sup>

	OPTIONS	DESCRIPTION AND LINK TO INFORMATION IF AVAILABLE. PLEASE LIST THE BENEFIT THAT COULD BE ACHIEVED THROUGH THIS OPTION AND ANY DRAWBACKS OR CHALLENGES TO IMPLEMENTATION	EMISSIONS REDUCTIONS ARE EASY TO ACHIEVE AND ARE COST EFFECTIVE  1 = EASY 5 = HARD	REPORTING, MONITORING AND RECORDING OPTIONS, INCLUDING REMOTE DATA COLLECTION	IS THIS OPTION HELPFUL IN THE SAN JUAN BASIN, PERMIAN BASIN OR BOTH
10.1	Comprehensively Improve Methane Emissions Reporting	<p>Use multiple reporting and monitoring tools to create a comprehensive structure for reporting of methane emissions in the state, tracking emissions reductions, and supporting compliance and enforcement. This system could include:</p> <ul style="list-style-type: none"> <li>• Clearer guidance for OCD C115 reporting on venting and flaring, including venting during completions and recompletions, and data from those forms;</li> <li>• Improvements to OCD Form 129 and Gas Capture Plan data requirements;</li> <li>• Data from NMED's 2020 Minor Source Emission Inventory (and future year inventories);</li> <li>• U.S. GHGRP data;</li> <li>• Satellite Data from Descartes' Labs Data Refinery <a href="https://www.currentargus.com/story/news/local/2019/09/30/new-mexico-works-data-firm-track-oil-and-gas-methane-emissions/3819579002/">https://www.currentargus.com/story/news/local/2019/09/30/new-mexico-works-data-firm-track-oil-and-gas-methane-emissions/3819579002/</a>); and</li> <li>• Data from third parties, such as the newly announced EDF/ Pennsylvania State University/ University of Wyoming/ and Scientific Aviation Permian Basin</li> </ul>	2		BOTH

<sup>183</sup> The format of the Path Forward table evolved over the course of the meetings as the group tried to identify the best method for capturing the most useful information. As a result, there is some variation in the table headers from topic to topic in the final consolidated report.



		<p>methane emissions mapping and monitoring initiative. <a href="https://www.edf.org/media/new-initiative-will-map-and-measure-methane-emissions-across-permian-basin">https://www.edf.org/media/new-initiative-will-map-and-measure-methane-emissions-across-permian-basin</a></p> <p>The system should incorporate mechanisms for using data from satellite, tower, or mobile monitoring sources to identify potential gaps or shortfalls in bottom-up reporting through OCD, NMED, or US GHGRP.</p>			
COMMENT		SUGGESTION TO MAKE THIS OPTION MORE WORKABLE:			
10.2	Consider co-benefits in evaluating methane control mechanisms and work processes	<p>Many control mechanisms and work processes for reducing methane emissions in oil and gas development provide co-benefits, or can be implemented in ways that provide co-benefits. When considering the methane reduction potential of these control strategies and work processes, agencies should also consider co-benefits. These co-benefits can include:</p> <ul style="list-style-type: none"> <li>Reducing emissions of Volatile Organic Compounds and Hazardous Air Pollutants, which cause adverse health impacts for nearby communities. See OOOOa Rulemaking: <a href="https://www.govinfo.gov/content/pkg/FR-2016-06-03/pdf/2016-11971.pdf">https://www.govinfo.gov/content/pkg/FR-2016-06-03/pdf/2016-11971.pdf</a>; John L. Adgate et al., <i>Potential Public Health Hazards, Exposures and Health Effects from Unconventional Natural Gas Development</i>, 48 Environ. Sci. Technol. 8307–8320 (2014), <a href="https://pubs.acs.org/doi/10.1021/es404621d">https://pubs.acs.org/doi/10.1021/es404621d</a>; Clean Air Task Force, <i>Fossil Fumes: A Public Health Analysis of Toxic Air Pollution from the Oil and Gas Industry</i>, <a href="https://www.catf.us/resource/fossil-fumes-public-health-analysis">https://www.catf.us/resource/fossil-fumes-public-health-analysis</a>. Using a multi-pollutant approach to regulation has also been widely supported in public policy literature. See e.g.,</li> </ul>	3		BOTH

		<p>National Research Council, <i>Air Quality Management in the United States</i> (2004)  <a href="https://doi.org/10.17226/10728">https://doi.org/10.17226/10728</a>. Using setback requirements can also prevent localized health harms; an October 2019 Colorado Health Impacts Assessment found that “there is a possibility of negative health impacts at distances from 300 feet out to 2000 feet” near oil and gas facilities. (CPDHE Press Release, <a href="https://www.colorado.gov/pacific/cdphe/news/oil-and-gas-health-risk-study">https://www.colorado.gov/pacific/cdphe/news/oil-and-gas-health-risk-study</a>; Chris Holder et al., <i>Evaluating potential human health risks from modeled inhalation exposures to volatile organic compounds emitted from oil and gas operations</i>, J. AIR &amp; WASTE MANAGEMENT ASSOC., DOI: <a href="https://doi.org/10.1080/10962247.2019.1680459">10.1080/10962247.2019.1680459</a> (2019).</p> <ul style="list-style-type: none"> <li>• Reducing noise pollution, for example by using electric power instead of a combustion engine.</li> <li>• Potential reduced surface impacts such as dust, noise, water contamination, and truck traffic, as well as impact to Tribal Cultural Properties, for example where infrastructure planning processes that require pipelines can be used to reduce surface impacts from truck traffic. See Mark Squillace, <i>Managing Unconventional Oil and Gas Development as if Communities Mattered</i>, 40 VT. L.REV. 525 (2016), <a href="https://scholar.law.colorado.edu/articles/22">https://scholar.law.colorado.edu/articles/22</a>.</li> <li>• Creation of local jobs, for example through leak detection and repair requirements. Marie Veyrier, <i>Datu Research, Find and Fix: Job Creation in the Emerging Leak Detection and Repair Industry</i> (2017), <a href="https://www.edf.org/how-reducing-methane-emissions-creates-jobs">https://www.edf.org/how-reducing-methane-emissions-creates-jobs</a></li> </ul> <p>Effective methane mitigation, in particular relative to infrastructure planning, can, if done right, induce these</p>			
--	--	--	--	--	--

		positive co-benefits to environmental, cultural, and community resources (or, if done wrong, cause negative impacts to these resources).			
	COMMENT		SUGGESTION TO MAKE THIS OPTION MORE WORKABLE:		
10.3	Consider history of technology innovation and deployment to meet regulatory requirements	<p>Historically, innovation and technology deployment has outpaced predictions to meet regulatory requirements. For example, the Clean Air Act’s implementing regulations required electric utilities to control SO2 from power plant smokestacks. Despite industry predictions that the new regulatory requirements would induce high costs, innovation yielded inexpensive scrubbers to satisfy the CAA requirements. Margaret R. Taylor et al., <i>Control of SO2 emissions from power plants: A case of induced technological innovation in the U.S.</i>, 72 TECH. FORECASTING &amp; SOC’L CHANGE 697 (2005), <a href="https://doi.org/10.1016/j.techfore.2004.11.001">https://doi.org/10.1016/j.techfore.2004.11.001</a>.</p> <p>In another case, a study found that performance-based, technology forcing car standards induced substantial innovation in vehicle pollution control technologies. Jaegul Lee et al, <i>Linking Induced Technological Change, and Environmental Regulation: Evidence from Patenting in the U.S. Auto Industry</i>, 40 Research Policy 1240 (2011), <a href="https://www.sciencedirect.com/science/article/pii/S0048733311001193">https://www.sciencedirect.com/science/article/pii/S0048733311001193</a>.</p> <p>At least one study documents how methane control requirements create jobs. “Companies have already experienced 5–30% business growth in states with methane regulations.” Marie Veyrier, Datu Research, <i>Find and Fix: Job Creation in the Emerging Leak Detection and Repair Industry</i> (2017), <a href="https://www.edf.org/how-reducing-methane-emissions-creates-jobs">https://www.edf.org/how-reducing-methane-emissions-creates-jobs</a>.</p>	2		BOTH
	COMMENT		SUGGESTION TO MAKE THIS OPTION MORE WORKABLE:		

10.4	Well Site Electrification: Incentives for Utility Co-ops	<p>Providing a well site with electricity allows operators to implement methane-reducing technologies such as zero-emission dehydrators, electric pumps, and heater treaters. This would require the expansion of service territories for Utility Co-ops surrounding the Permian Basin and San Juan.</p> <p>Expanding utility service territories requires substantial infrastructure investment. But with the right market conditions (i.e. State regulations, financial incentives), this expansion could be economically and environmentally beneficial--especially considering the potential for methane reduction with well site electrification.</p> <p>In the case that the agency would decide to contact utilities regarding this topic, the following is a link with contact information for electric companies relevant to San Juan or Permian Basin: <sup>184</sup></p>			
COMMENT			SUGGESTION TO MAKE THIS OPTION MORE WORKABLE:		
10.5	Require Large Operators to Submit Biennial Progress Reports Detailing Steps Taken to Achieve Net Zero Emission Target	<p>In order to prevent warming in excess of 1.5°C, global net anthropogenic CO2 emissions must fall to zero by around 2050. Intergovernmental Panel on Climate Change, Global Warming of 1.5 °C, <a href="#">Summary for Policymakers</a> at 12.</p> <p>Methane emissions must also be reduced dramatically during the same time-frame. <i>Id.</i> In order to be viable in a carbon constrained world, the oil-and-gas industry must eliminate net GHG emissions within a matter of decades. Large oil and gas operators could be required to submit to NMED a comprehensive status report every 2 years, updating the agency on their progress towards this zero emission target.</p>			
COMMENT			SUGGESTION TO MAKE THIS OPTION MORE WORKABLE:		

<sup>184</sup> [https://docs.google.com/spreadsheets/d/10\\_IOLsuWtE6hEzFe5Tfgcfa8BdcZ3qckMLbr224\\_WT4/edit?usp=sharing](https://docs.google.com/spreadsheets/d/10_IOLsuWtE6hEzFe5Tfgcfa8BdcZ3qckMLbr224_WT4/edit?usp=sharing)

10.6	Utilize Flexible Policy Instruments (Including Market-Based Policies) to Incentivize Continuous Emission Reduction	There are a variety of policy instruments that have been developed to address situations where significant emission reductions from an industry are possible, but it is difficult to mandate the use of specific techniques to achieve these reductions. Examples include company-wide emission reduction targets, fleet-wide averages for particular equipment, cap-and-trade, and emission fees. These instruments can operate in conjunction with equipment, design, and operational standards that are more prescriptive. The agencies should consider combining flexible policy instruments that drive continuous emissions reductions with more prescriptive measures that establish a baseline level of performance for the entire industry.			
COMMENT			SUGGESTION TO MAKE THIS OPTION MORE WORKABLE:		
10.7	Exempt stripper wells	Exempt all identified emissions reduction options (column 1) and be specific to stripper well production. As defined by the Interstate Oil & Gas Compact Commission (IOGCC), a stripper oil well produces 10 BOPD or less, or 60 Mcf/day or less if a gas well. This is an important segment of the oil and gas industry in New Mexico that should not be overlooked, as 66% of the total 57,868 wells (EIA) in this state fall under the IOGCC definition. The majority of wells in New Mexico are marginal wells yet will have the lowest emissions profile and stand to generate the largest increase in emissions generated by mandating quarterly LDAR.			
COMMENT			SUGGESTION TO MAKE THIS OPTION MORE WORKABLE:		
10.8	MOU between state agencies to 1) speed the development of electrical infrastructure to the oilfield	<i>Electricity reliability and voltage requirements-Oilfield equipment power requirements are quite varied ranging from instrumentation at a single well pad needing approximately 35W to operate up to approximately 2,000 kW (note unit change) to operate a single frac/stimulation pump. The power demand required to operate equipment determines if</i>		Metering of gas used for generation (would royalties be due since the gas utilized would alternately be flared).	BOTH

	<p>2) willingness of electrical utilities to accept and manage distributed generation put onto the grid from oilfield sites</p> <p>Impacts suggestions: Conversion of pneumatic controllers, compressors, etc. to electrical power.</p> <p>Use of available associated gas for onsite generation</p>	<p><i>single phase power (household) is adequate or if three phase power (industrial) is necessary. See Infrastructure planning paper for a further detailed description of the status of electrification in the field and needs of the oilfield.</i></p> <p><i>Due to the challenges around the development of adequate power supply to remote locations and the temporary nature of some areas of oilfield demand, many sites are supplied by onsite generation.</i></p> <p><i>Solar or wind installations typically require a back-up power source for reliability purposes. This necessary back-up significantly impacts the economic feasibility of the solutions and may also result in emissions dampening some of the benefit of alternate installation.</i></p> <p><i>Management of distributed oilfield generated power on the grid would offset the load on the existing system, reduce generation from existing power plants, and convert a source of stranded energy.</i></p> <p><i>Management and stability of the grid are critical considerations when considering adding distributed sources of power.</i></p> <p><i>Collection of produced gas in "mini" gathering systems may be necessary to provide a stable source of gas to generators.</i></p> <p><i>Determination of gas royalties and/or payment for power generated would need to be sorted out to maximize economic options.</i></p> <p><i>Expedited right of way for electrical lines would be necessary to maximize generation capability and minimize associated gas flaring.</i></p>		<p>Metering of electrical production.</p>	<p>However, the lack of supporting electrical infrastructure is more predominant in the Permian due to growth in remote locations.</p>
COMMENT			SUGGESTION TO MAKE THIS OPTION MORE WORKABLE:		
10.9	<p>Consider where methane reduction strategies and</p>	<p>Native communities experience unique and disproportionate harms from Oil and Gas production. For example, Oil and Gas Production has impacted Diné society, its structures</p>			

	<p>processes have the potential to reduce negative impacts to native communities, native lifeways, or tribal cultural properties, including through consultation with the NM Department of Indian Affairs</p>	<p>relationships with family, community and ecosystems, and that fracking caused a significant perturbation of practice and reverence of Hozhoo. The NM Health Impact Assessment Report, <i>A Cultural, Spiritual, and Health Impact Assessment of Oil Drilling Operations in the Navajo Nation Areas of Counselor, Torreon, and Ojo Encino Chapters</i>. 2019. Herbert Benally, PhD, and Moroni Benally, MPP, MSPPA.</p> <p><i>Spatial Justice and Indigenous People’ Protection of Sacred Places: Adding Indigenous Dimensions to the Conversation</i>. March, 2017. June L. Lorenzo, PhD, NM Attorney.</p> <p>Moreover, as sovereign nations, Tribal communities are owed government-to-government consultation under federal and state laws and policies. See New Mexico State-Tribal Collaboration Act, NMSA 11-18-1 et seq; Consultation and Coordination with Indian Tribal Governments, Exec. Order 13175 (Nov. 6, 2000).</p> <p>Tribal communities, lifeways, and cultural properties are also protected by numerous federal and state laws. See e.g., New Mexico Cultural Properties Act, NMSA 18-6-1 et seq.; National Historic Preservation Act, 54 U.S.C. § 302706.</p> <p>A number of promising methane reduction technologies and work processes can either harm or benefit Tribal communities, lifeways, and cultural properties. In the process of rulemaking, agencies should consider how regulatory options could harm or benefit Tribal communities, lifeways, and cultural processes, and where possible should require options to be implemented in ways that will reduce harmful effects or secure co-benefits for Tribal Communities, lifeways, and cultural properties. Agencies should consult with Tribes and with the NM Indian Affairs Department to identify potential co-benefits and harms.</p>			
--	---	--	--	--	--

COMMENT		SUGGESTION TO MAKE THIS OPTION MORE WORKABLE:			
10.10	Federal Regulations that may affect some path forwards. Section 106 Tribal consultation. Regional Haze.	<a href="https://www.npi.org/nepa-and-section-106-national-historic-preservation-act">https://www.npi.org/nepa-and-section-106-national-historic-preservation-act</a> This may affect infrastructure. <a href="https://www.epa.gov/visibility/regional-haze-program">https://www.epa.gov/visibility/regional-haze-program</a>			
COMMENT		SUGGESTION TO MAKE THIS OPTION MORE WORKABLE:			
10.11	Navajo Nation Regulations need to be considered regarding paths forward	Proposed Navajo Nation Environmental Protection Agency proposed minor new source regulations. These rules will be a unitary permit. This follows 76. FED. Reg. 38784 (July 1, 2011), 40 CFR sections 49.151-161 Navajo EPA will have proposed rule out for comment in the near future.			
COMMENT		SUGGESTION TO MAKE THIS OPTION MORE WORKABLE:			
10.12	Navajo Nation Aquifer Protection Act affect multiple path forward sections	This regulation needs consideration on Checkerboarded lands. <a href="http://www.navajopublicwater.org/26_NPDWR-2600_Aquifer_Protection-Regulations_Rev.pdf">http://www.navajopublicwater.org/26_NPDWR-2600_Aquifer_Protection-Regulations_Rev.pdf</a>			
COMMENT		SUGGESTION TO MAKE THIS OPTION MORE WORKABLE			
A. Adjustable regulations: Do not pass the point of regulatory diminishing returns. Energy expended and greenhouse gases emitted chasing down small leaks are greater than the environmental impact of the leaks themselves. Repetitive monitoring makes little sense as the percentage of leaking components decreases. This calls for a fresh look at regulatory regimens in light of current sealing and monitoring technologies.					
10.13	Consider incentives / recognition of companies that are meeting / exceeding expectations – differentiate through public recognition	Adjusting behavior in any organization requires application of both positive recognition for those reflecting the behaviors expected as well as negative influence with others who aren't moving quickly enough to meet the new behavioral expectations. Studies show that positive recognition has a greater influence on behavior than negative.	<b>1</b>	It is recommended that a report or portal be created to allow a company that is striving to meet or exceed NM expectations can answer voluntary questions regarding their	<b>BOTH</b>



				proactive work (i.e. more frequent FLIR studies, complete changeout to Viton gaskets, etc.) which is auditable. If those companies achieve a score of X or higher against proactive and voluntary reporting, they would be incentivized through Governor or other governmental recognition of their company in order to promote great behavior and motivate others to strive for this recognition. It would also be good to incentivize this verified good behavior to reduce reporting or other regulatory burdens.	
	COMMENT		SUGGESTION TO MAKE THIS OPTION MORE WORKABLE:		
10.14	Add more detail to the New Mexico Civil Penalty Policy – Appendix D ( <a href="https://www.env.nm.gov/air-quality/civil-penalty-policy/">https://www.env.nm.gov/air-quality/civil-penalty-policy/</a> )	The Texas EHS Audit Privilege Act ( <a href="https://crgtexas.com/2018/03/05/texas-environmental-health-safety-audit-privilege-act/">https://crgtexas.com/2018/03/05/texas-environmental-health-safety-audit-privilege-act/</a> ) is extremely detailed in its design and would allow NMED, OCD and the company to enter an agreement in a much more protected manner. Highly recommend emulating this structure in NM. It is important to note that the Texas RRC has adopted this EHS	<b>1</b>	The Texas Audit Privilege Act has strong guidance which would help NM in objective communication of expectations and also provide clear gates through which a	BOTH

	using the Texas Environmental, Health and Safety Audit Privilege Act (both TCEQ and RRC have adopted this program) as a foundation.	Audit Privilege program in recent years – it was founded within TCEQ.		company must follow to meet its expectations. This would lead to more use of the system.	
	COMMENT		SUGGESTION TO MAKE THIS OPTION MORE WORKABLE:		
10.15	Temporary (< 1 year on site) gen set power allowed to be placed on site in the event line power is not available without forcing NMED permitting staff to write permit for this temporary requirement and requires company to wait up to 120 for this permit modification – with this timing sometimes forcing flaring while waiting on gen set power.	Many states allow the placement of temporary gen set power on a site in the event there are delays in getting line power to a site. This minimizes flaring in the event line power is delayed. Most states allow this and it would have an immediate impact on improving methane capture in New Mexico.	1	Company would be obligated to remove temporary power by end of year. Companies would always prefer to use line power versus gen set power so the financial benefits of getting line power ASAP is the primary driver to get away from gen sets.	BOTH
	COMMENT		SUGGESTION TO MAKE THIS OPTION MORE WORKABLE:		
10.16	Adjustable regulations	Do not pass the point of regulatory diminishing returns. Energy expended and greenhouse gases emitted chasing down small leaks are greater than the environmental impact of the leaks themselves. Repetitive monitoring makes little sense as the percentage of leaking components decreases. The majority of wells in New Mexico are marginal wells yet will have the lowest emissions profile and stand to generate			

		the largest increase in emissions generated by mandating quarterly LDAR. This calls for a fresh look at regulatory regimens in light of current sealing and monitoring technologies.			
	COMMENT		SUGGESTION TO MAKE THIS OPTION MORE WORKABLE:		
10.17	Incorporating the Social Cost of Methane	<p>When state agencies are considering cost-benefit analyses to determine the "economic feasibility" of a certain methane reducing technology, the social cost of methane (SCM) should be taken into account. Methane emissions have externality costs (i.e. perpetuating the climate crisis, damaging public health, harming agriculture yields) that industry does not internalize. Scholarship on this issue suggests that "quantifying these damages to the planetary commons by calculating the social cost of methane (SCM) facilitates more comprehensive cost-benefit analyses of methane emissions control measures and is the first step to potentially incorporating them into the marketplace."</p> <p>Interagency Working Group on Social Cost of Carbon, United States Government, <i>Technical Support Document: Social Cost of Carbon for Regulatory Impact Analysis Under Executive Order 12866</i> (February 2010) (IWG (2010)).</p> <p>Interagency Working Group on Social Cost of Carbon, United States Government, <i>Addendum to Technical Support Document on Social Cost of Carbon for Regulatory Impact Analysis under Executive Order 12866: Application of the Methodology to Estimate the Social Cost of Methane and the Social Cost of Nitrous Oxide (August 2016)</i> (IWG (2016))</p>	2		

		<p>Interagency Working Group on Social Cost of Carbon, United States Government, <i>Technical Support Document: Technical Update of the Social Cost of Carbon for Regulatory Impact Analysis Under Executive Order 12866</i> (August 2016) (IWG (2016)).</p> <p>Hindell, D. T., Fuglestvedt, J. S. and Collins, W. J. (2017) The social cost of methane: theory and applications. <i>Faraday Discussions</i>, 200. pp. 429-451. ISSN 1364-5498 (<a href="http://centaur.reading.ac.uk/72181/">http://centaur.reading.ac.uk/72181/</a>)</p>				
		COMMENT	SUGGESTION TO MAKE THIS OPTION MORE WORKABLE:			
10.18	Require consideration of ambient constant noise level dBA regulation/policy for mechanical, hydraulic, pneumatic, compressors or other devices in sites that are close to residential areas.					
		COMMENT	SUGGESTION TO MAKE THIS OPTION MORE WORKABLE:			
10.19	Increase FTE count and funding at OCD and NMED AQB in order to more effectively implement and enforce methane reduction regulations.	As underlined by the consensus industry, environmental organizations, and state regulators in the 2019 State Review of Oil and Natural Gas Environmental Regulations (STRONGER) <a href="#">New Mexico State Review Report</a> key recommendations 10.2.6 (AQB) and 10.2.6a (OCD), both agencies require increases in full time employee (FTE) counts and funding from the Governor and State Legislature in order to accomplish their statutory duties including the implementation and enforcement of methane waste and pollution reduction regulations. Therefore, effectuating these	3		BOTH	

	<p><u>"Community Ombudsman"</u></p>	<p>increases will be key to realizing these methane reductions going forward.</p> <p>There is a body of existing knowledge on the effect of oil and gas development/production on rural and indigenous communities. An opportunity exists to create additional reference for people who are either impacted by oil and gas development initially or are otherwise challenged by oil and gas production to get advice and references that will help give access to pertinent agencies, speed up response times and help orient them to the challenges ahead.</p> <p>For example, organizations like Earthworks' Oil &amp; Gas Accountability Project and San Juan Citizens Alliance have been providing support to individuals and communities throughout New Mexico living with oil and gas development for over 30 years. These organizations and groups like them could help inform a neutral "community ombudsman" office established by the state to work with those directly affected by oil and gas development to better understand their rights and best practices available to prevent and reduce the impacts caused by development.</p>			
COMMENT		SUGGESTION TO MAKE THIS OPTION MORE WORKABLE:			